

**Federal Transit Administration
Scope & Activity Line Item Codes
Status: APPROVED**

Last Update 03/30/2006

TRANSPORTATION ELECTRONIC AWARD & MANAGEMENT
SCOPE CODE CHART
SCOPE CODES

<i>Category</i>	<i>Description</i>	<i>Code</i>	<i>Sub-Code</i>	<i>Special Instructions</i>
Capital	Bus Rolling Stock	111-00		
	Bus Transitways / Lines	112-00		
	Bus Station Stops & Terminals	113-00		
	Bus Support Equip / Facilities	114-00		
	Bus Electrification / Power Dist.	115-00		
	Bus Signal & Communication Equip	116-00		
	Bus Other Capital Items	117-00		
	Bus Transit Enhancements	119-00		
	Fixed Guideway Rolling Stock (rail)	121-00		
	Fixed Guideway Transitways / Lines	122-00		
	Fixed Guideway Station Stops & Terminals	123-00		
	Fixed Guideway Support Equip / Facilities	124-00		
	Fixed Guideway Electrification / Power Dist.	125-00		
	FG Signal & Communication Equip	126-00		
	Fixed Guideway Other Capital Items	127-00		
	Fixed Guideway Transit Enhancements	129-00		
	New Start Rolling Stock	131-00		} Transitioning out Use these Scopes for Amendments Only.
	New Start Transitways / Lines	132-00		
	New Start Stops & Terminals	133-00		
	New Start Support Equip / Facilities	134-00		
	New Start Electrification / Power Dist.	135-00		
	New Start Signal & Comm. Equip	136-00		
	New Start Other Capital Items	137-00		
	New Start Transit Enhancements	139-00		
} New Start Capital Projects	Guideway & Track Elements	140-10		} New Start Capital Projects Use these Scopes for all new New Start grants/projects regardless of funding source. Use 13.XX.XX ALI's for New Start Vehicles
	Stations, Stops, Term, Intmdl	140-20		
	Support Facilities	140-30		
	Sitework & Special Conditions	140-40		
	Systems	140-50		
	ROW, Land, Existing Imprvmnts	140-60		
	Vehicles	140-70		
	Professional Services	140-80		
	Unallocated Contingency	140-90		
	Finance Charges	141-00		
Operating	Operating Assistance	300-00		
Planning	State Planning & Research	441-00		} <i>Use 44.2X.XX ALIs</i> <i>Use 70.XX.XX ALIs</i> <i>Use 55.XX.XX ALIs</i> <i>Use 50.XX.XX ALIs</i> <i>Use 55.XX.XX ALIs</i> <i>Use 44.2X.XX ALIs</i>
	University Research		441-10	
	Human Resources		441-20	
	Training Fellowship		441-30	
	Research & Development		441-60	
	Metropolitan Planning		441-80	
	Metropolitan Planning	442-00		
	Consolidated Planning Grants	443-00		
Review	Oversight Reviews	510-00		<i>Used only by headquarters.</i>
Research	Research Projects	550-00		<i>Use 55.xx.xx ALIs</i>
Safety & Security	Safety	571-00		<i>Use for Security Supplemental Funding projects only. HQ Use only.</i>
	Security	572-00		
} Scopes for: 5310, 5311, 5316, 5317	Other Program Costs	600-00		<i>Option: Combine Scopes 300, 610, 620, & 630 into a single scope code</i> <i>Use ALI code 11.80.00</i>
	State / Programs Administration	610-00		
5311 only	Project Administration	620-00		<i>Use ALI code 11.79.00</i>
5310, 5311 only	Program Reserve/Category C	630-00		<i>Use ALI code 11.73.00</i>
5311 only	Intercity Bus Transportation	634-00		<i>Use Capital, Operating, or Plnng ALIs</i>
5311 only	Rural Transit Asst Program (RTAP)	635-00		<i>Use 43.5X.XX ALIs</i>
	Sec 5311 and Sec 5310 budgets may also use Capital, Operating, or Planning Scope codes in addition to the special scopes listed in this section.			
See Note *	5310 Projects	641-00		} * Note: Special Categories for 5310, 5316, 5317 projects in 5307 or 5311 Grants
See Note *	JARC Projects	646-00		
See Note *	New Freedom Projects	647-00		

**Federal Transit Administration
Scope & Activity Line Item Codes
Status: APPROVED**

Last Update 03/30/2006

TRANSPORTATION ELECTRONIC AWARD & MANAGEMENT
SCOPE CODE CHART
NON-ADD SCOPE CODES

Non-add Codes	Security Expenditures	991-00	Break out the security related expenses included in the budget - other than 5302(a)(1)(J) items; use the ALI codes from the project budget.
	Tribal Projects	992-00	Use to identify tribal projects under any program.
	Fleet Management	993-00	
	Electronic Fare	994-00	
	Traveler Information	995-00	
	ADA / CAA Increased Federal Share	996-00	
	Transfer of Federal Equity	998-00	
	Contingency Projects	999-00	

**Federal Transit Administration
Scope & Activity Line Item Codes
Status: APPROVED**

Last Update 03/30/2006

TRANSPORTATION ELECTRONIC AWARD & MANAGEMENT
ACTIVITY LINE ITEM CODE CHART
FOR CAPITAL EXPENDITURES

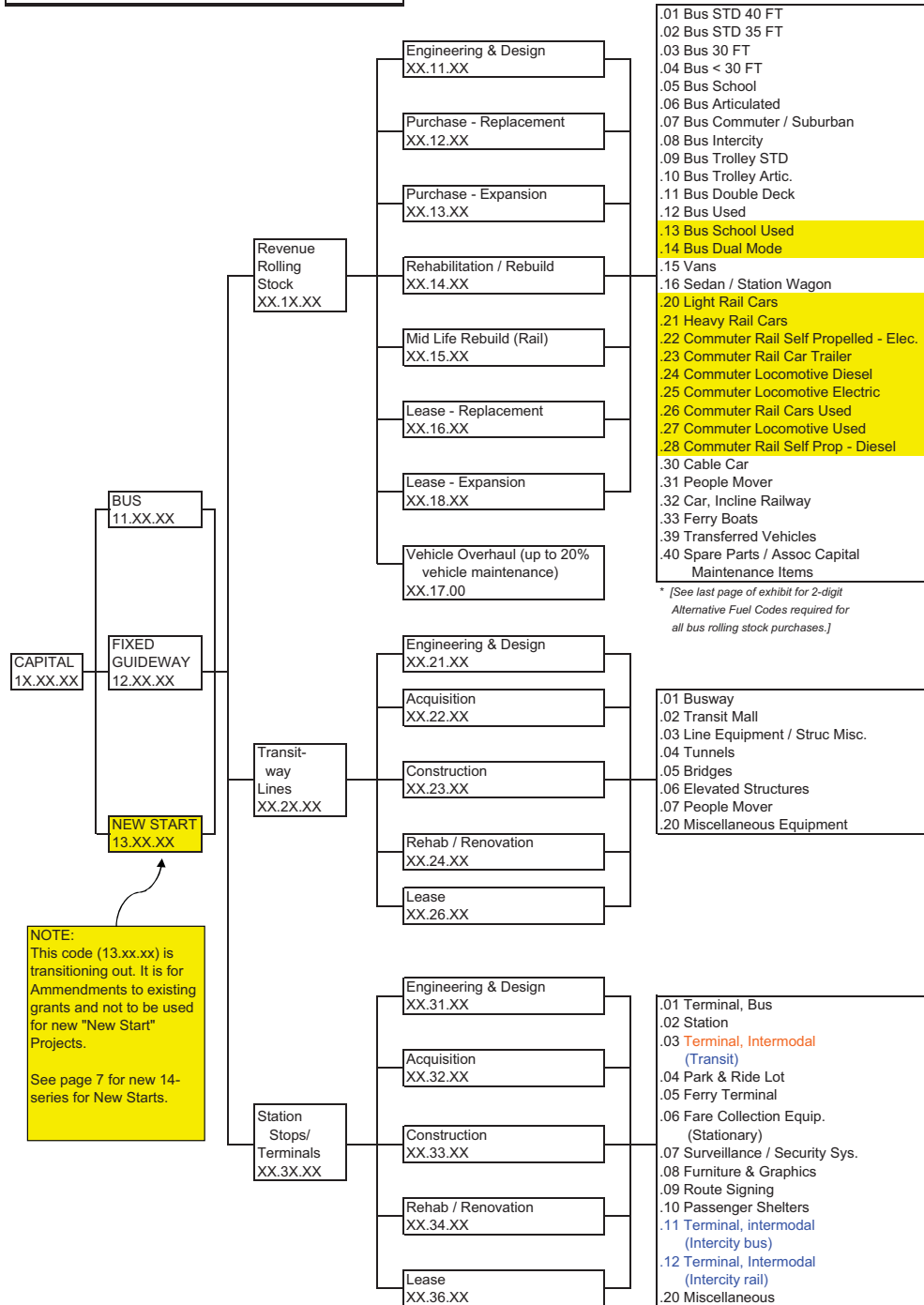

**Federal Transit Administration
Scope & Activity Line Item Codes
Status: APPROVED**

Last Update 03/30/2006

TRANSPORTATION ELECTRONIC AWARD & MANAGEMENT
ACTIVITY LINE ITEM CODE CHART
FOR CAPITAL EXPENDITURES

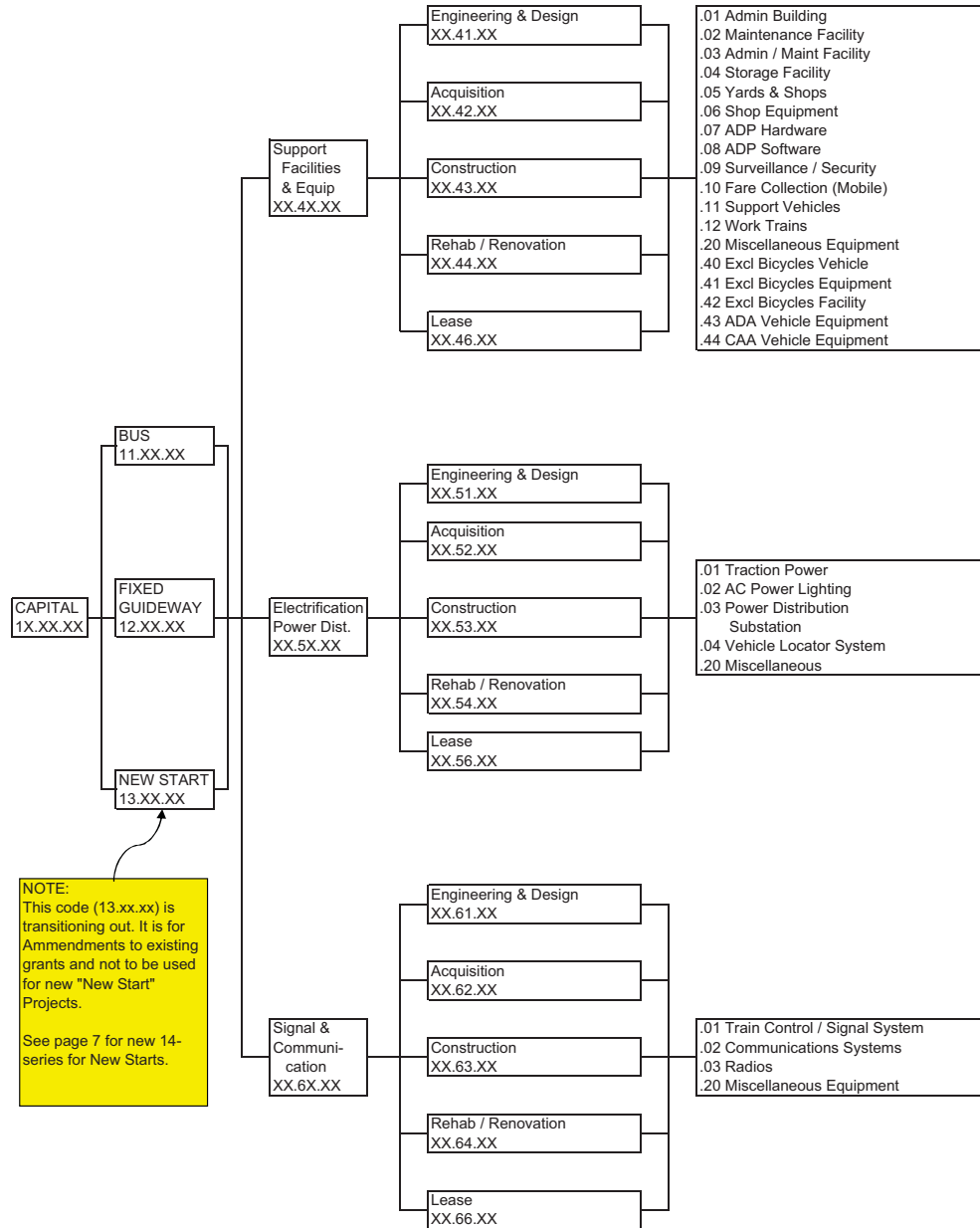

**Federal Transit Administration
Scope & Activity Line Item Codes
Status: APPROVED**

Last Update 03/30/2006

TRANSPORTATION ELECTRONIC AWARD & MANAGEMENT
ACTIVITY LINE ITEM CODE CHART
FOR CAPITAL EXPENDITURES

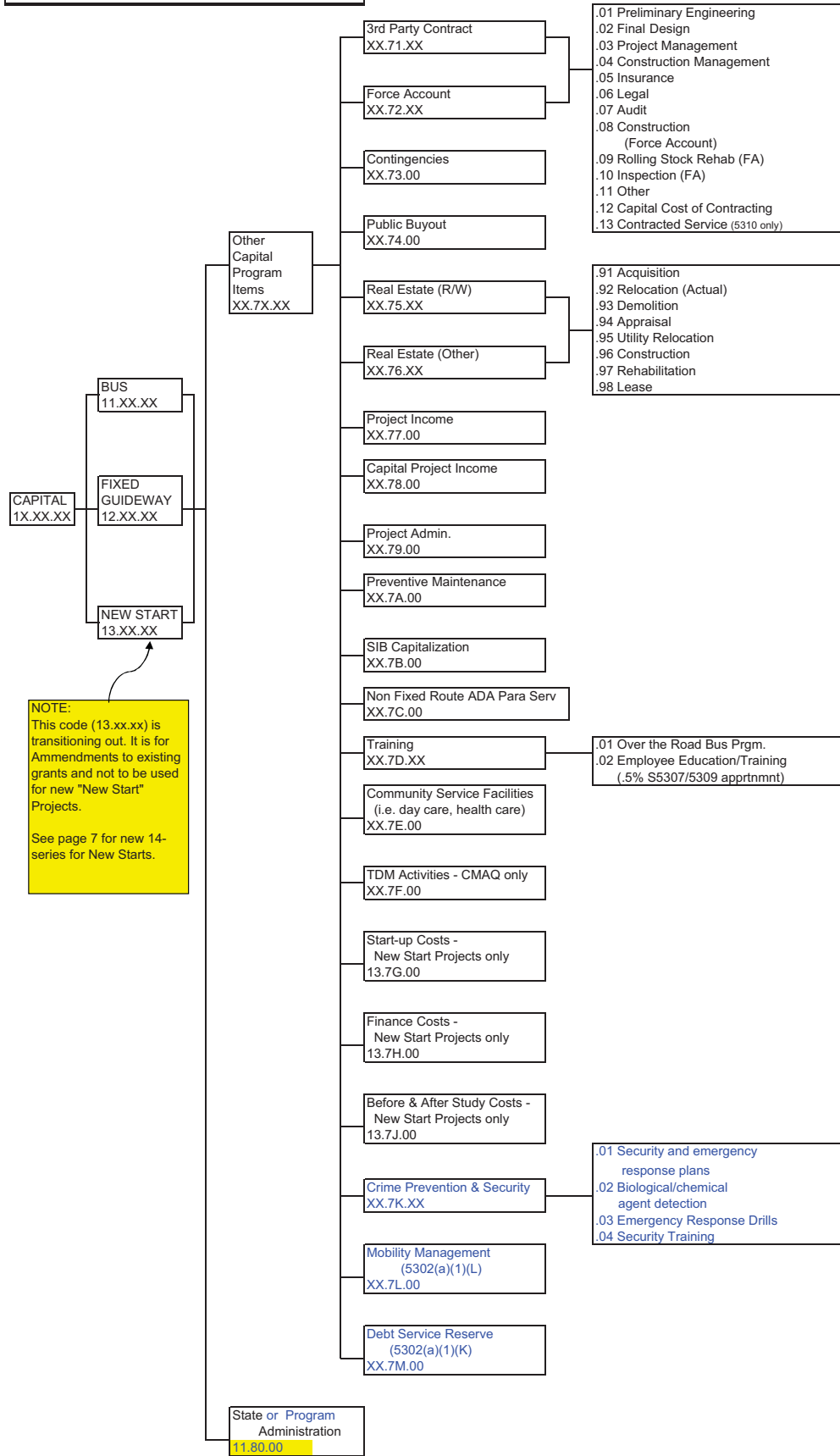

NOTE:
This code (13.xx.xx) is transitioning out. It is for Amendments to existing grants and not to be used for new "New Start" Projects.

See page 7 for new 14-series for New Starts.

**Federal Transit Administration
Scope & Activity Line Item Codes
Status: APPROVED**

Last Update 03/30/2006

TRANSPORTATION ELECTRONIC AWARD & MANAGEMENT
ACTIVITY LINE ITEM CODE CHART
FOR CAPITAL EXPENDITURES

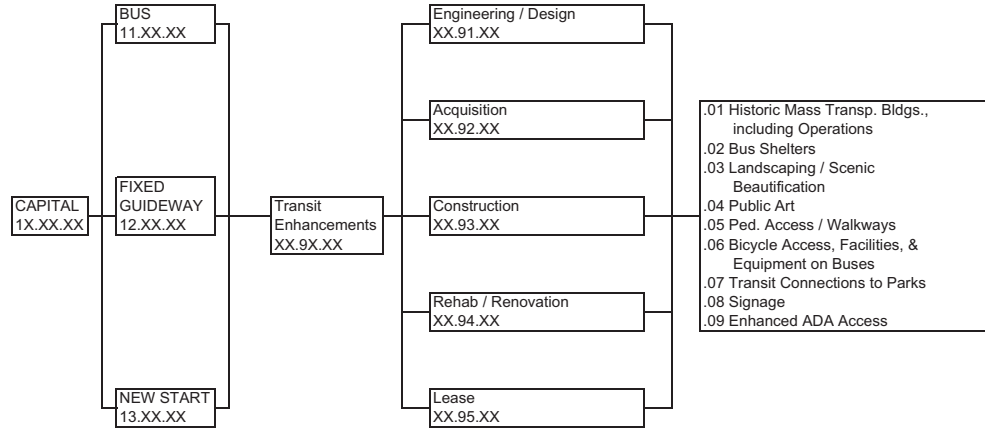

**Federal Transit Administration
Scope & Activity Line Item Codes**

Last Update 03/30/2006

Status: APPROVED

TRANSPORTATION ELECTRONIC AWARD & MANAGEMENT
ACTIVITY LINE ITEM CODE CHART
FOR CAPITAL EXPENDITURES

NOTE: Use these New Start codes for new grants only.

Refer to TPE guidance on use of TEAM Scopes and ALI to match the Standard Cost Categories (SCC) for all New Start grants:

http://www.fta.dot.gov/planning/newstarts/planning_environment_2580.html

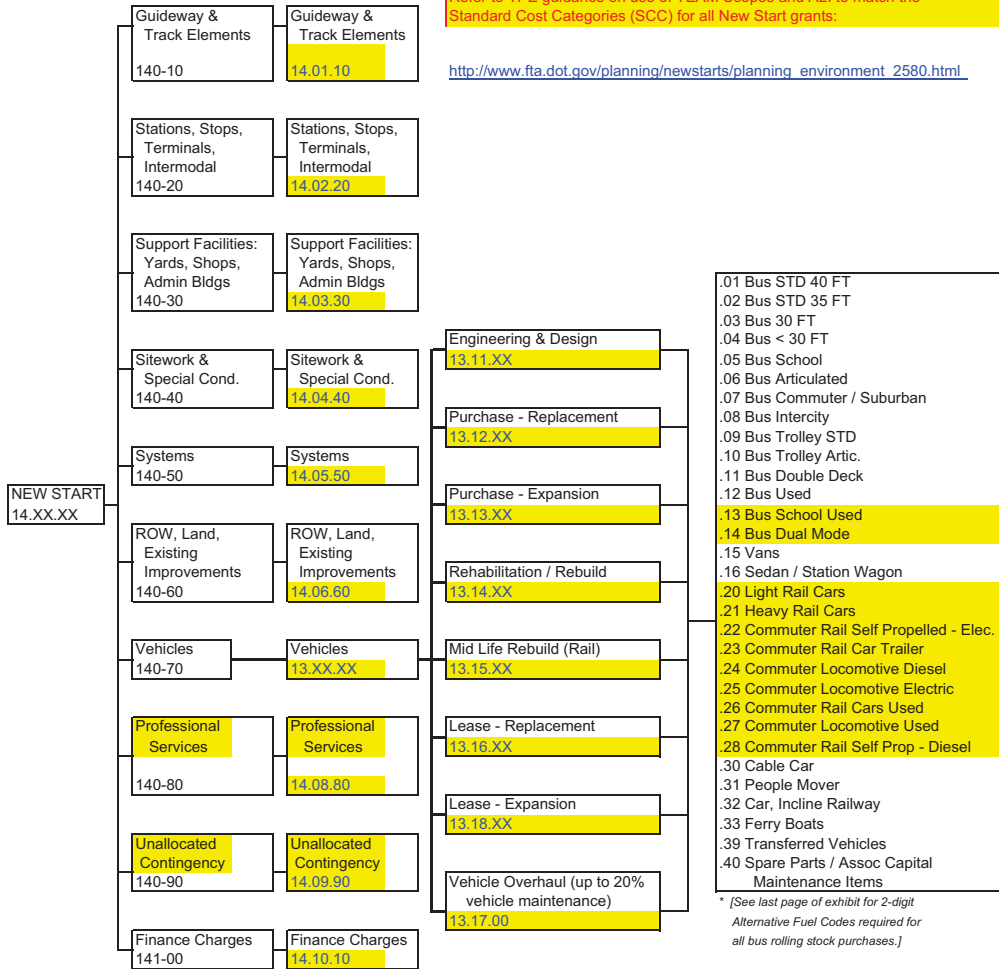

* [See last page of exhibit for 2-digit Alternative Fuel Codes required for all bus rolling stock purchases.]

Federal Transit Administration
Scope & Activity Line Item Codes
Status: APPROVED

Last Update 03/30/2006

TRANSPORTATION ELECTRONIC AWARD & MANAGEMENT
ACTIVITY LINE ITEM CODE CHART
FOR OPERATING EXPENDITURES

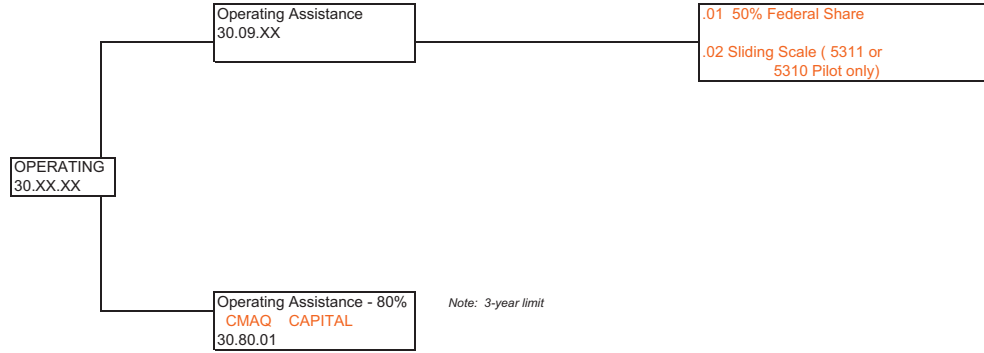

**Federal Transit Administration
Scope & Activity Line Item Codes
Status: APPROVED**

Last Update 03/30/2006

TRANSPORTATION ELECTRONIC AWARD & MANAGEMENT
ACTIVITY LINE ITEM CODE CHART
FOR PLANNING EXPENDITURES

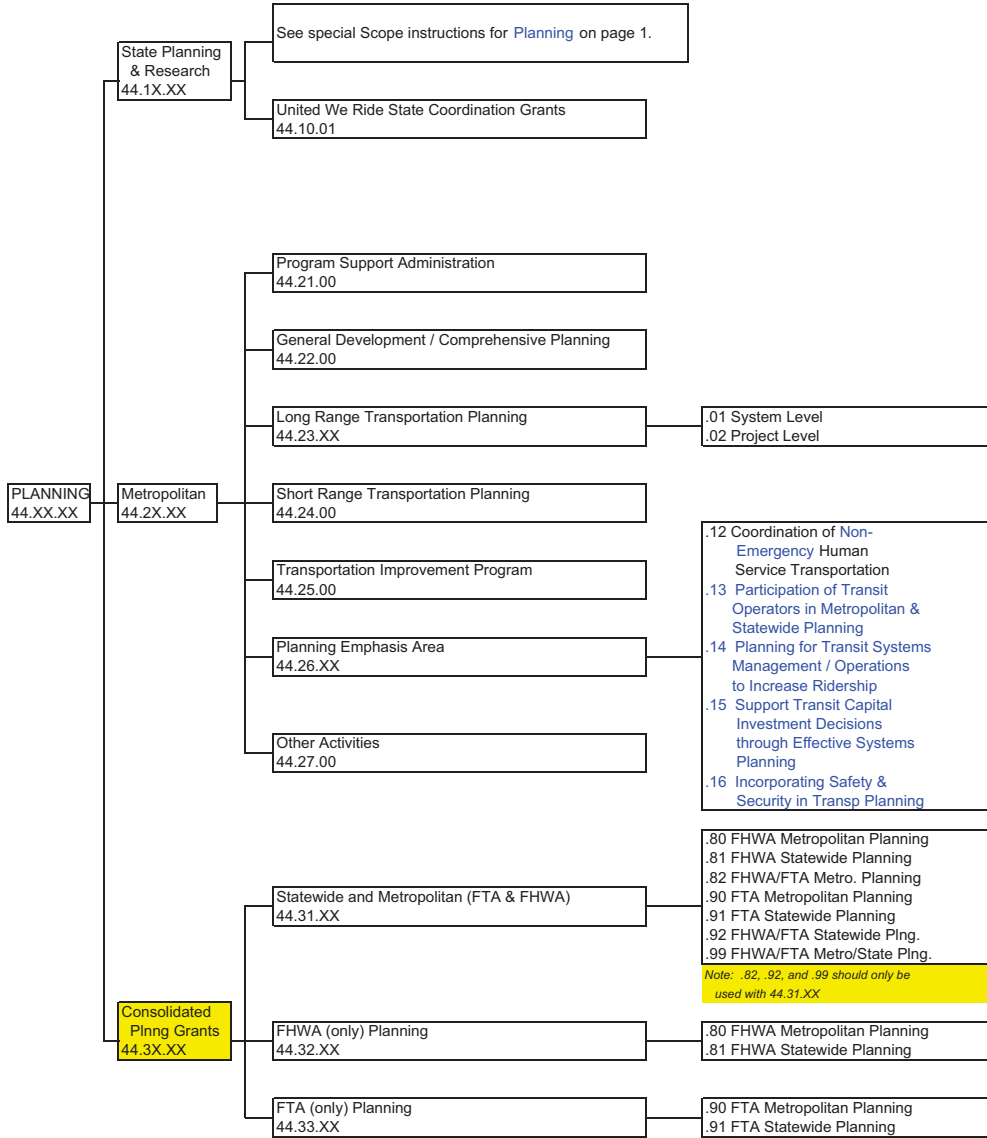

**Federal Transit Administration
Scope & Activity Line Item Codes
Status: APPROVED**

Last Update 03/30/2006

TRANSPORTATION ELECTRONIC AWARD & MANAGEMENT
ACTIVITY LINE ITEM CODE CHART
FOR RTAP AND MANAGEMENT TRAINING

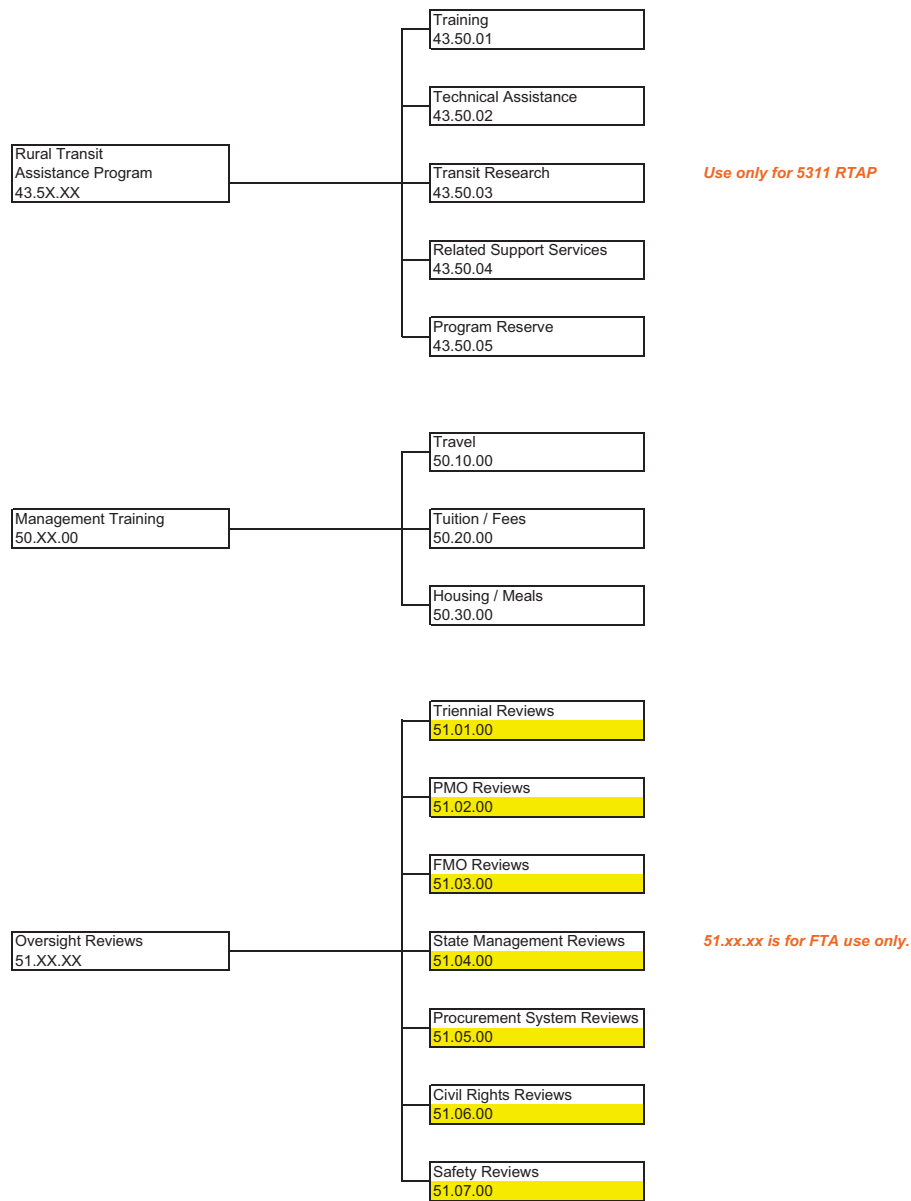

**Federal Transit Administration
Scope & Activity Line Item Codes**

Last Update 03/30/2006

Status: **APPROVED**

TRANSPORTATION ELECTRONIC AWARD & MANAGEMENT
ACTIVITY LINE ITEM CODE CHART
FOR RESEARCH AND OTHER EXPENDITURES

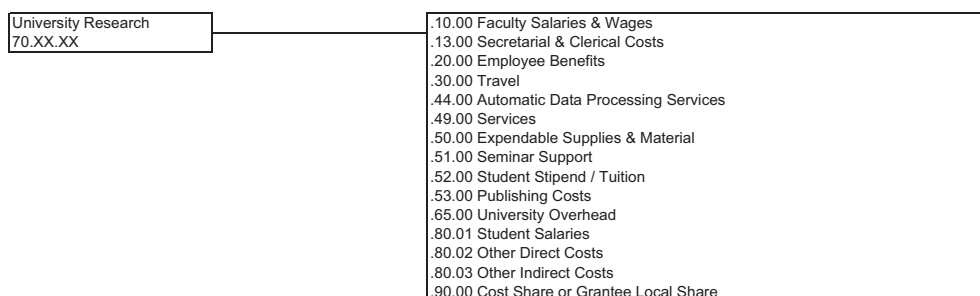
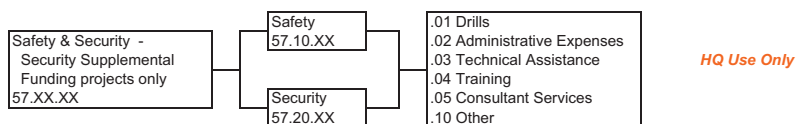
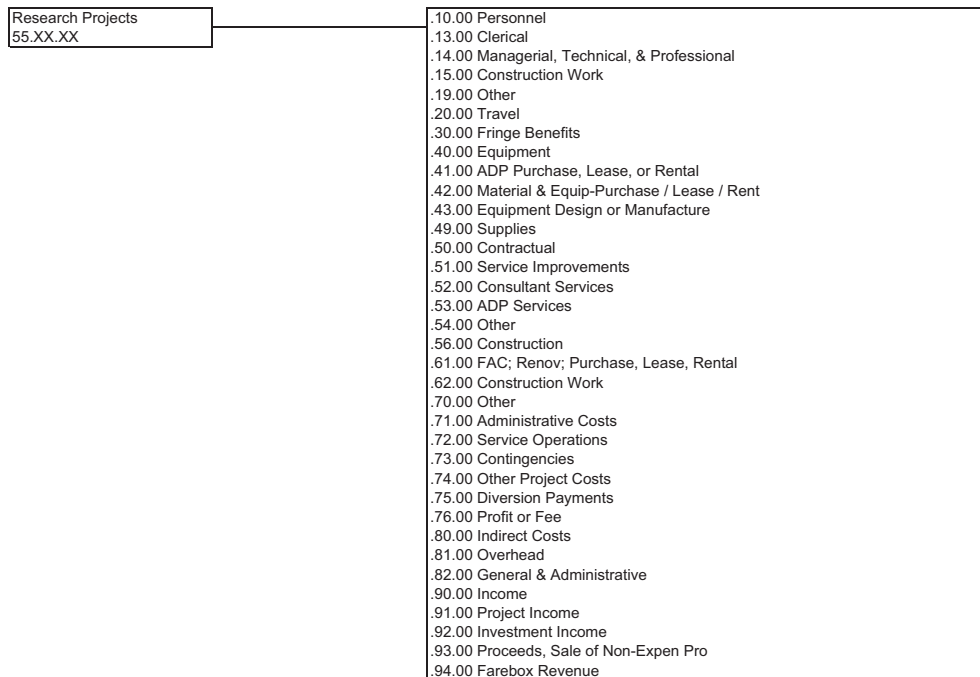

**Federal Transit Administration
Scope & Activity Line Item Codes**

Status: APPROVED

Last Update 03/30/2006

TRANSPORTATION ELECTRONIC AWARD & MANAGEMENT
ACTIVITY LINE ITEM CODE CHART
FOR RESEARCH AND OTHER EXPENDITURES

Non-Add Scope Codes
99X-nn

991-nn – Security Expenditures other than 5302(a)(1)(J) items
 992-nn – Tribal Projects
 993-nn ITS - Fleet Management
 994-nn ITS - Electronic Fare
 995-nn ITS - Traveler Information
 996-nn ADA / CAA Increased Federal Share
 (i.e. Alternate Federal Share matches such as 90/10 and 83/17)
 998-nn Transfer of Federal Equity
 999-nn Contingency Projects

TRANSP. ELECTRONIC AWARD & MANGMNT
ALTERNATIVE FUEL TYPE CODES
FOR BUS PURCHASES

BD - BIODIESEL
 BF - BUNKER FUEL
 BP - BATTERY-POWERED
 CN - COMPRESSED NATURAL GAS
 D1 - No. 1 GRADE DIESEL FUEL
 D2 - No. 2 GRADE DIESEL FUEL (Std.)
 DL - DIESEL LOW-SULFUR
 DM - DUAL MODE (DIESEL / ELEC)
 DP - DIESEL (PARTICULATE TRAP)
 EP - ELECTRIC TRACKLESS TROLLEY
 ET - ETHANOL
 FH - FUEL CELL, HYDROGEN FUEL
 FR - FUEL CELL, ON-BUS REFORMER
 GA - GASOLINE
 HE - HYBRID ELECTRIC - DIESEL
 HG - HYBRID ELECTRIC - NATURAL GAS
 HO - HYBRID ELECTRIC - OTHER
 LN - LIQUEFIED NATURAL GAS
 LP - LIQUEFIED PETROLEUM GAS
 MT - METHANOL
 OR - OTHER