

DISCLAIMER: The use of this standard is governed by the "Texas Engineering Practice Act". No warranty of any kind is made by TxDOT for any purpose whatsoever. TxDOT assumes no responsibility for the conversion of this standard to other formats or for incorrect results or damages resulting from its use.

DATE: FILE:

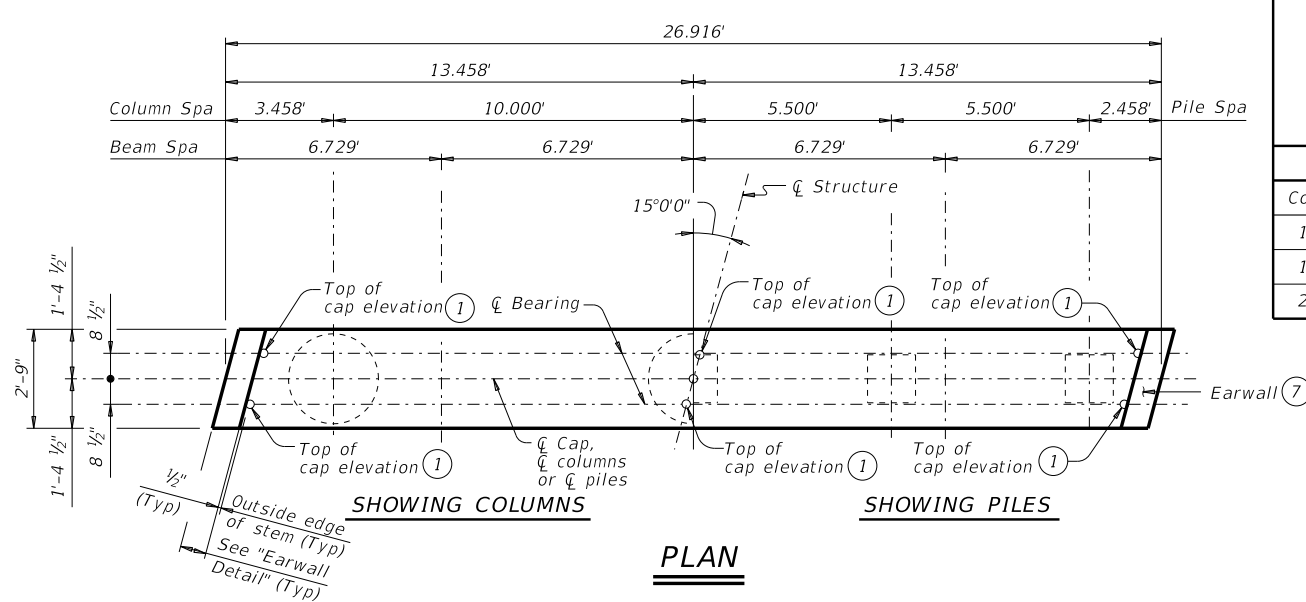

PLAN

TABLE OF MAXIMUM ALLOWABLE EXPOSED PILE HEIGHTS AND PILE LOADS (4)

Pile Type		Max Ht	Max Load
Concrete	Steel	Ft	Tons/Pile
16" Sq	HP14x73	16	75
18" Sq	HP14x117 (6)	20	90
20" Sq	HP18x135	24	110

FOUNDATION LOADS

Average SPAN Length	Drilled Shaft Loads (5)	Vertical Pile Loads
Ft	Tons/DS	Tons/Pile
30	73	38
35	80	42
40	87	46
45	94	50
50	101	54
55	108	58
60	114	62

TABLE OF ESTIMATED QUANTITIES FOR 3-COLUMN BENT (3)

Bar	No.	Size	Length	Weight
A	4	#11	26'-7"	565
B	4	#11	26'-7"	565
E	2	#5	2'-6"	5
F	16	#4	6'-2"	66
S	26	#5	11'-2"	303
T	4	#5	26'-7"	111
V	24	#9	32'-9"	2,672
Z	3	#3	391'-0"	441

Reinforcing Steel	Lb	4,728
Class "C" Concrete (Cap)	CY	8.3
Class "C" Concrete (Col)	CY	16.4

TABLE OF ESTIMATED QUANTITIES FOR 5-PILE BENT

Bar	No.	Size	Length	Weight
A	4	#11	26'-7"	565
B1	2	#11	26'-7"	282
B2	8	#11	4'-0"	170
E	2	#5	2'-6"	5
F	16	#4	6'-2"	66
S	28	#5	11'-2"	326
T	4	#5	26'-7"	111

Reinforcing Steel	Lb	1,525
Class "C" Concrete (Cap)	CY	8.3

- Top of cap elevations are based on section depths shown on Span Details.
- 1/2" preformed bituminous fiber material between beam stem and earwall. Bond to beam with an approved adhesive. Cast inside face of earwall with face of beam stem.
- Quantities shown are based on an "H" value of 30'. For each linear foot variation in "H" value, make the following adjustments:
 Bars V length ~ 1'-0"
 Bars Z length ~ 12'-7"
 Reinforcing Steel ~ 96 Lb
 CI "C" Conc (Column) ~ 0.55 CY
- This standard may not be used for "H" heights exceeding 30' or exposed pile heights exceeding the values shown in the table. In areas of very soft soil or where scour is anticipated, allowable "H" heights or exposed pile heights must be evaluated by the Engineer prior to the use of this standard.
- Foundation Loads based on "H" = 30'.
- When HP14x117 steel piling is specified in the plans, the Contractor has the option of furnishing either HP14x117 or HP16x101 steel piling.
- Do not cast earwalls until beams are erected in their final position.
- Surface finish top of cap with a textured wood float. Level surface in the direction of the centerline of beams. Provide bearing surface clean and free of all loose material before placing bearing pads.
- See FD standard.

MATERIAL NOTES:
 Provide Class C concrete (f'c = 3,600 psi).
 Provide Class C (HPC) concrete if shown elsewhere in the plans.
 Provide Grade 60 reinforcing steel.

GENERAL NOTES:
 Designed according to AASHTO LRFD Bridge Design Specifications.
 Bent selected must be based on the average span length rounded up to the next 5-foot increment.
 For pile bents supporting unequal spans, the shorter span cannot be less than 80 percent of the longer span.
 See Bridge Layout for beam type and foundation type, size and length.
 See Common Foundation Details (FD) standard sheet for all foundation details and notes. This standard does not support the use of multi-pile footings as shown on standard FD. Details are drawn showing right forward skew. See Bridge Layout for actual skew direction.
 These bent details may be used with standard SDSB-24-15 only.
 Cover dimensions are clear dimensions, unless noted otherwise.
 Reinforcing bar dimensions shown are out-to-out of bar.

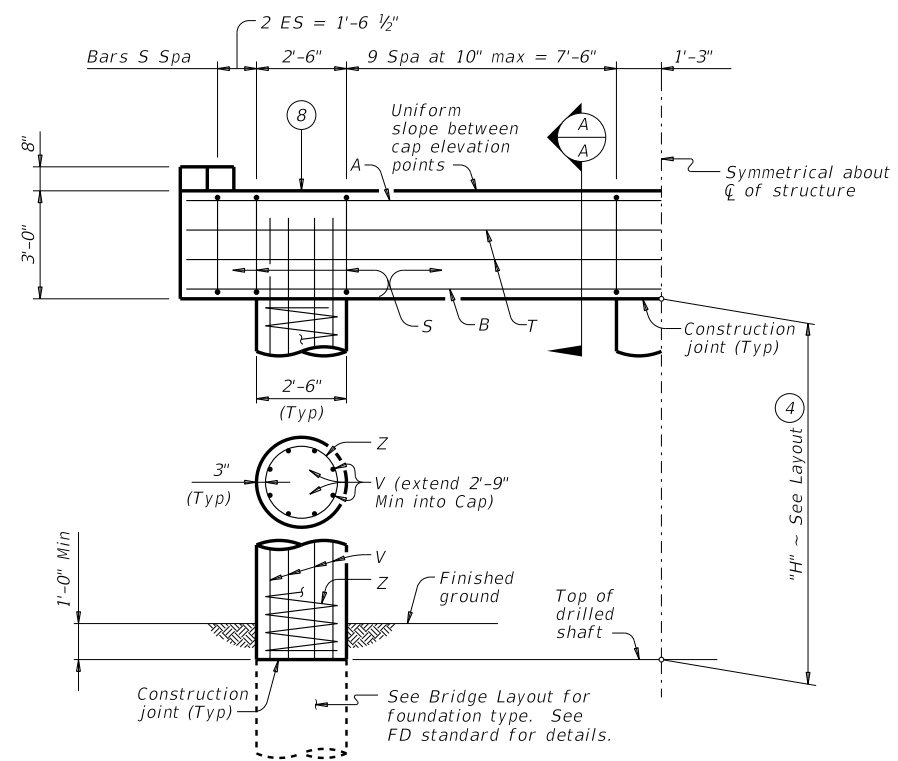

HALF ELEVATION ~ 3 COLUMN BENT

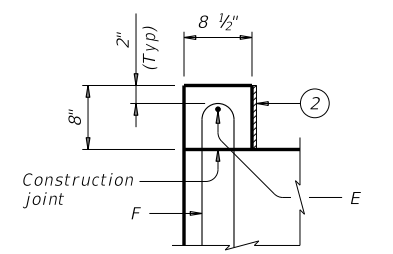

ELEVATION EARWALL DETAIL (7)

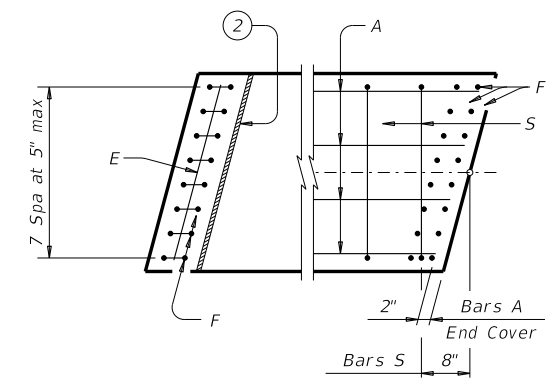

EARWALL CAP END DETAIL

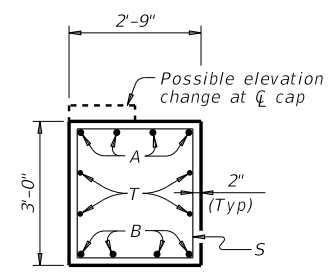

SECTION A-A

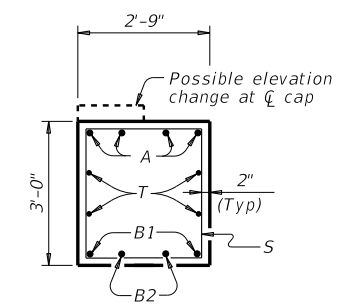

SECTION B-B

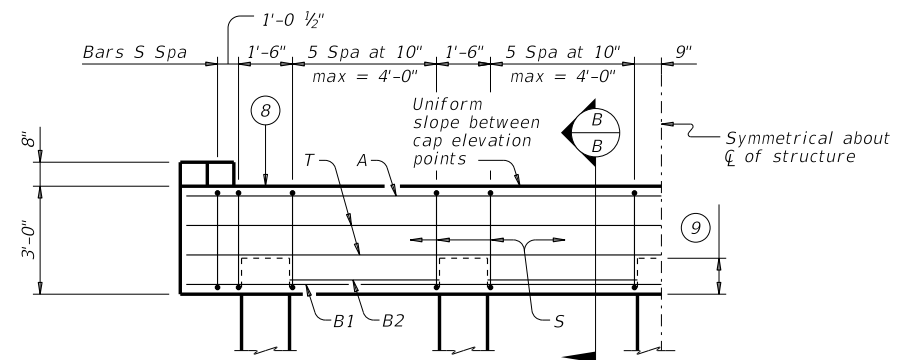

HALF ELEVATION ~ 5 PILE BENT

(Showing 16" piles ~ for piles larger than 16", adjust Bars S spacing as required to avoid piles)

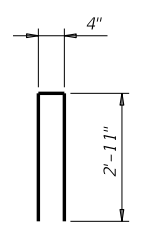

BARS F

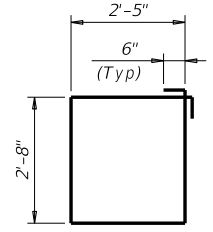

BARS S

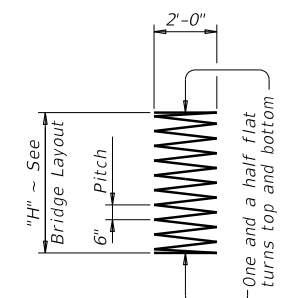

BARS Z

HL93 LOADING

Texas Department of Transportation Bridge Division Standard

**INTERIOR BENTS
 PRESTRESSED CONCRETE
 DECKED SLAB BEAMS
 24' ROADWAY 15° SKEW**

BDSB-24-15

FILE: dsbste10-20.dgn	DN: JLR	CK: SDC	DW: TxDOT	CK: TAR
©TxDOT August 2020	CONT	SECT	JOB	HIGHWAY
REVISIONS	DIST	COUNTY	SHEET NO.	