

DISCLAIMER: This standard is governed by the "Texas Engineering Practice Act". No warranty of any kind is made by TxDOT for any purpose whatsoever. TxDOT assumes no responsibility for the conversion of this standard to other formats or for incorrect results or damages resulting from its use.

**TABLE OF ESTIMATED QUANTITIES CS-80-28 (30°)**

Bar	No.	Size	Length	Weight
A1 (6)	34	# 8	85'-10"	7,792
A2	58	# 8	12'-0"	1,858
B (7)	62	# 8	83'-9"	13,864
D	133	# 4	29'-9"	2,643
D1-30	60	# 4	15'-8"AV	628
G1	8	# 5	31'-2"	260
G2	16	# 5	4'-0"	67
T	67	# 4	29'-9"	1,331
T1-15	30	# 4	15'-2"AV	304

Reinforcing Steel	Lb	28,747
Class "S" Concrete (9)	CY	121.0

- (6) Length shown includes one 4'-8" lap splice.
- (7) Length shown includes one 2'-7" lap splice.
- (8) See standard CS-MD for Expansion Joint Details.
- (9) Provide Class S (HPC) if shown elsewhere in the plans.

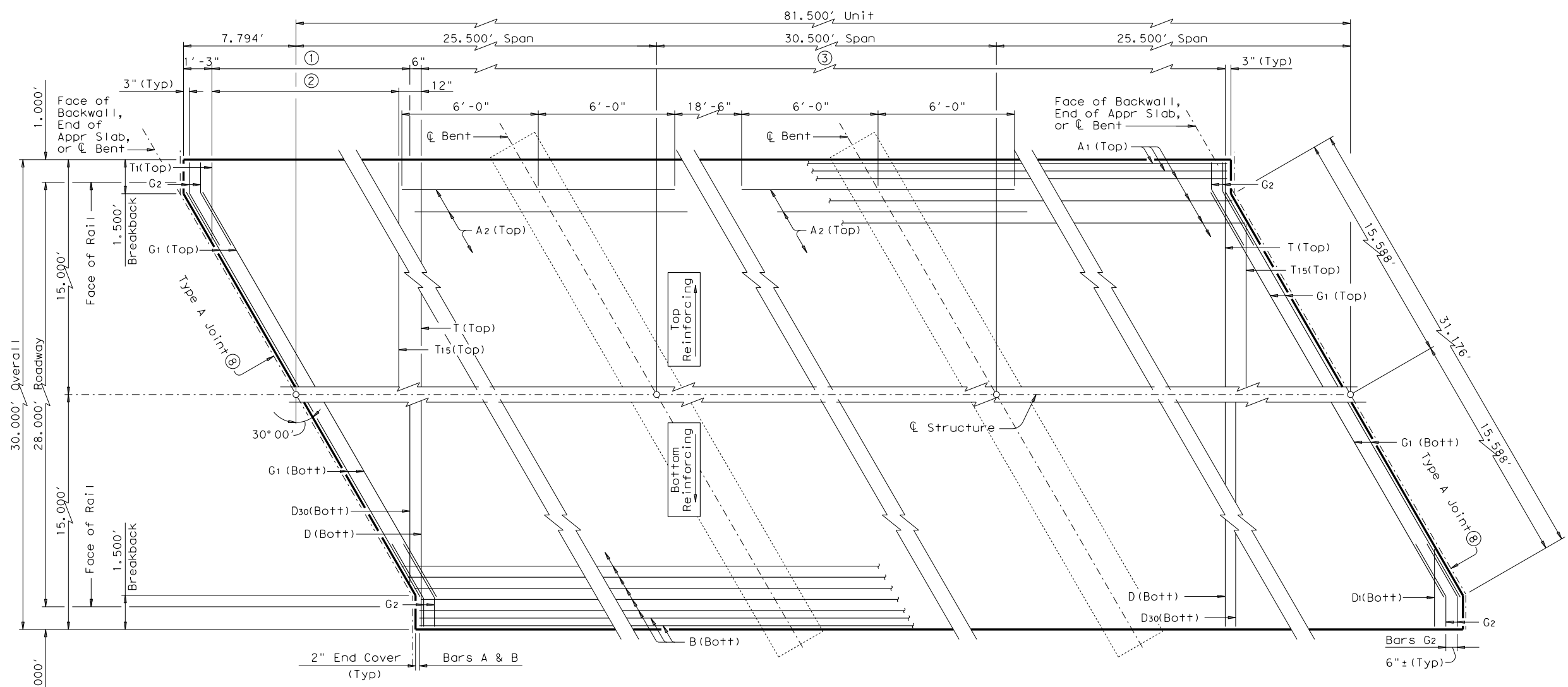

- ① Bars D1-30 (Bott) at 6" Max Spacing = 14'-1 1/4"
- ② Bars T1-15 (Top) at 12" Max Spacing = 13'-7 1/4"
- ③ Bars D (Bott) at 6" Max Spacing  
Bars T (Top) at 12" Max Spacing

**PLAN**

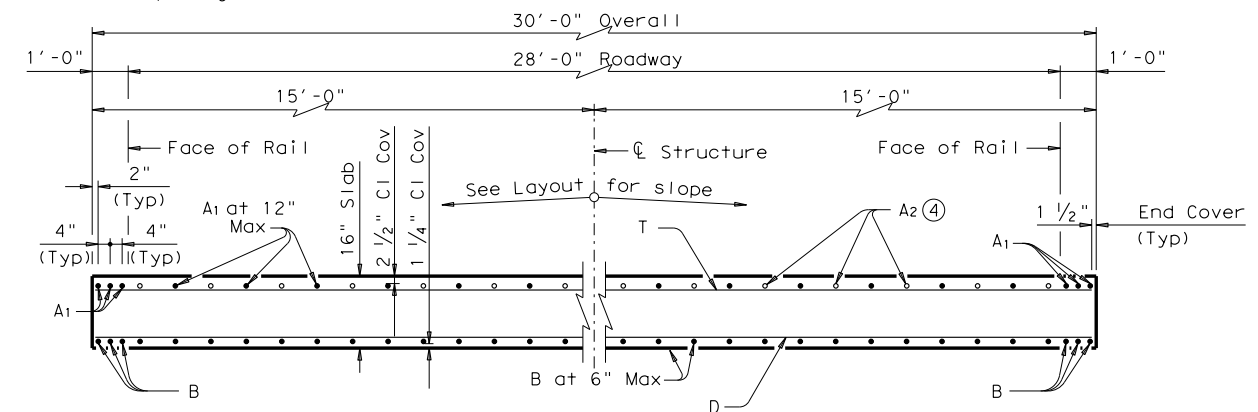

**TYPICAL TRANSVERSE SECTION**

- ④ Place Bars A2 between Bars A1 over Bent (See PLAN for Placement)

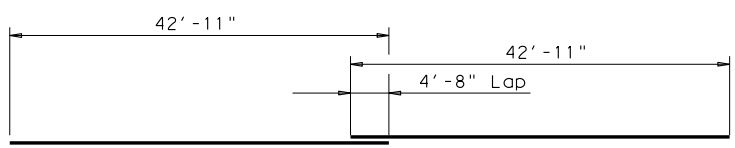

**BARS A1**

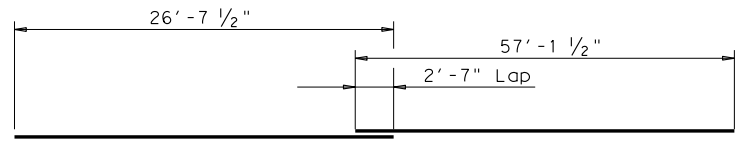

**BARS B (5)**

- ⑤ Alternate Splices over Supports

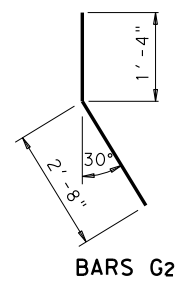

**BARS G2**

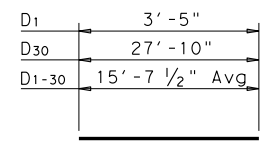

**BARS D**

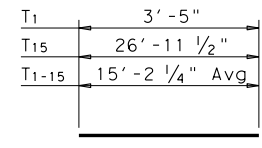

**BARS T**

**GENERAL NOTES:**  
 Designed according to AASHTO LRFD Specifications.  
 Details shown are for right forward skew. See Layout for actual skew direction. See standard CS-MD for additional slab span details.  
 All reinforcing shall be Grade 60. Concrete strength  $f'c = 4,000$  psi. When epoxy coated reinforcing is used, the lap splice lengths shown shall be increased by a factor of 1.5. This standard does not support the use of Transition Bents.

HL93 LOADING



**81.5' C-I-P CONTINUOUS SLAB UNIT**  
 (25.5'-30.5'-25.5')  
 28 FT ROADWAY 30° SKEW  
**CS-80-28-30**

FILE: scs41ste.dgn	DN: TxDOT	CK: TxDOT	DW: TxDOT	CK: TxDOT
©TxDOT March 2009	CONT	SECT	JOB	HIGHWAY
REVISIONS				
	DIST	COUNTY		SHEET NO.

DATE:  
FILE: