

SECTION 11

2012 EDITION - REVISION 4

Standard Highway Sign Designs for Texas

Symbols and Arrows



**Drawings may not be drawn to scale.
Do not photocopy for manufacturing.**

May 2021

(This page left intentionally blank)

STANDARD ARROW DETAILS

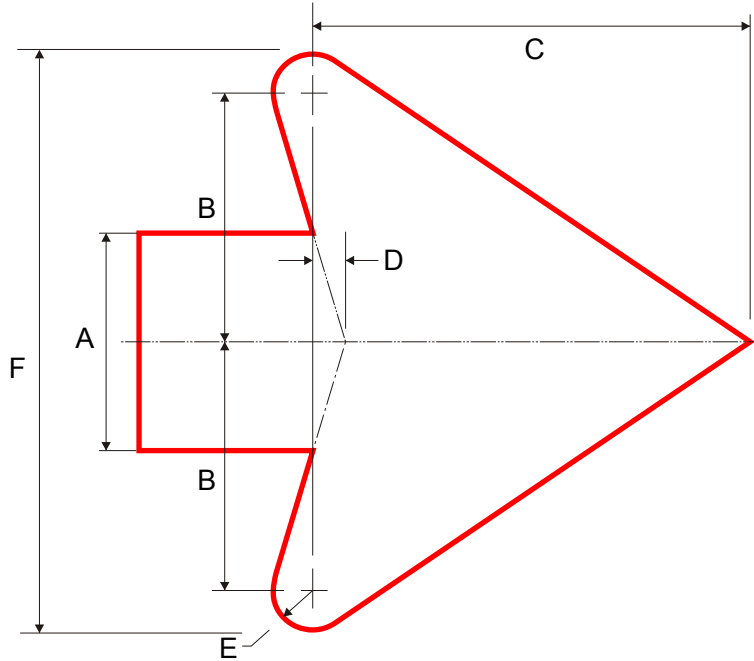

A	B	C	D	E	F
.28	.322	.568	.04	.056	0.756
.55	.638	1.13	.08	.111	1.500
.64	.746	1.28	.106	.128	1.750
.68	.78	1.38	.105	.136	1.832
.75	.875	1.5	.125	.15	2.05
1.125	1.3	2.284	.175	.225	3.05
1.375	1.58	2.8	.213	.275	3.71
1.5	1.75	3.063	.25	.313	4.126
1.6	1.8	3.188	.25	.313	4.226
1.625	1.875	3.313	.25	.313	4.376
1.75	2	3.55	.27	.35	4.7
2	2.313	4.313	.313	.375	5.376
2.25	2.625	4.5	.375	.438	6.126
2.5	2.875	5.063	.375	.5	6.75
2.625	3	5.25	.375	.5	7
2.75	3	5.563	.438	.563	7.126
3	3.5	6.125	.438	.563	8.126
3.125	3.625	6.375	.5	.625	8.5
3.25	3.75	6.625	.5	.625	8.75
3.313	3.813	6.688	.5	.688	9.122
3.375	3.875	6.75	.5	.688	9.126
3.5	4	7.125	.563	.688	9.376
3.625	4.168	7.358	.563	.72	9.776
3.75	4.313	7.625	.563	.75	10.126

A	B	C	D	E	F
3.875	4.457	7.879	.581	.775	10.46
4	4.625	8.125	.625	.813	10.876
4.063	4.75	8.25	.625	.813	11.126
4.125	4.75	8.37	.625	.813	11.126
4.25	4.875	8.625	.625	.813	11.376
4.375	5	8.875	.688	.875	11.75
4.5	5.188	9.125	.688	.875	12.126
4.75	5.438	9.625	.75	1	12.876
4.875	5.625	9.875	.75	1	13.25
5	5.75	10.125	.75	1	13.5
5.25	6	10.625	.813	1.063	14.126
5.375	6.125	10.813	.813	1.1	14.45
5.5	6.375	11.125	.875	1.125	15
5.75	6.625	11.688	.875	1.125	15.5
6	6.875	12.188	.938	1.188	16.126
6.5	7.5	13.188	1	1.625	18.25
7	8	14.188	1.063	1.375	18.75
7.5	8.625	15.188	1.125	1.5	20.25
8	9.188	16.25	1.25	1.625	21.626
8.25	9.5	16.75	1.28	1.65	22.3
8.5	9.75	17.25	1.313	1.75	23
8.75	10	17.75	1.375	1.75	23.5
9	10.35	18.25	1.395	1.8	24.3
10	11.5	20.3	1.563	2	27

TYPE "A", TYPE "B" AND DOWN (UP) ARROWS

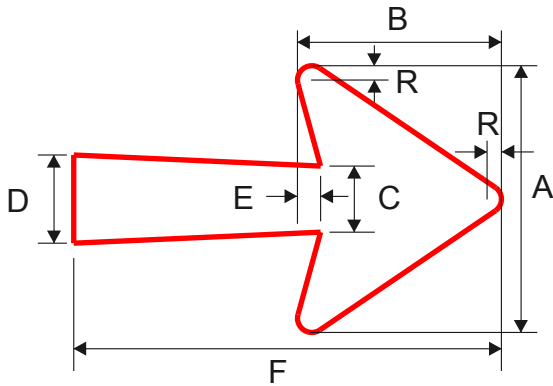

TYPE "A"

	A	B	C	D	E	F	R
A-1	15.125	11.5625	3.75	5	1.3125	24.25	.8125
A-2	18.25	14	4.5	6	1.5	29.25	.75
A-3	22.25	17	5.375	7.125	1.75	35.625	1

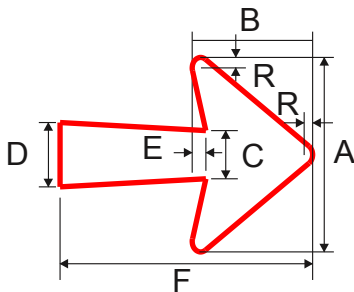

TYPE "B"

	A	B	C	D	E	F	R
B-1	14.25	9.8125	3.375	4.5	1.3125	17.25	.75
B-2	17.5	11.75	4.375	5.625	1.5	20.25	.875
B-3	21.875	14.25	5	6.75	1.75	25	1
B-4	8.4375	5.4375	2.3125	2.9375	.625	9.5625	.5

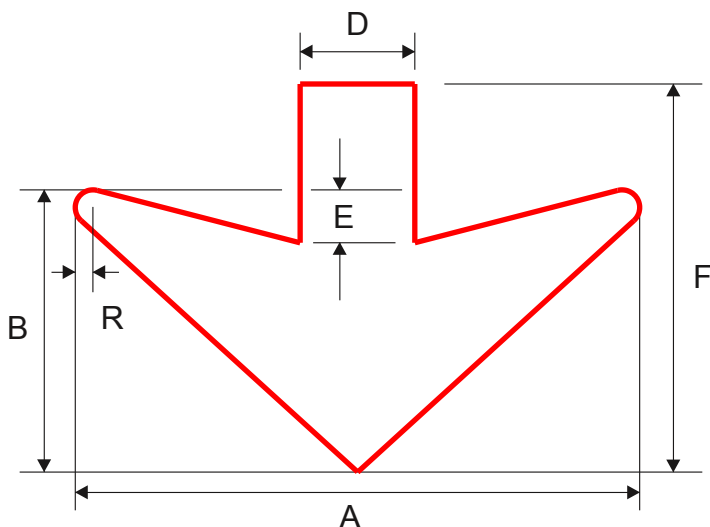

DOWN and/or UP ARROW

A	B	D	E	F	R
32	16	6.5	3	22	1
29	14.5	scale	scale	20	scale
23.25	11.625	scale	scale	16	scale
20.25	11.25	6.5	1.375	13.5	.75
14	7	4.5	.875	9.75	.5
15.25	8.5	5	scale	10.25	scale

ARROW DETAILS FOR E5-1aT and E5-1bT

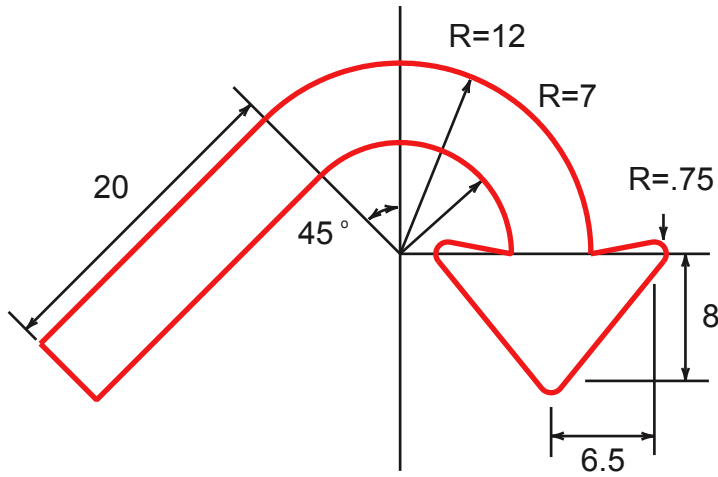

E-3

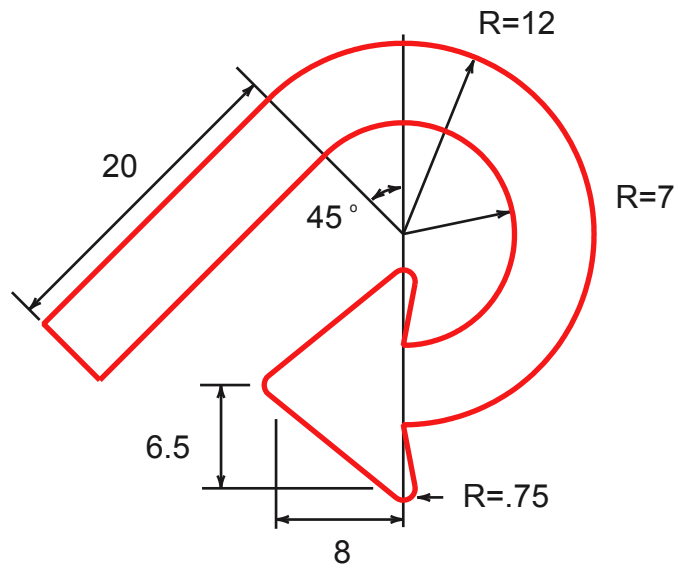

E-4

TEXAS

ROUNDBOUT ARROW DETAIL

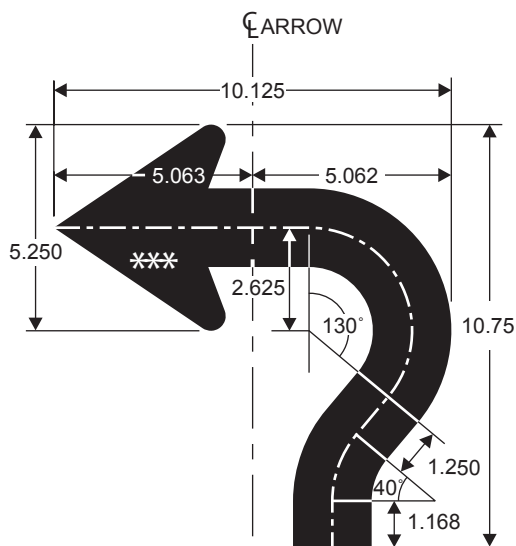

Signs - D1-1, D1-2, D1-3 and D3-2,

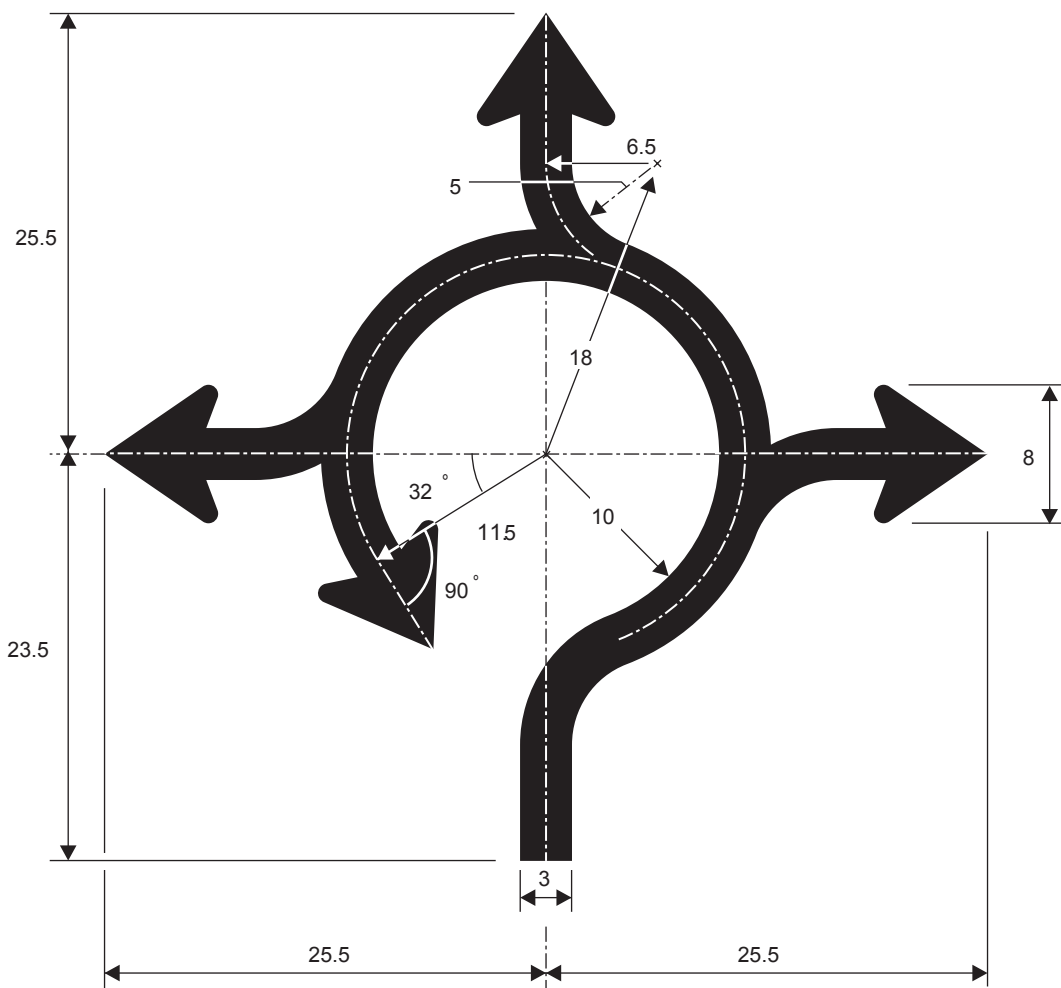

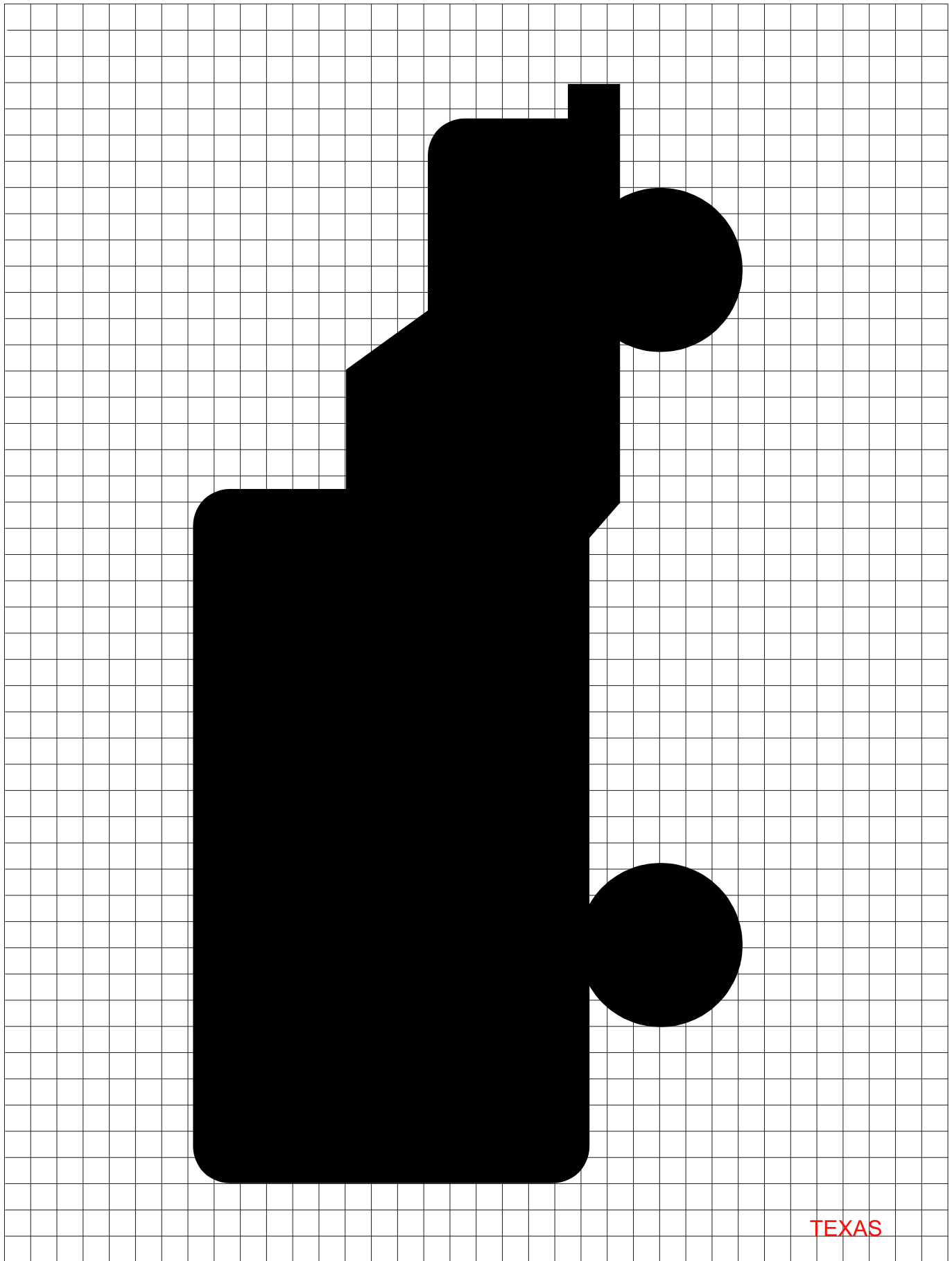

TEXAS

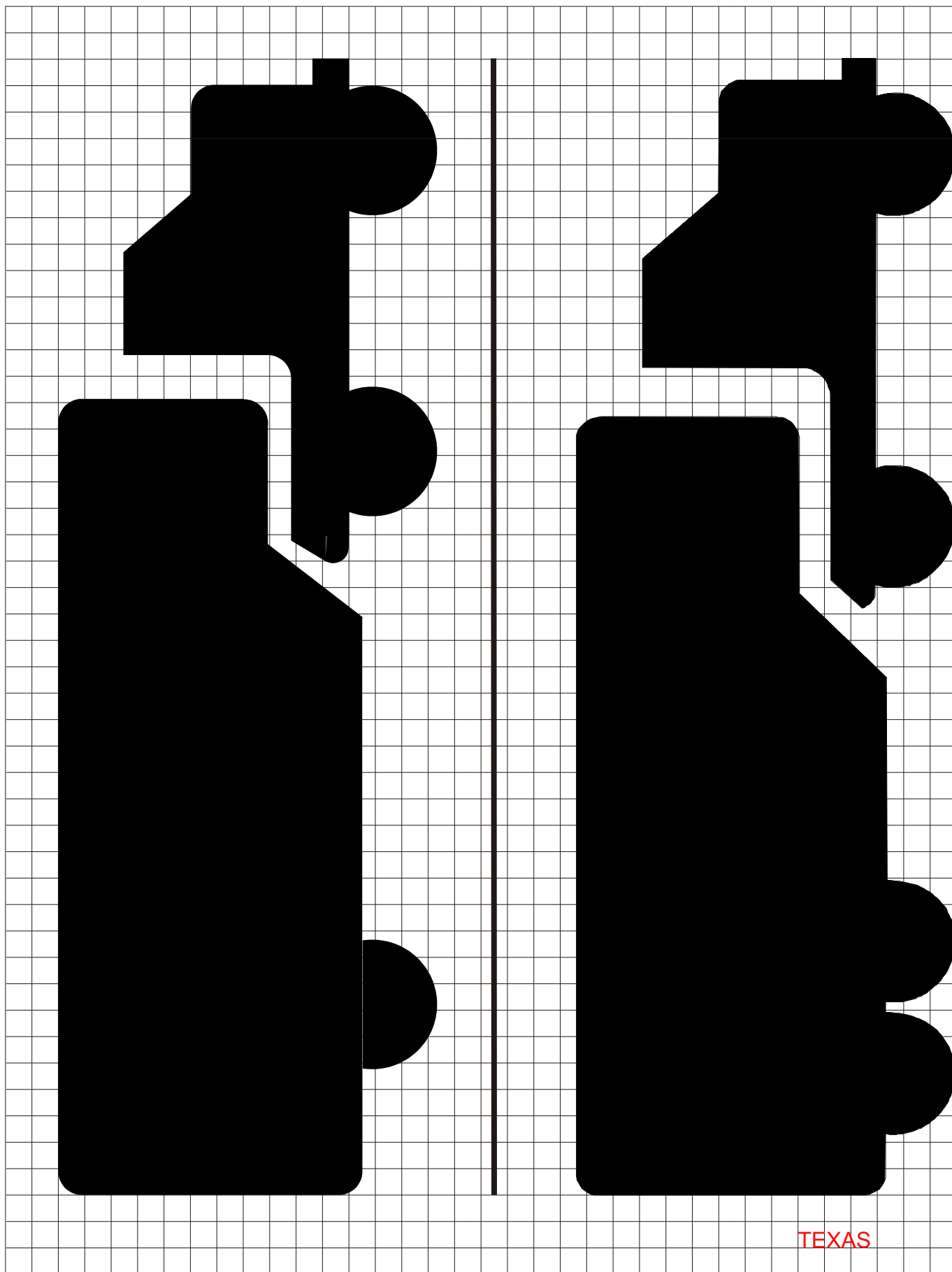

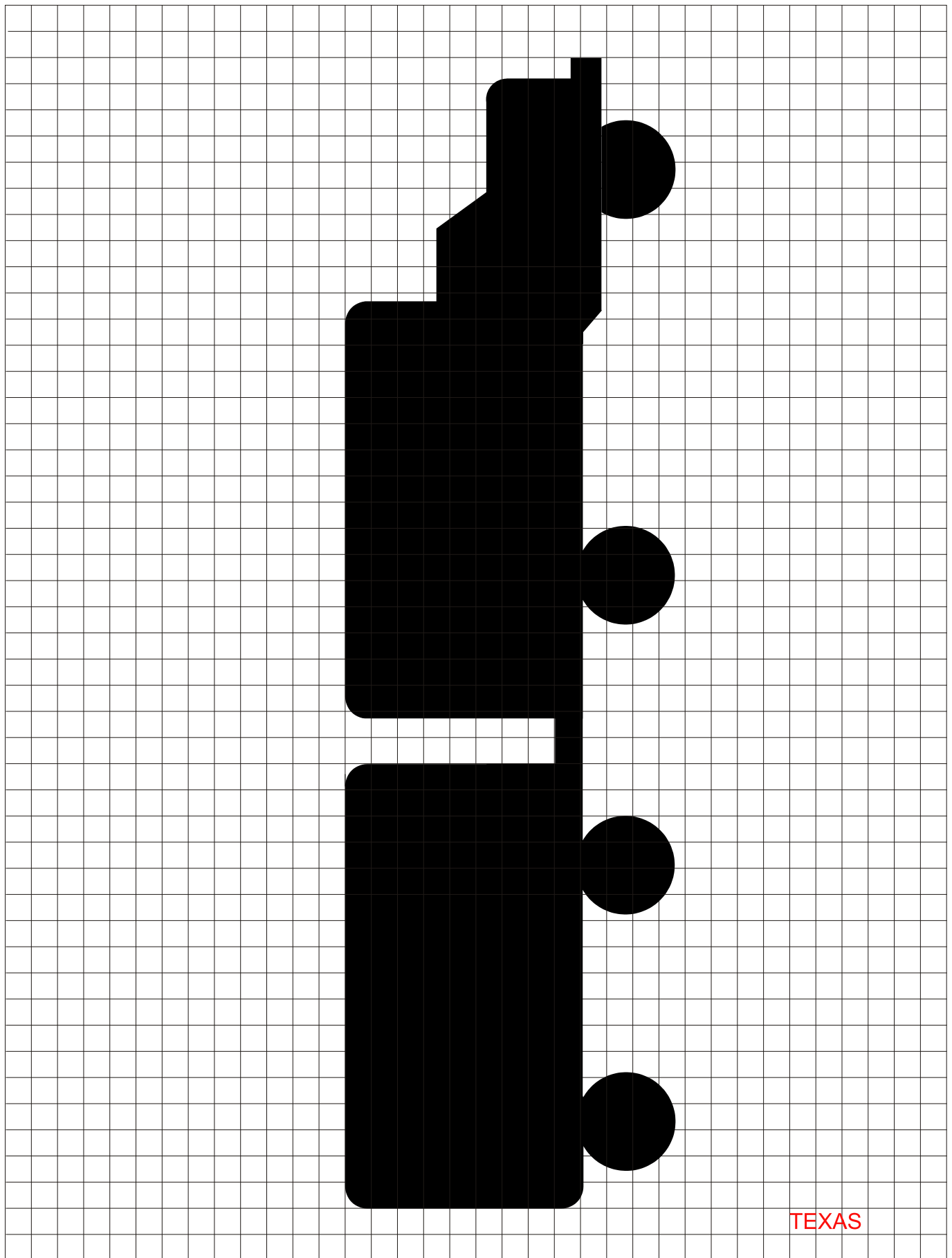

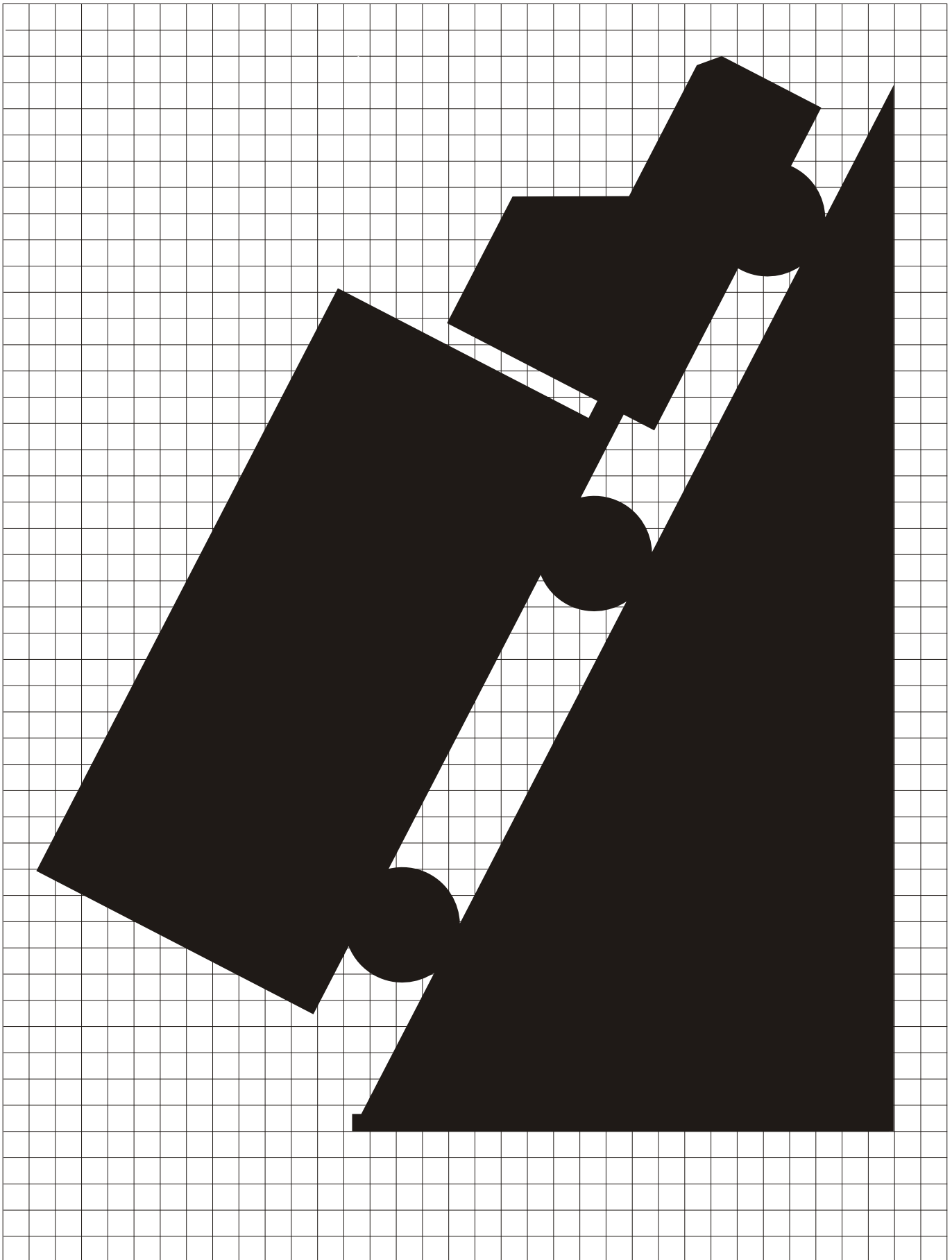

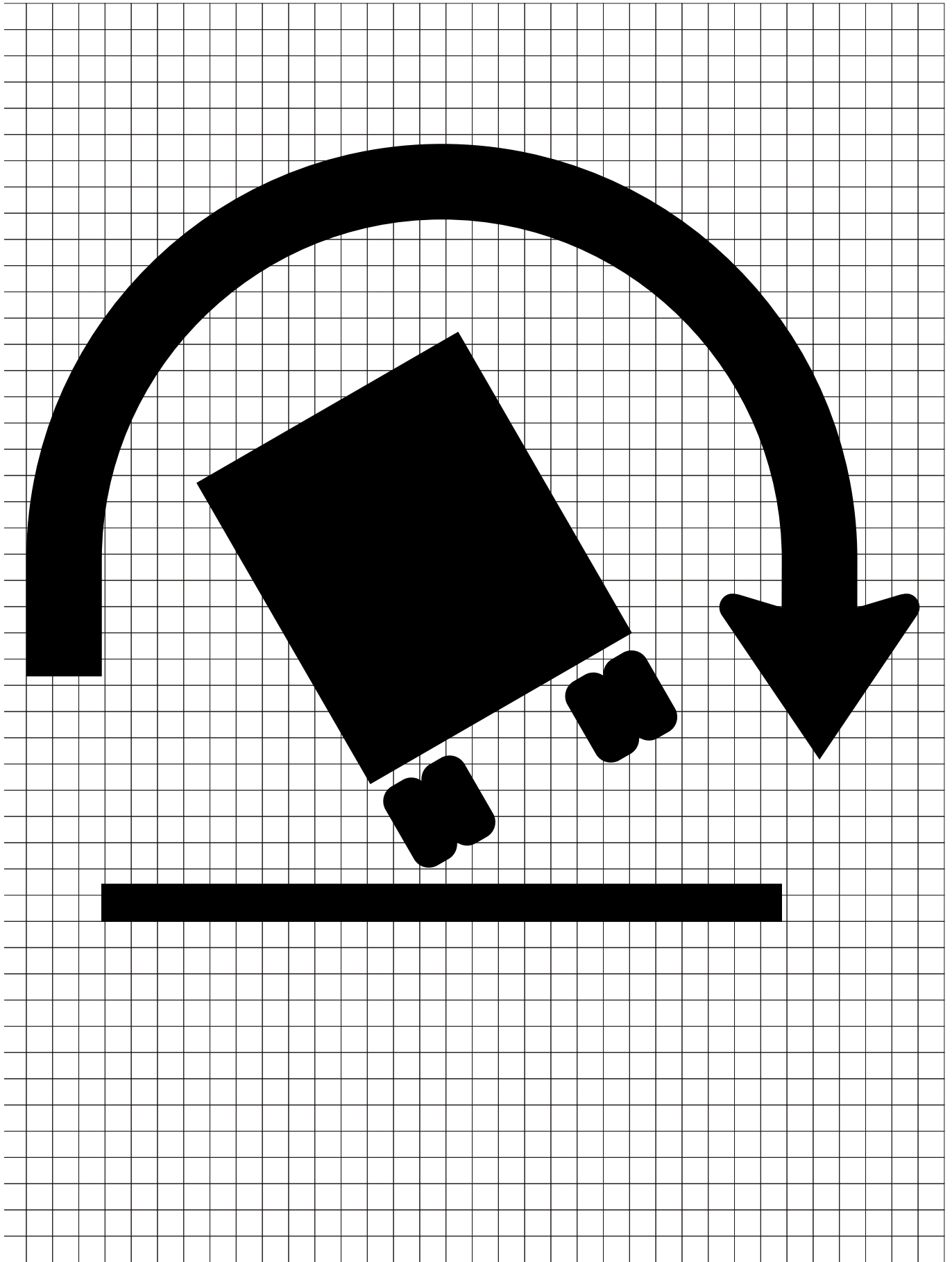

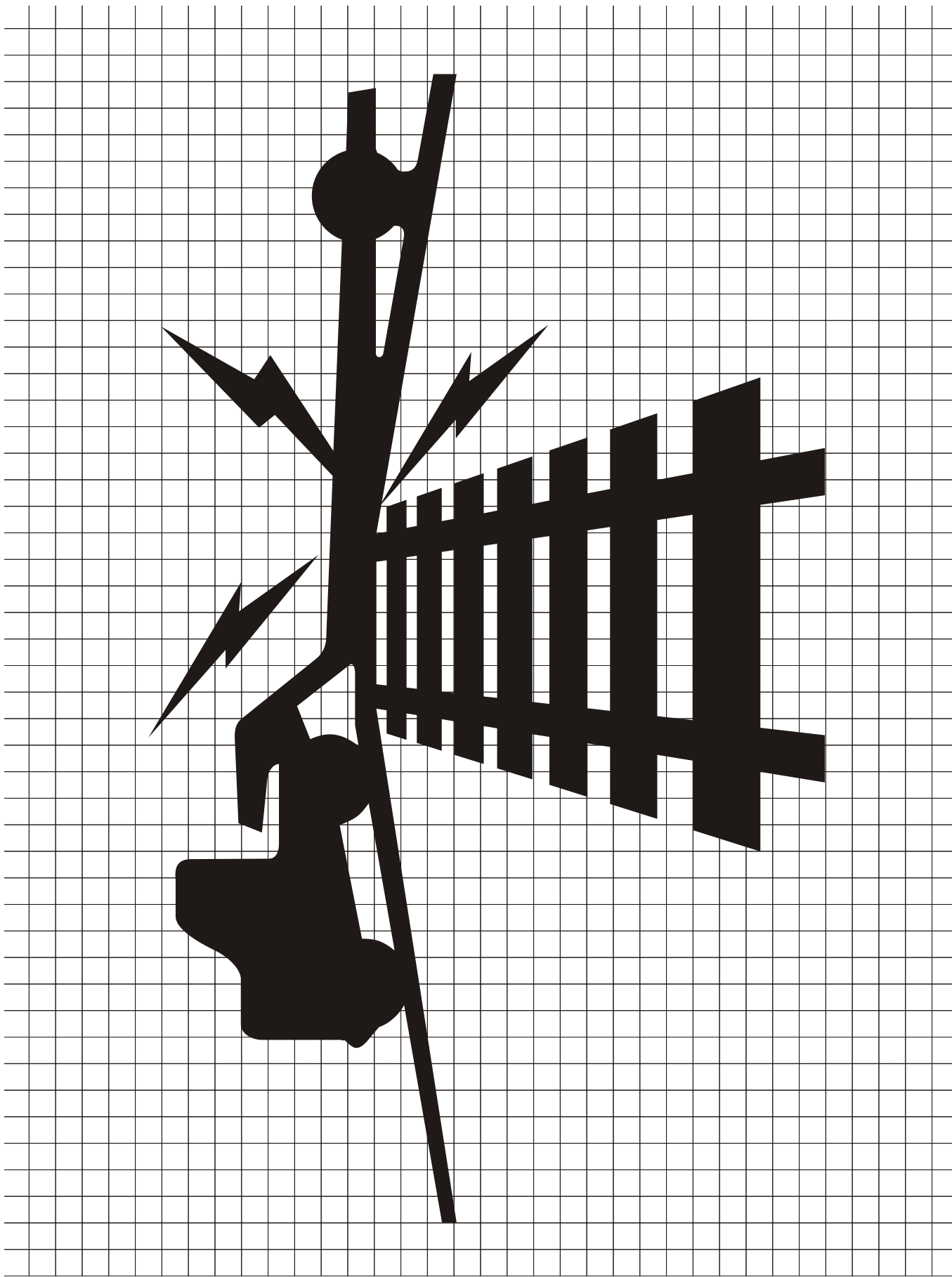

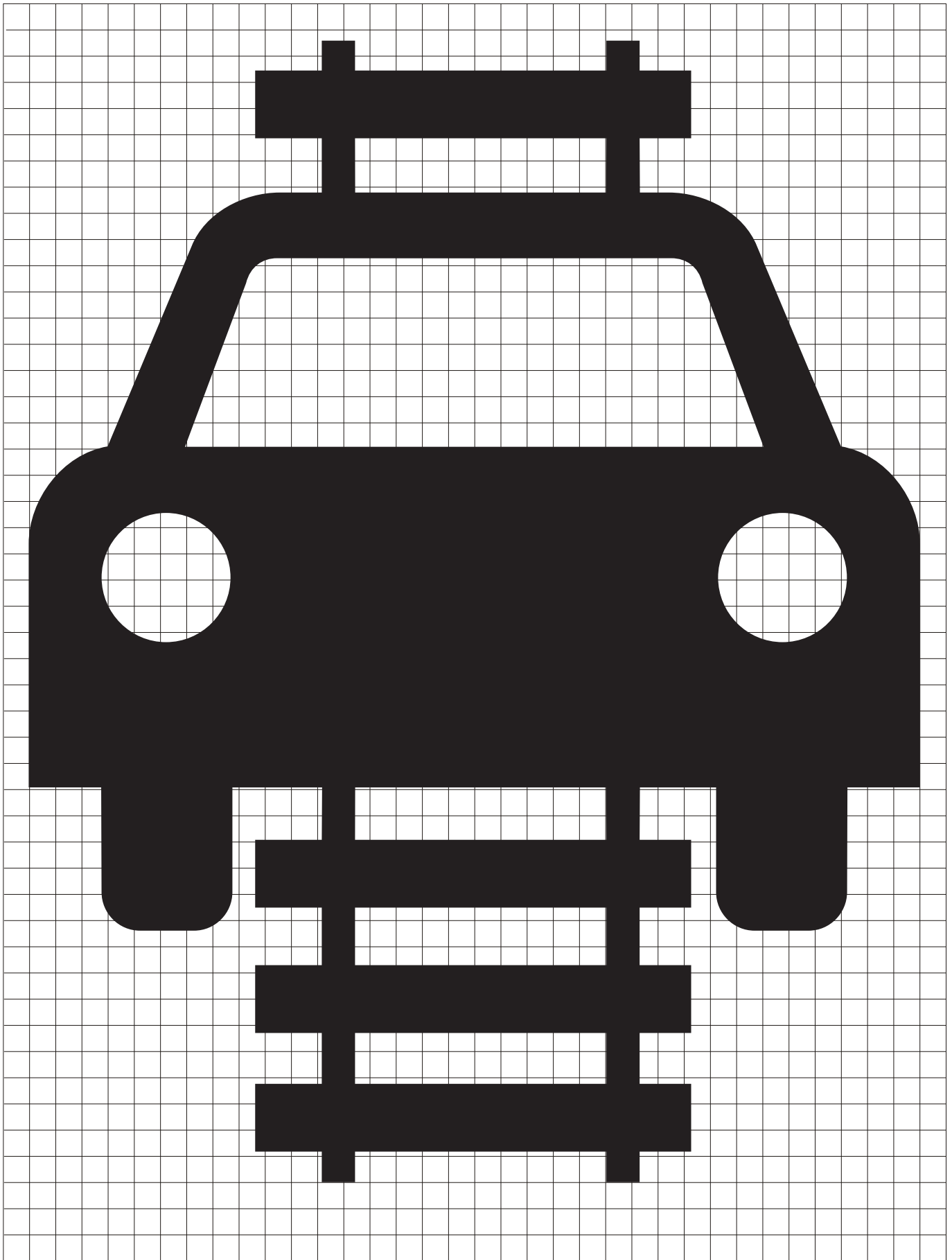

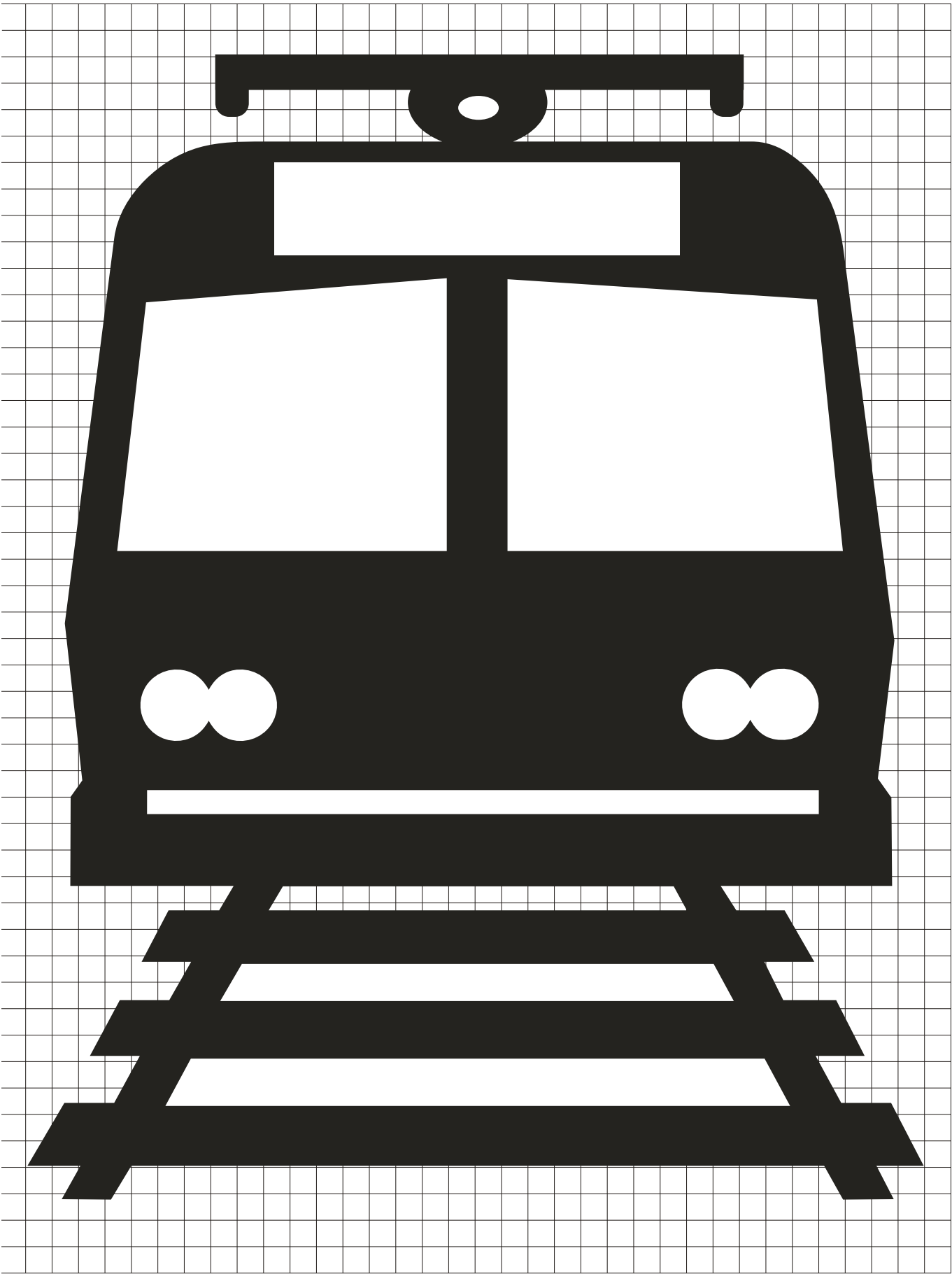

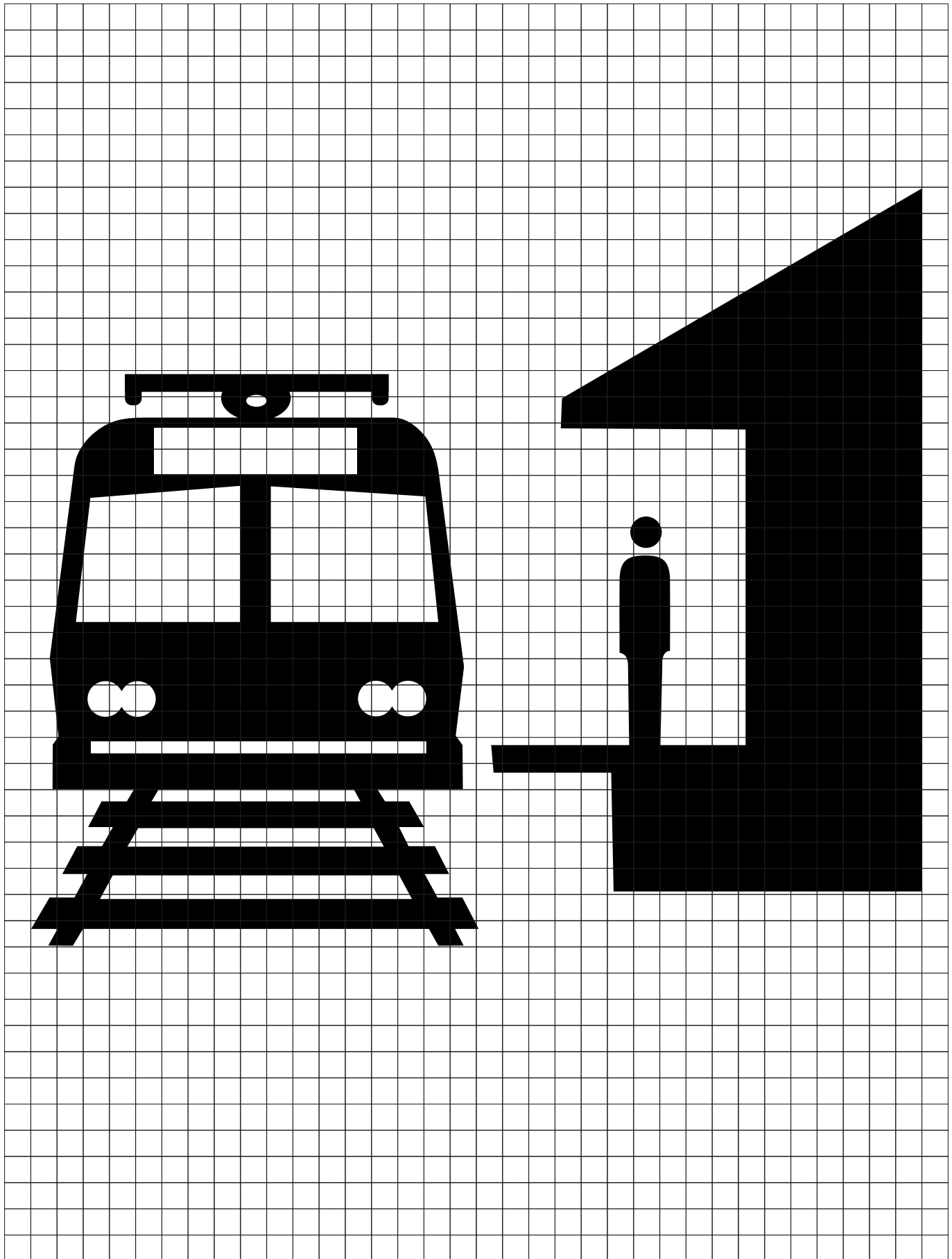

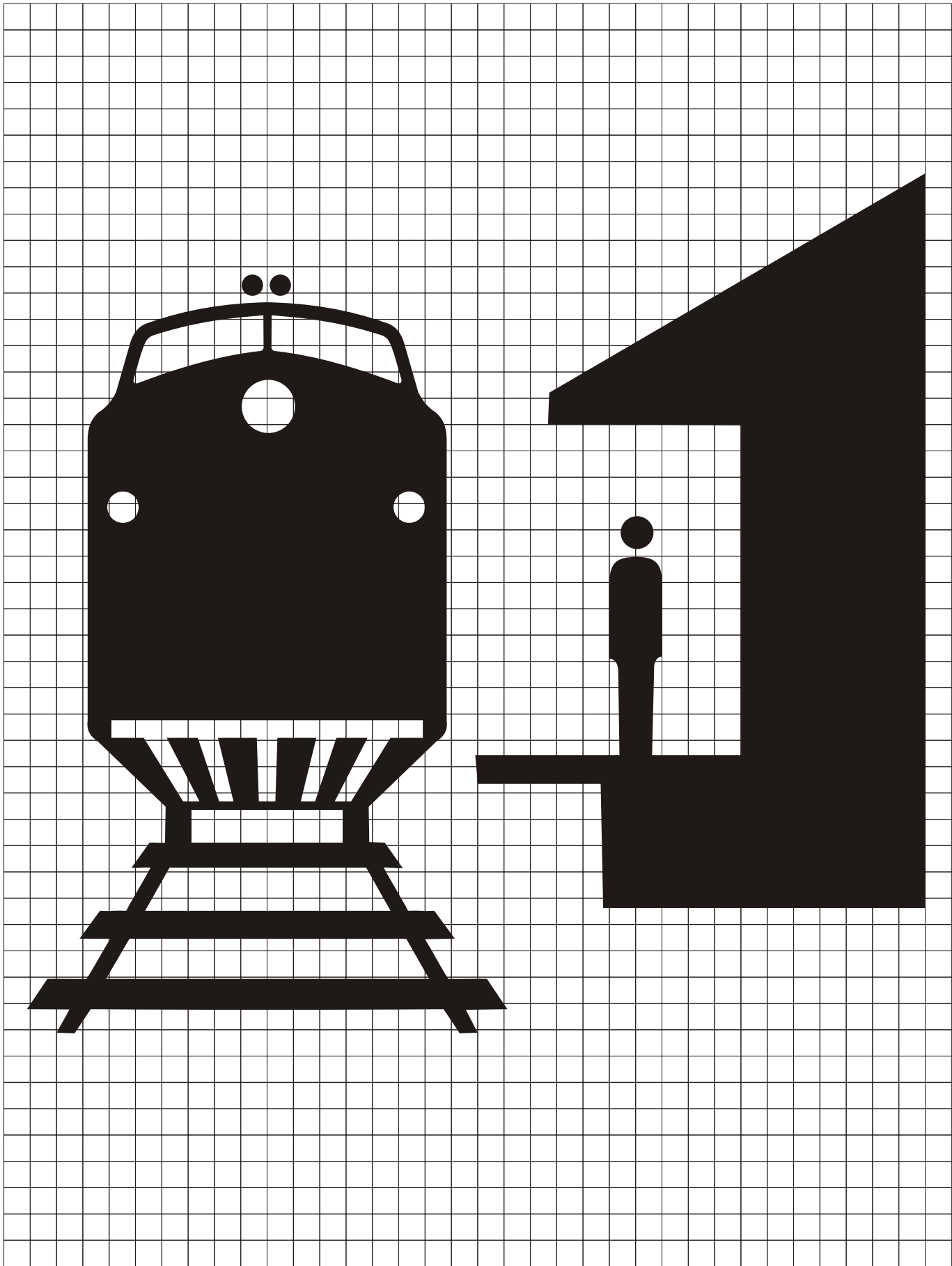

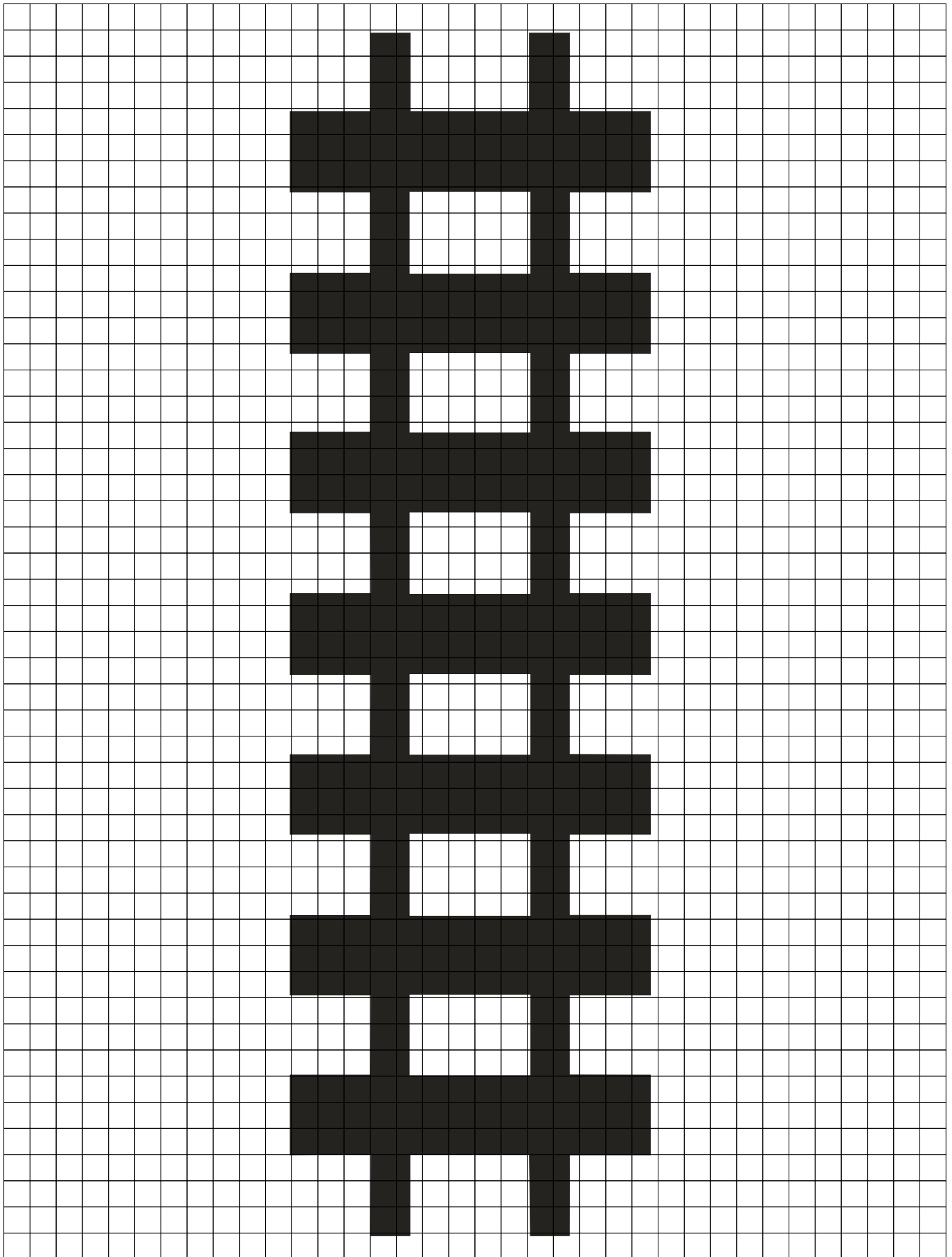

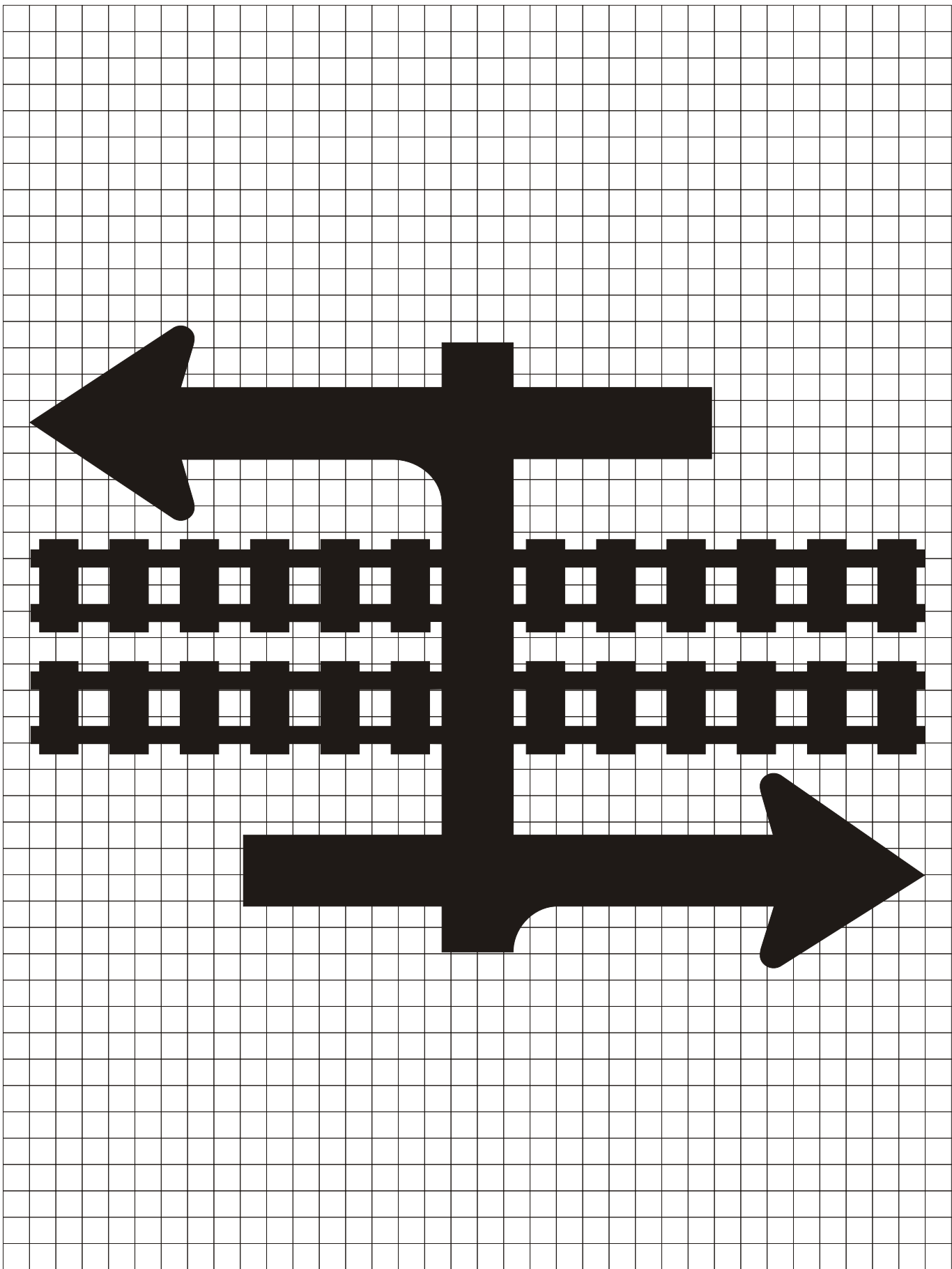

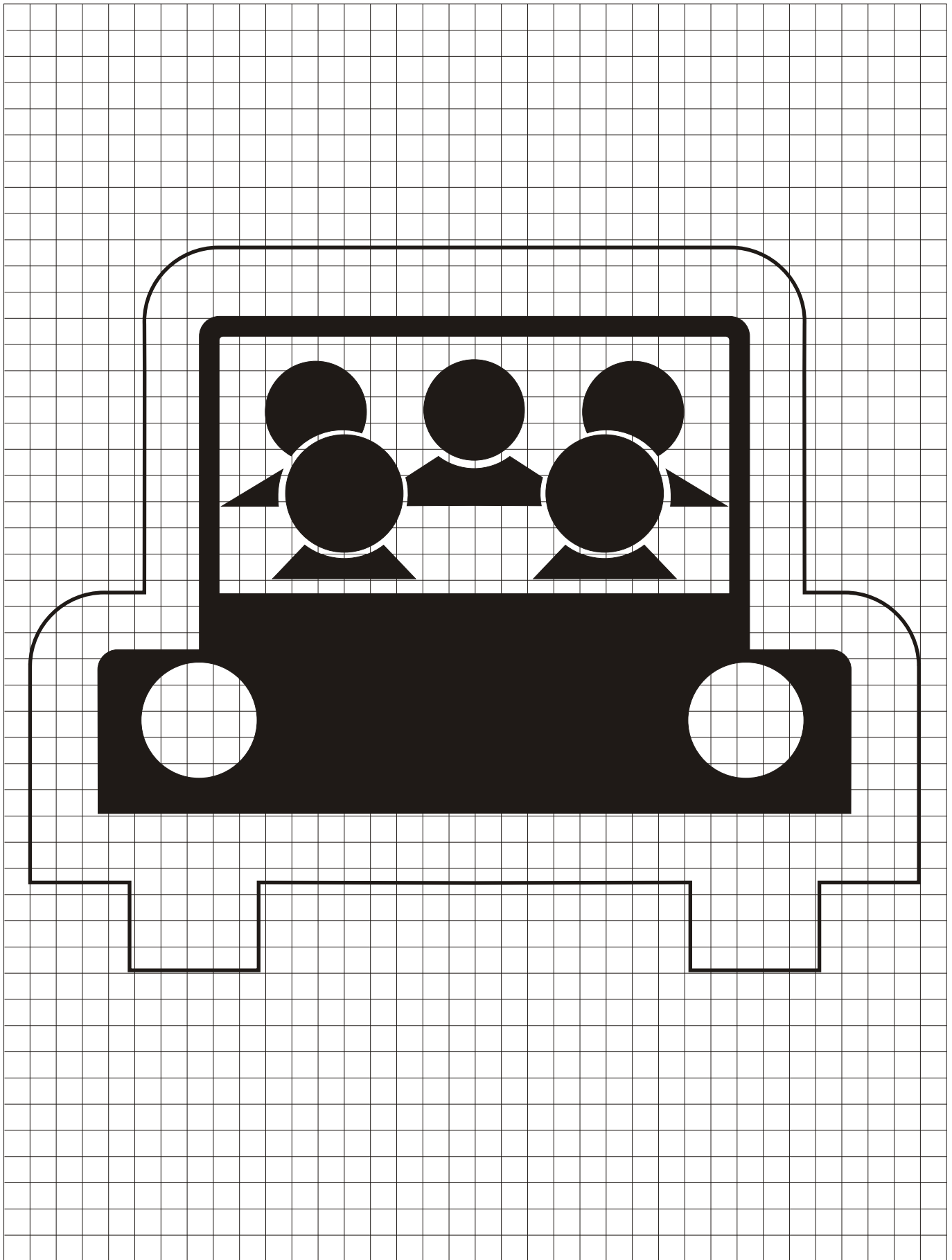

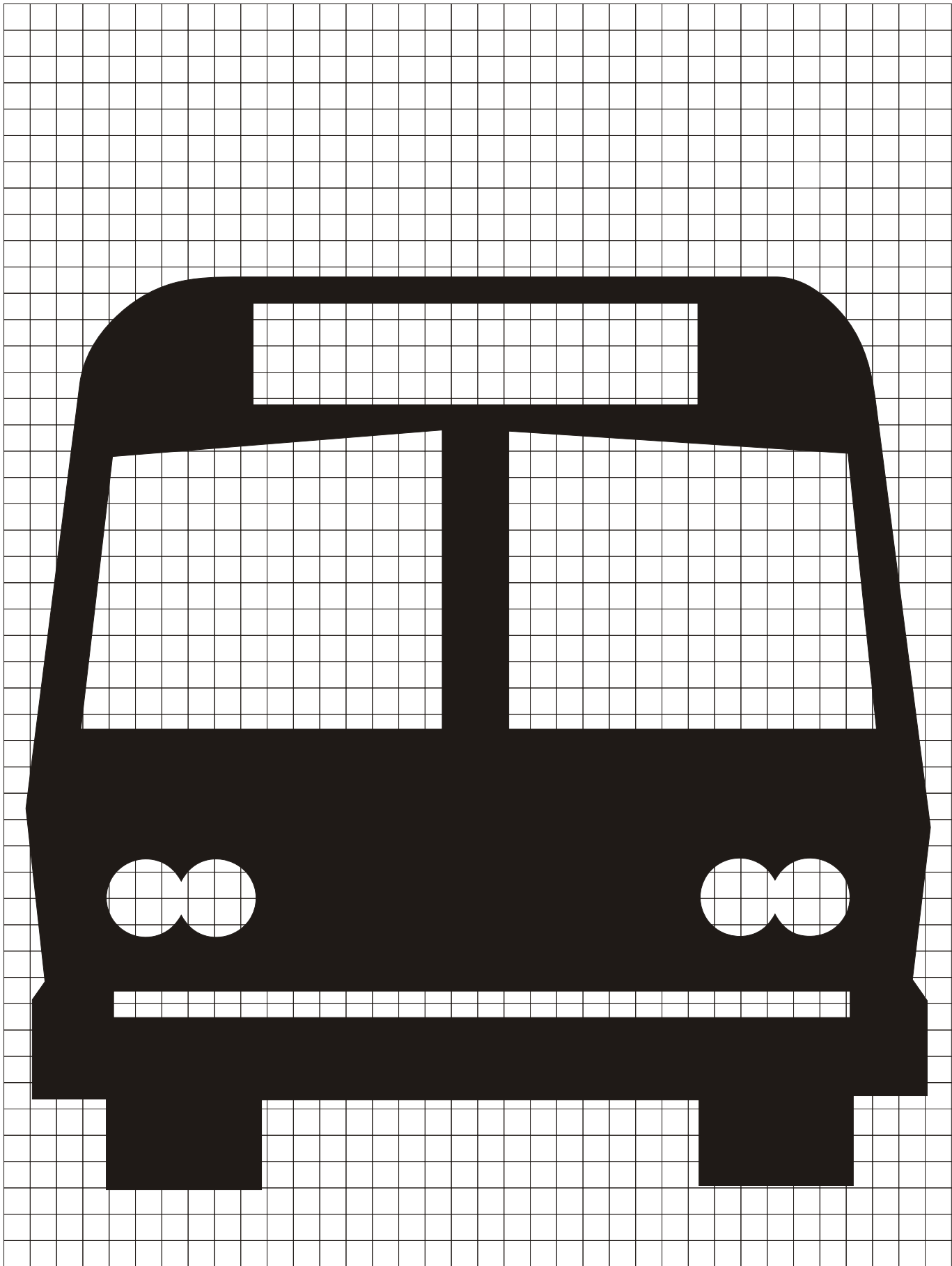

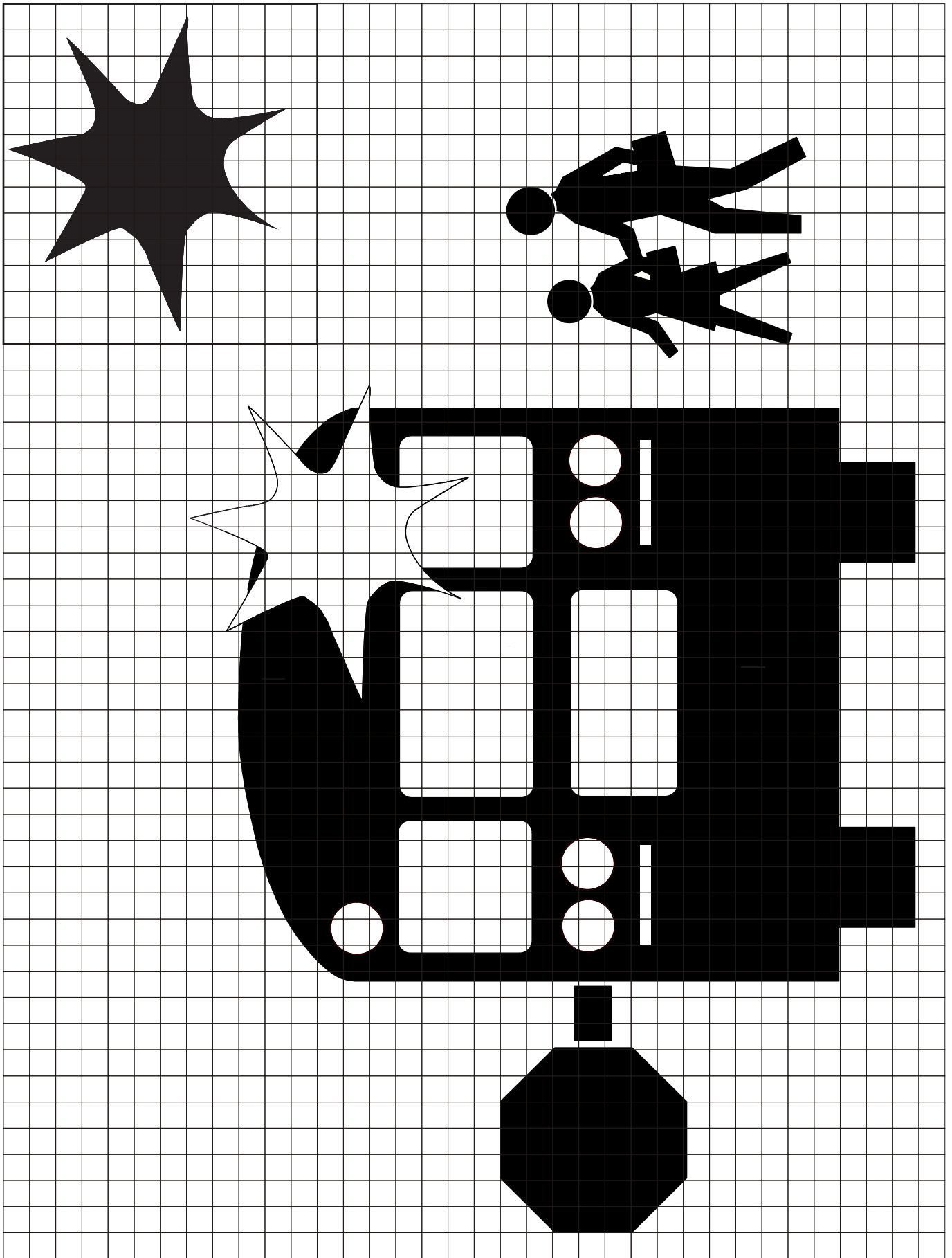

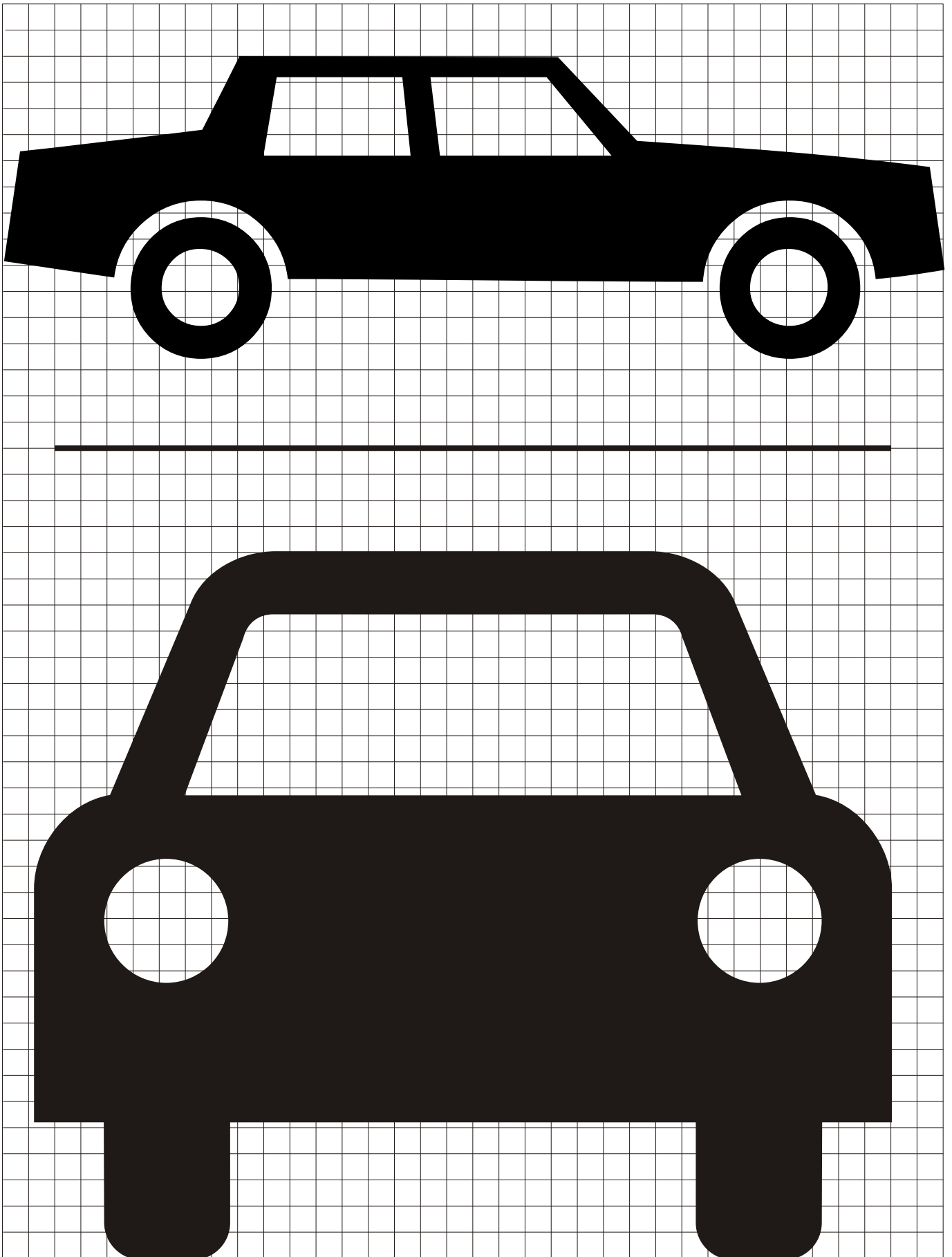

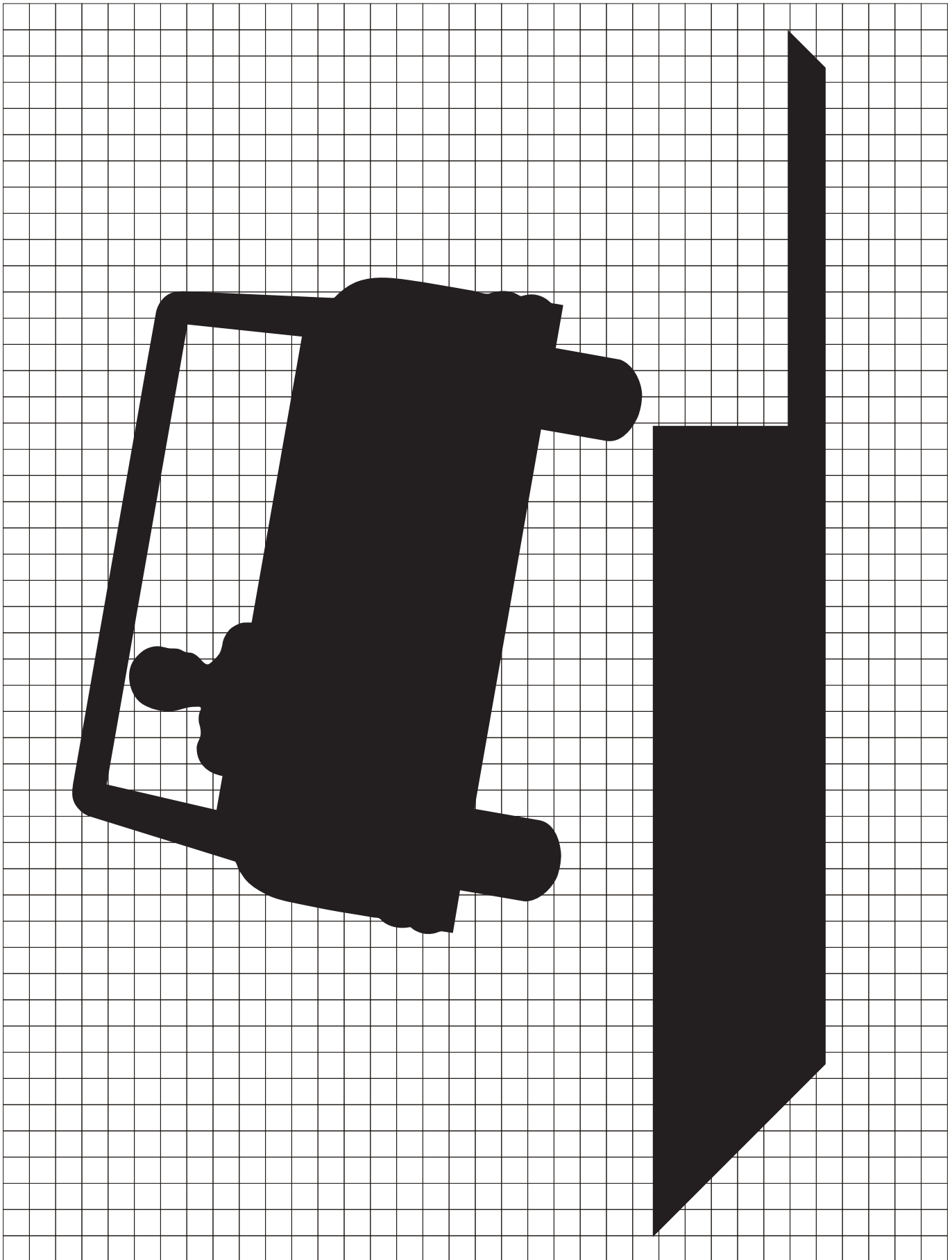

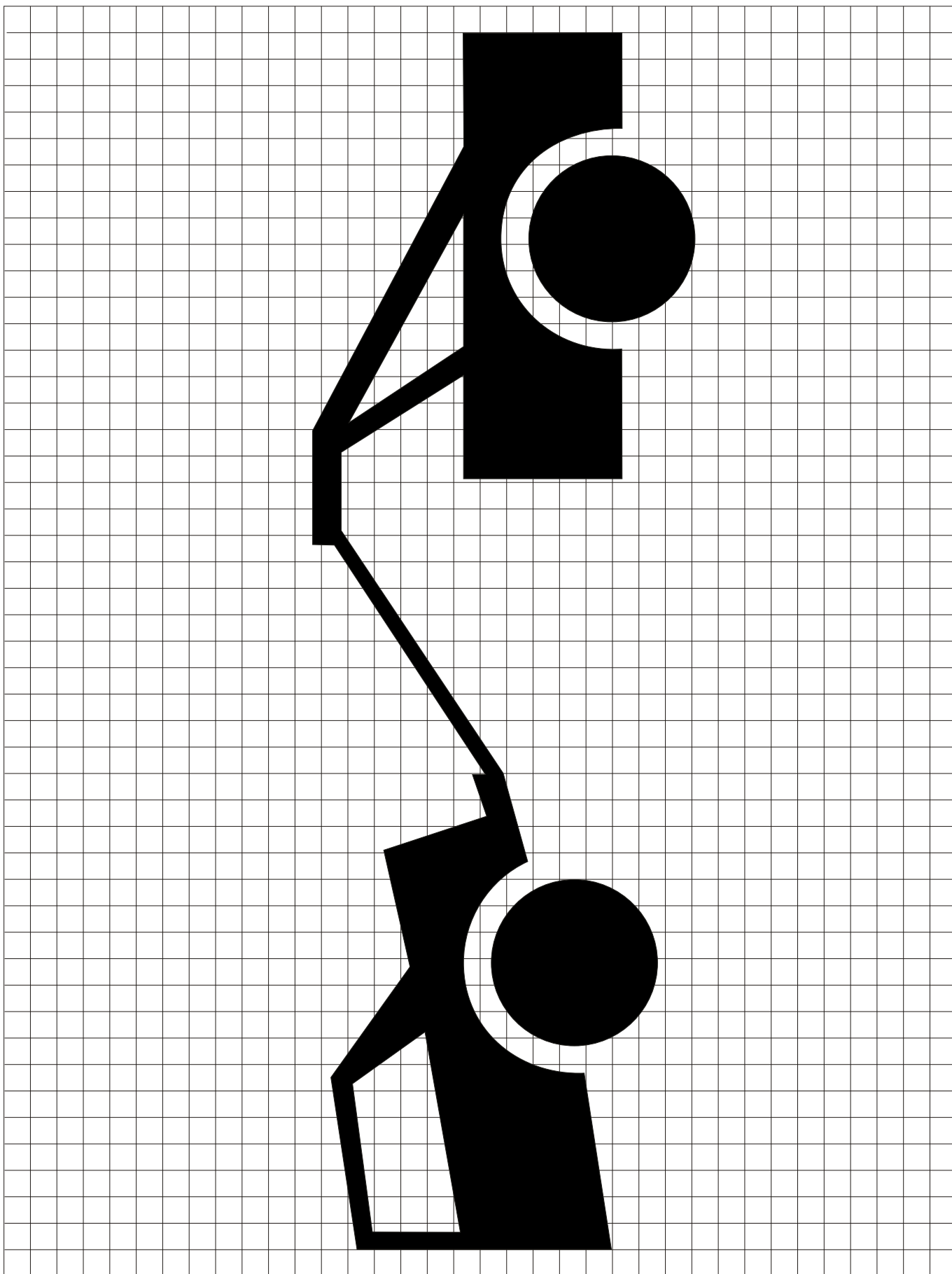

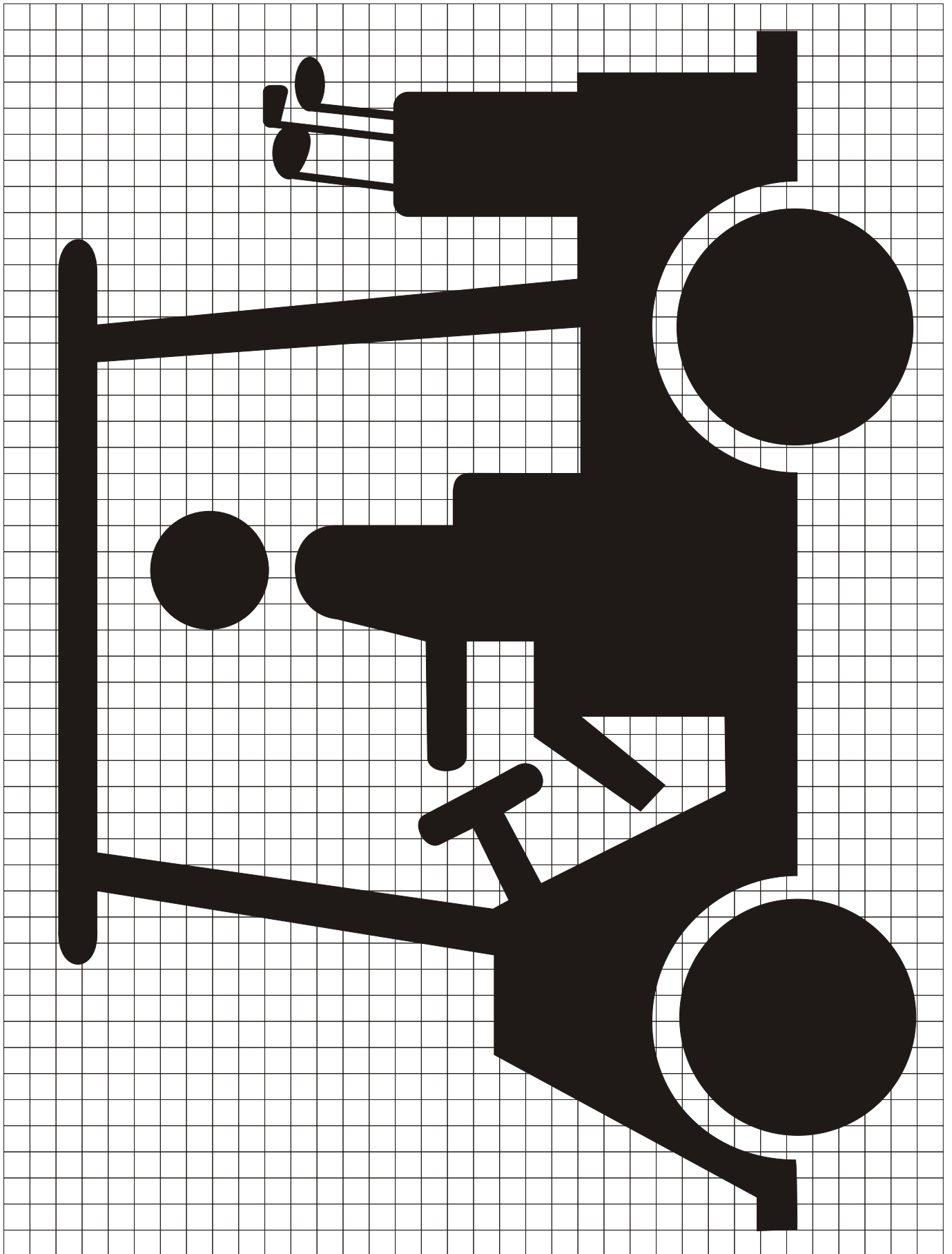

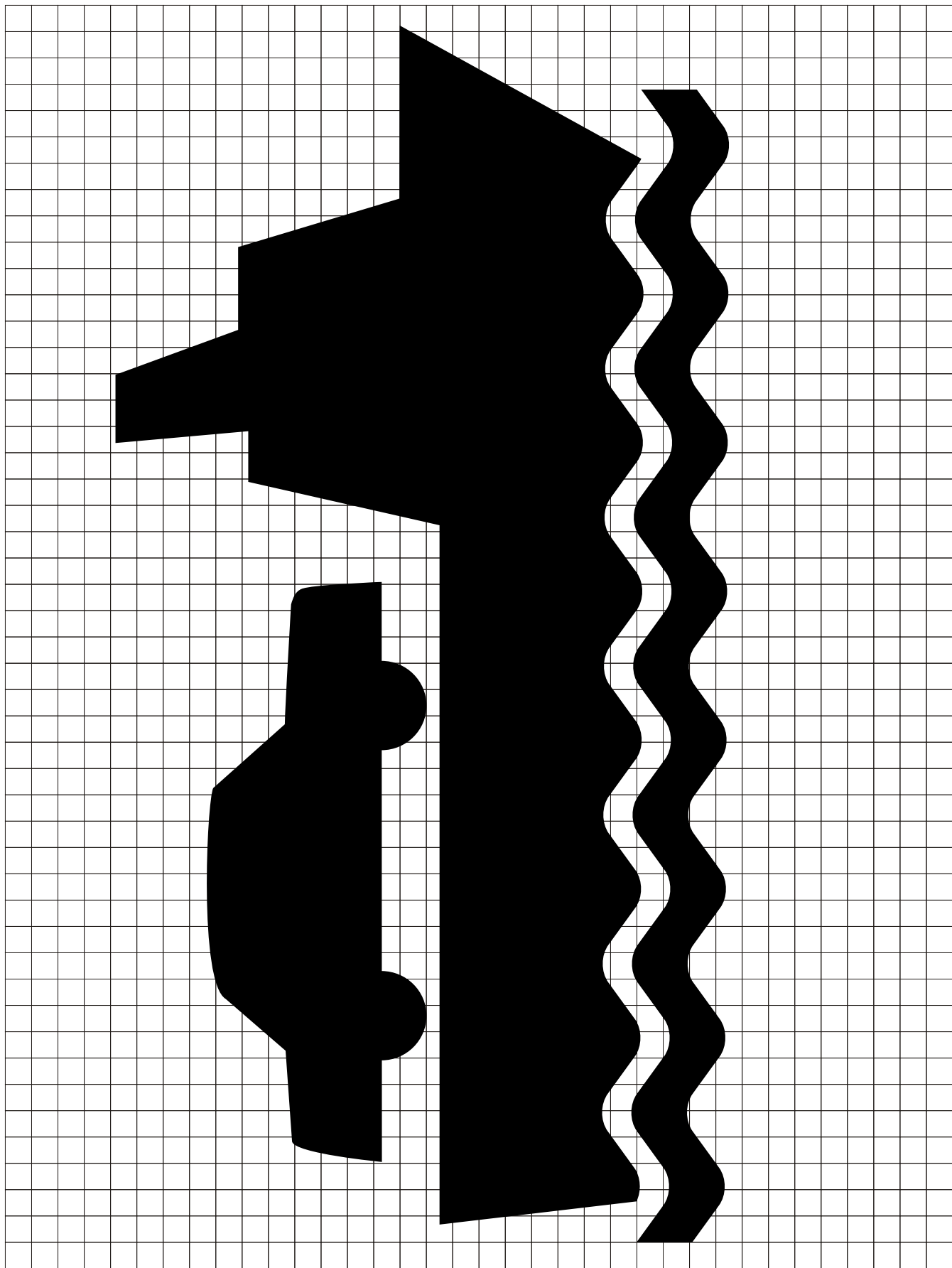

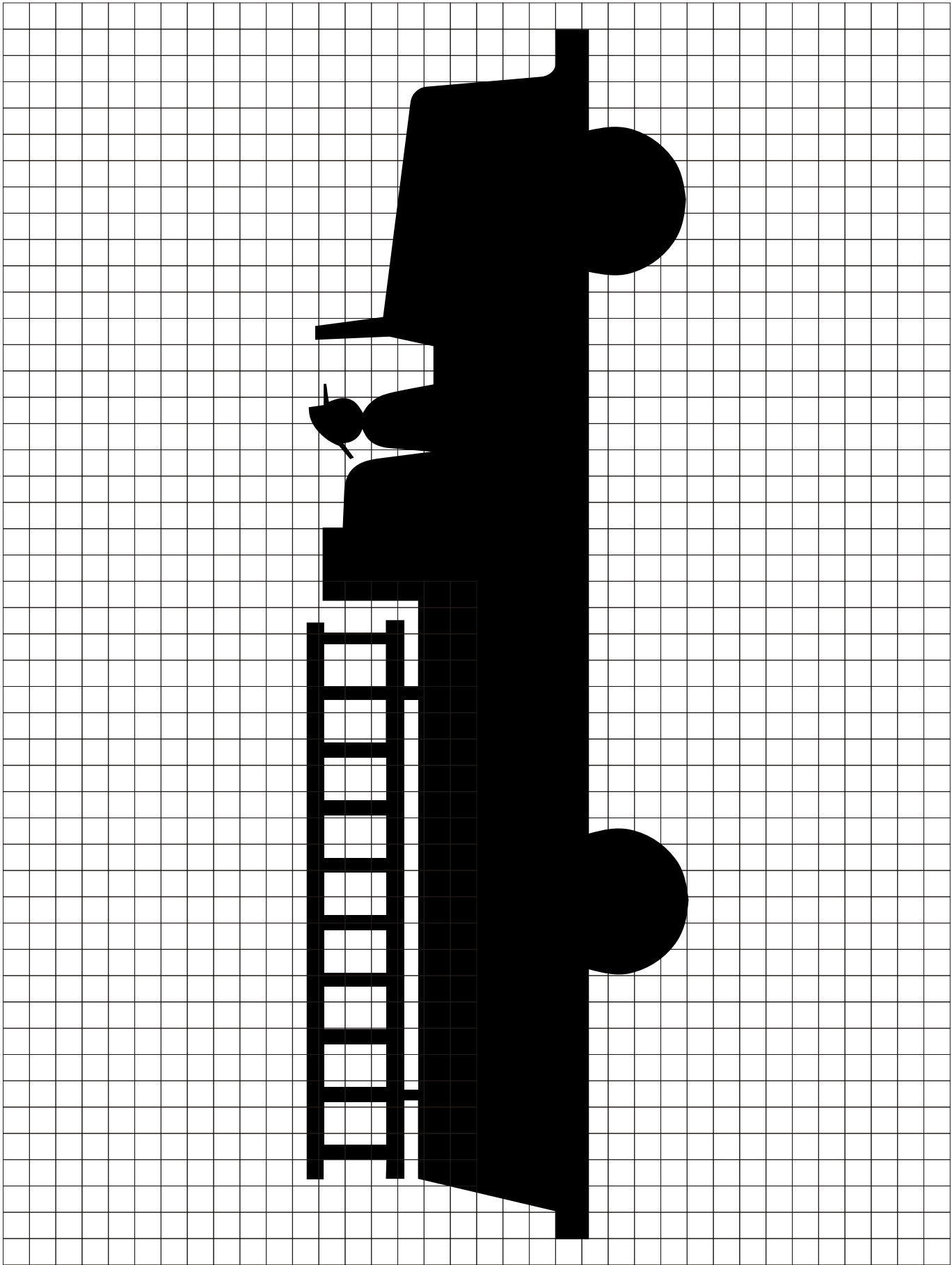

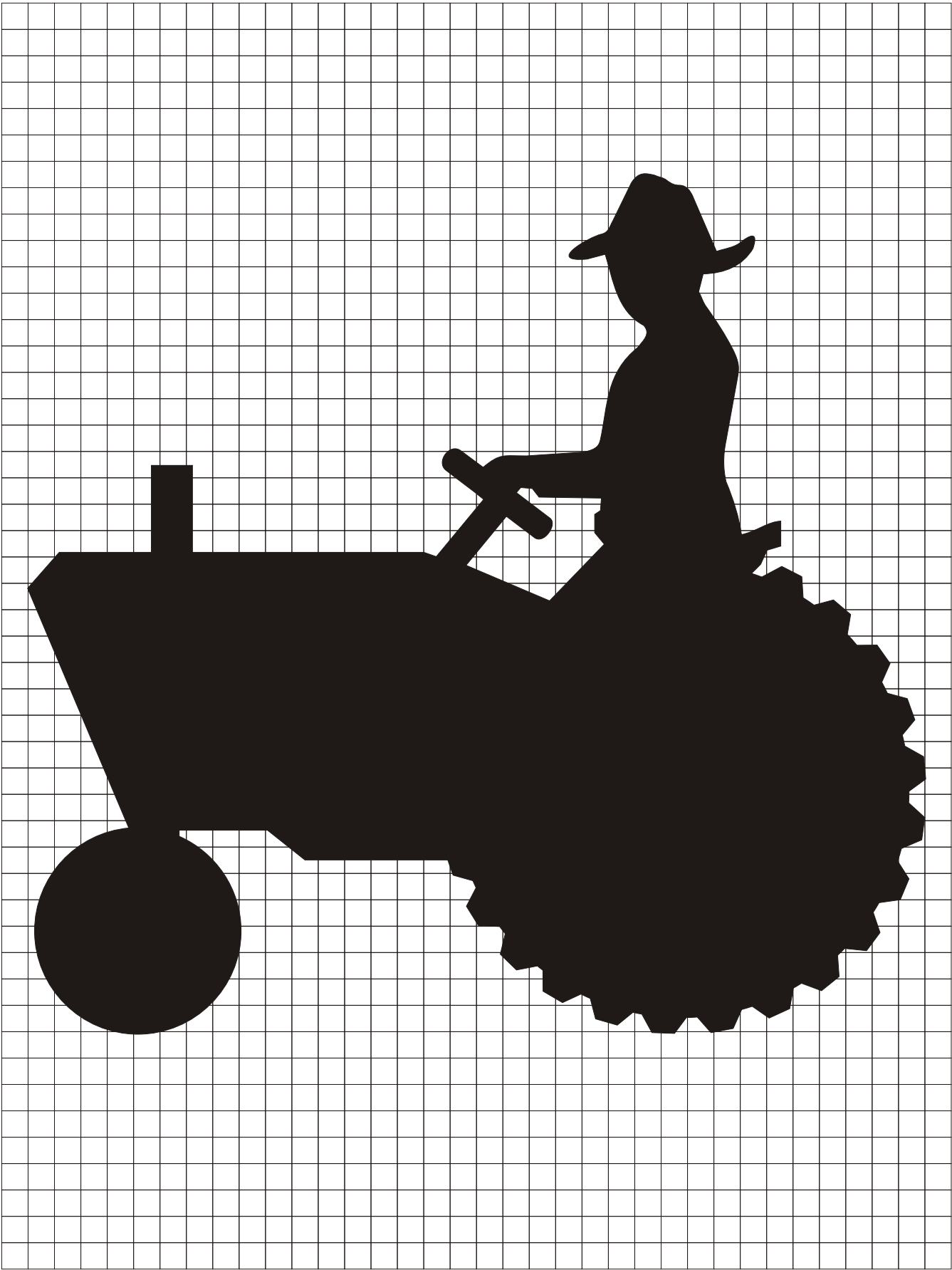

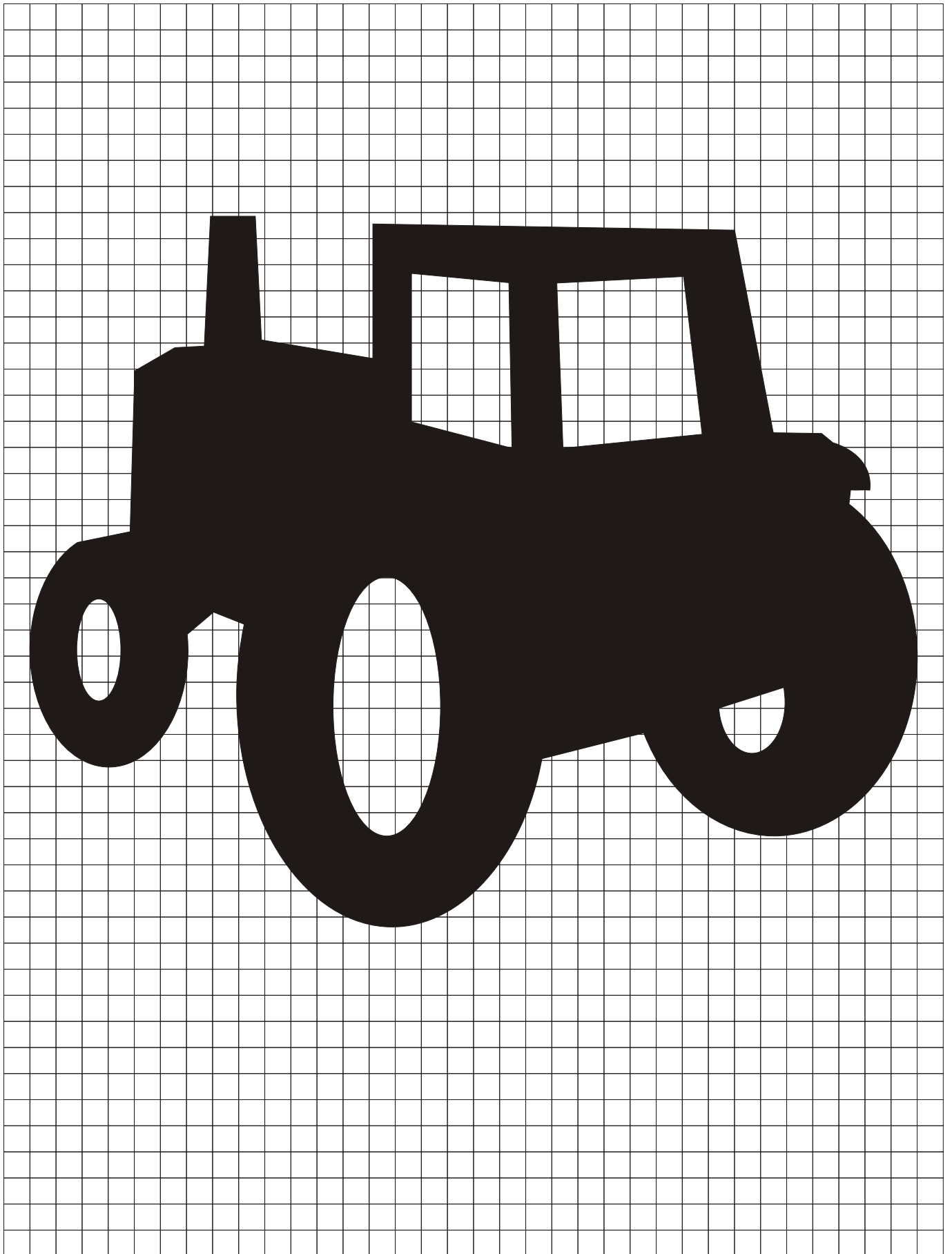

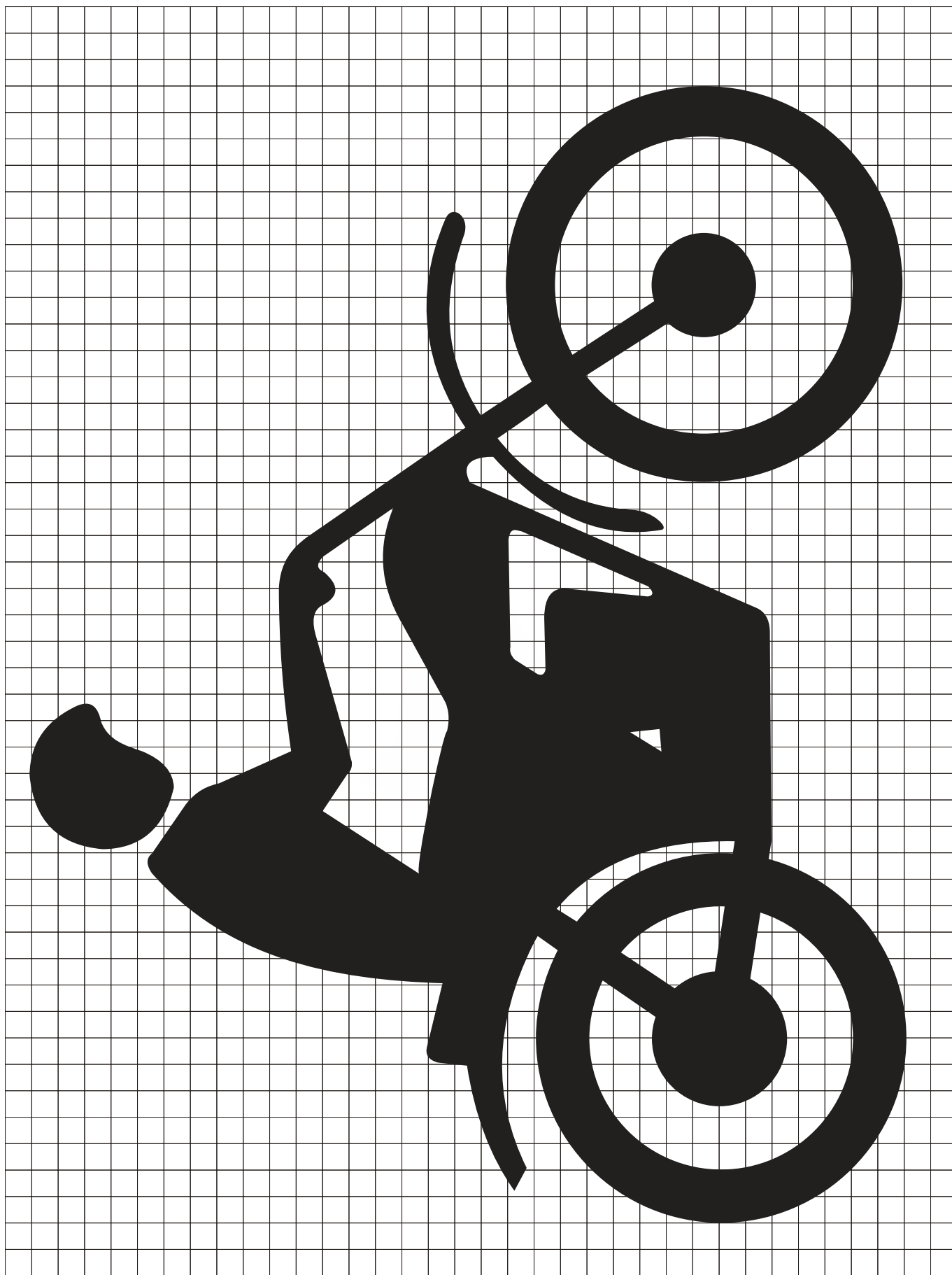

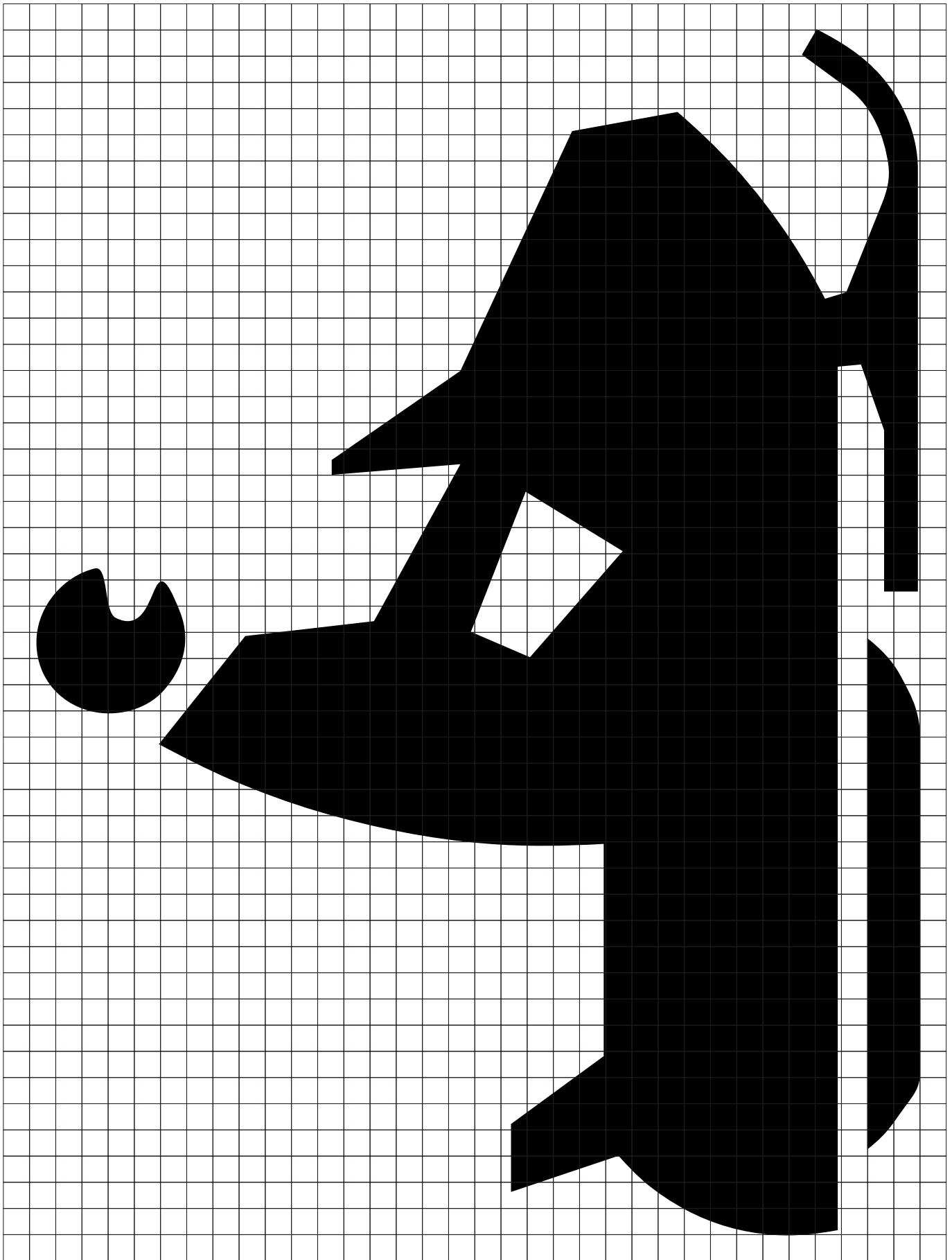

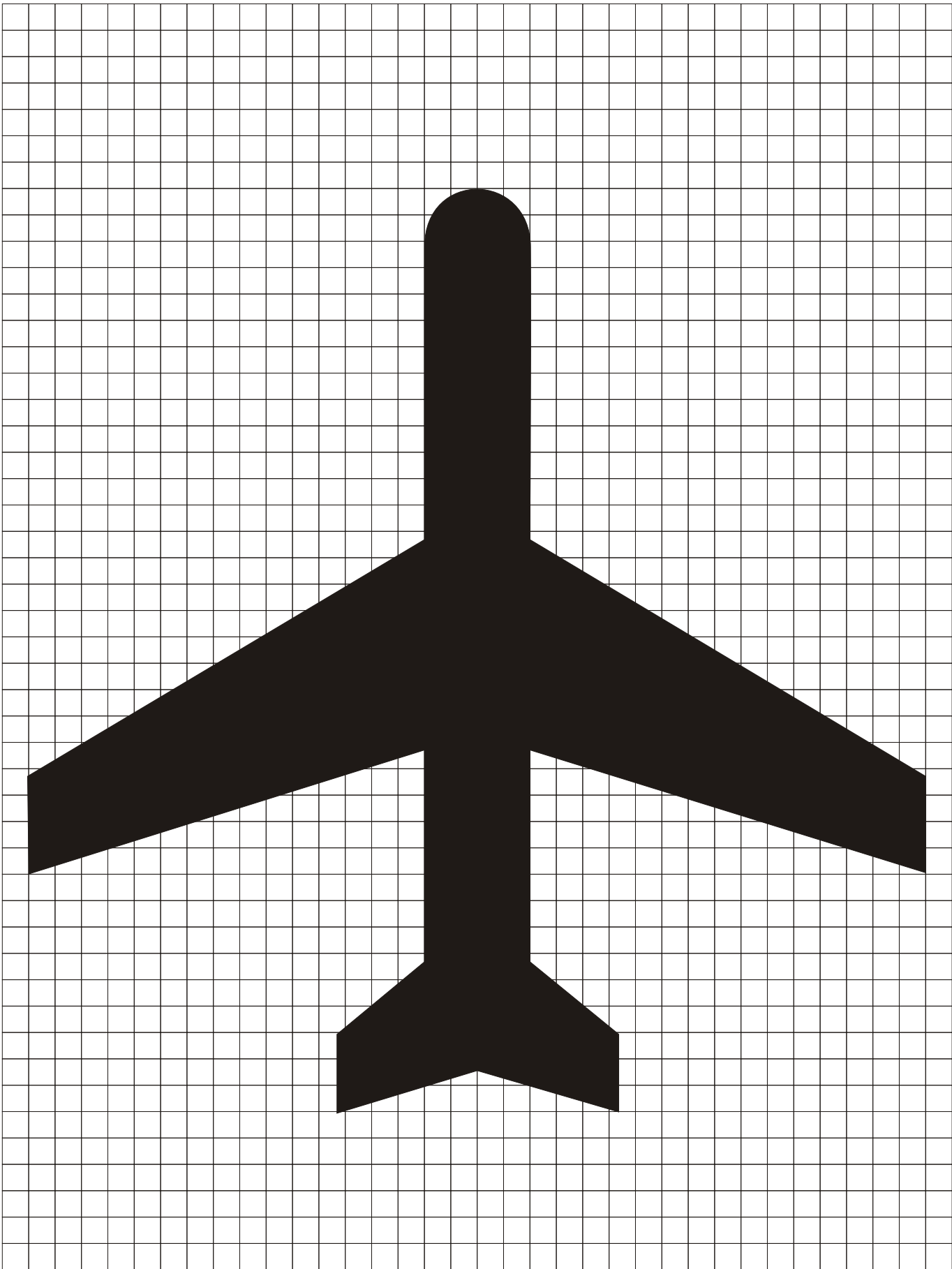

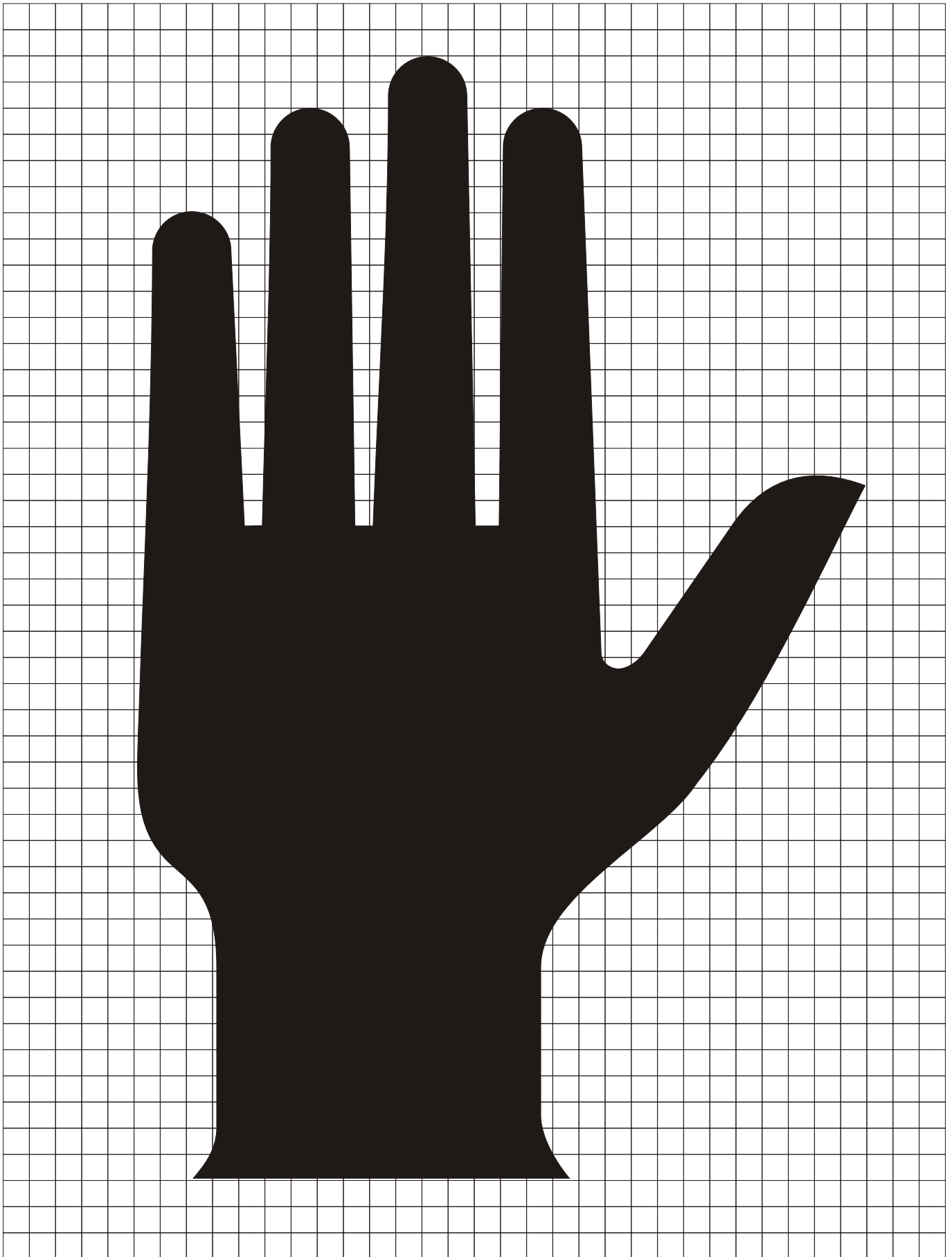

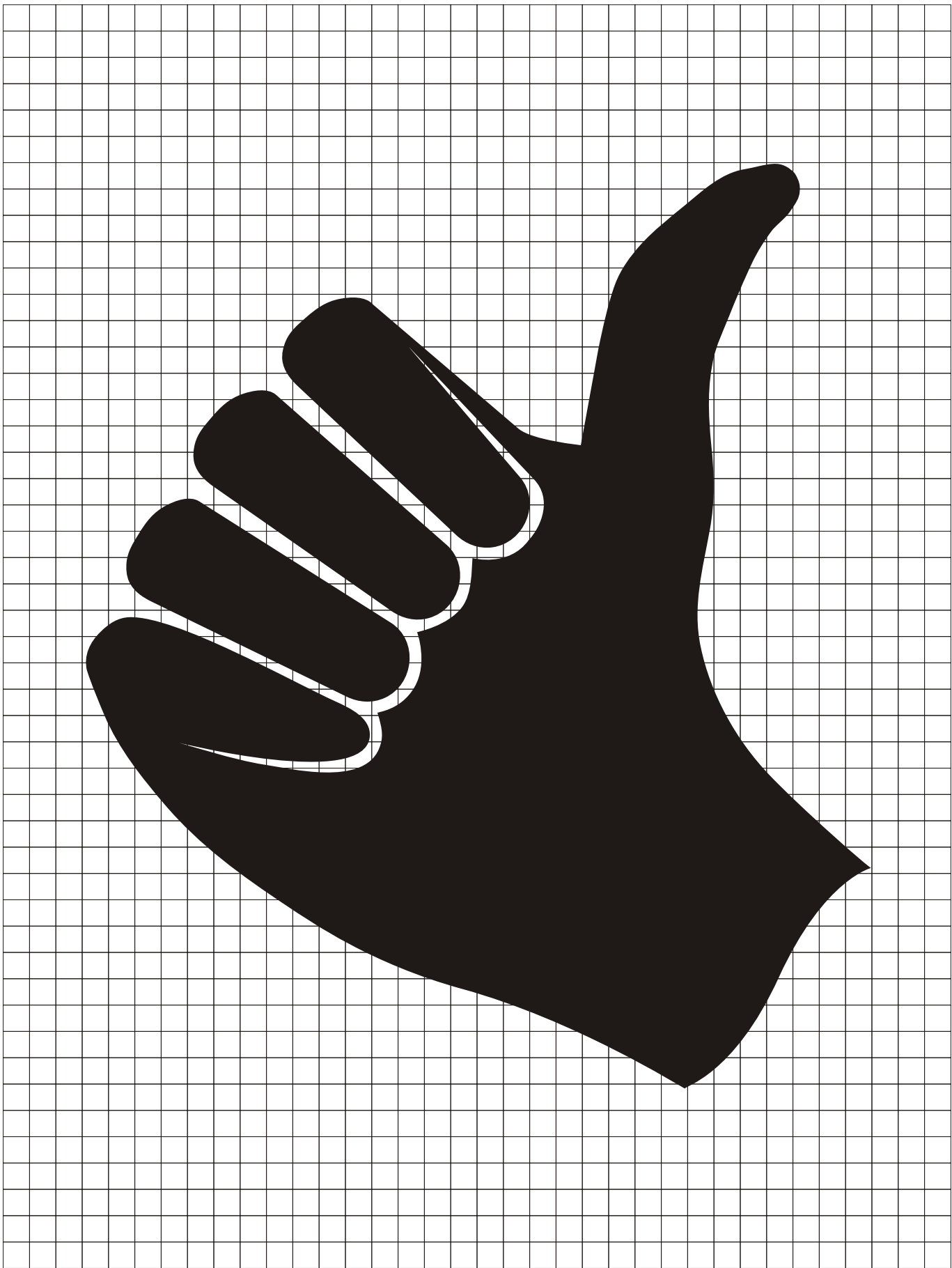

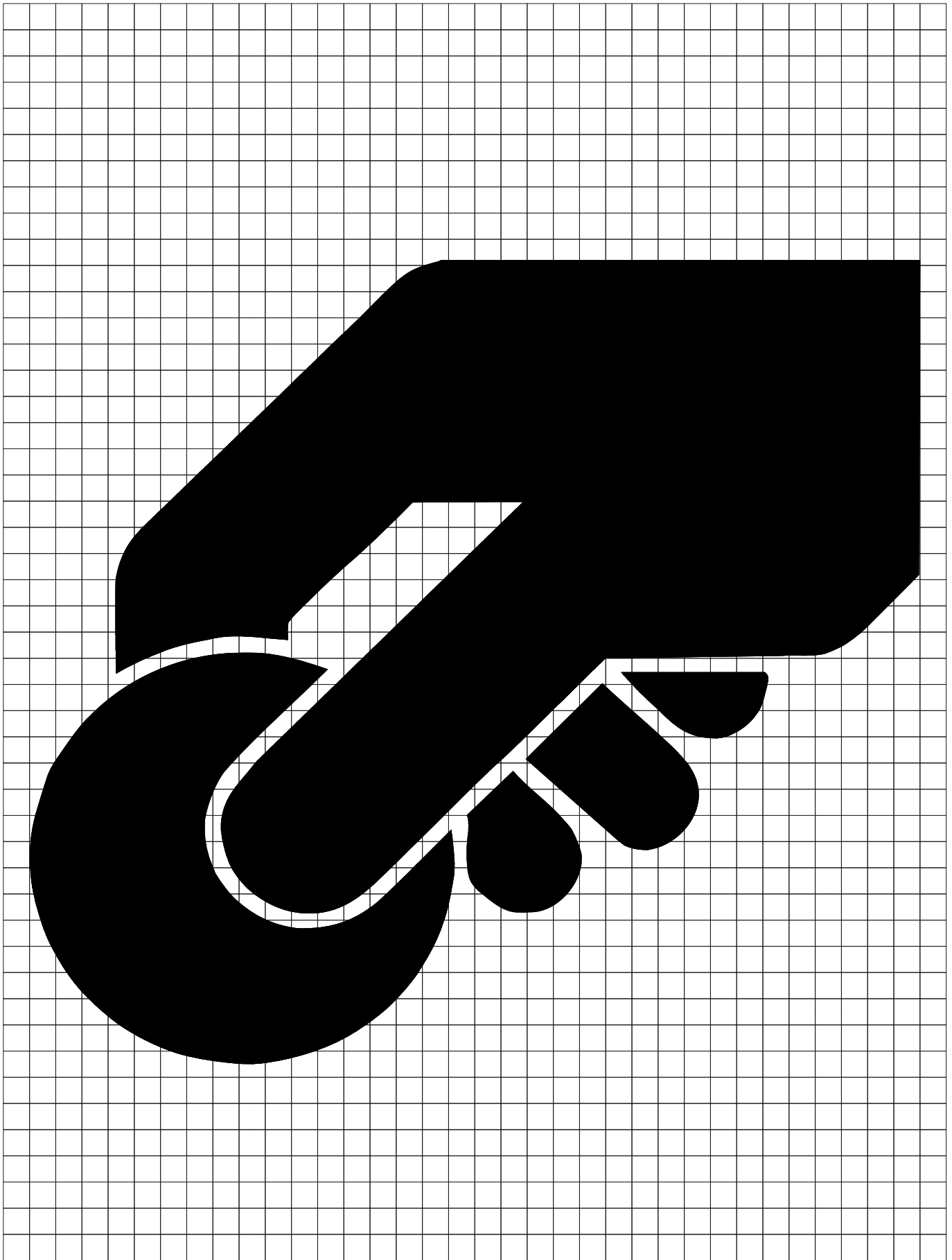

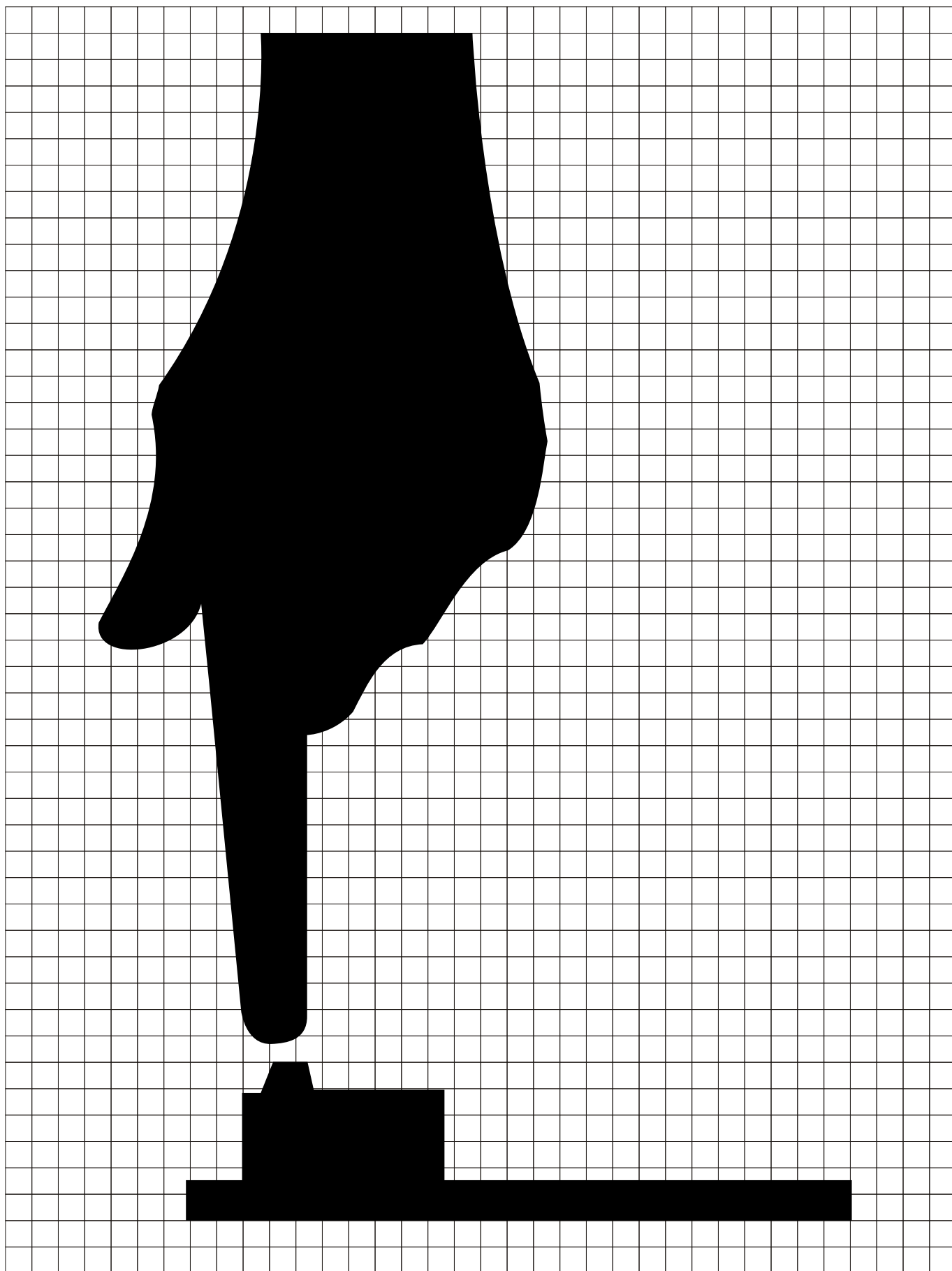

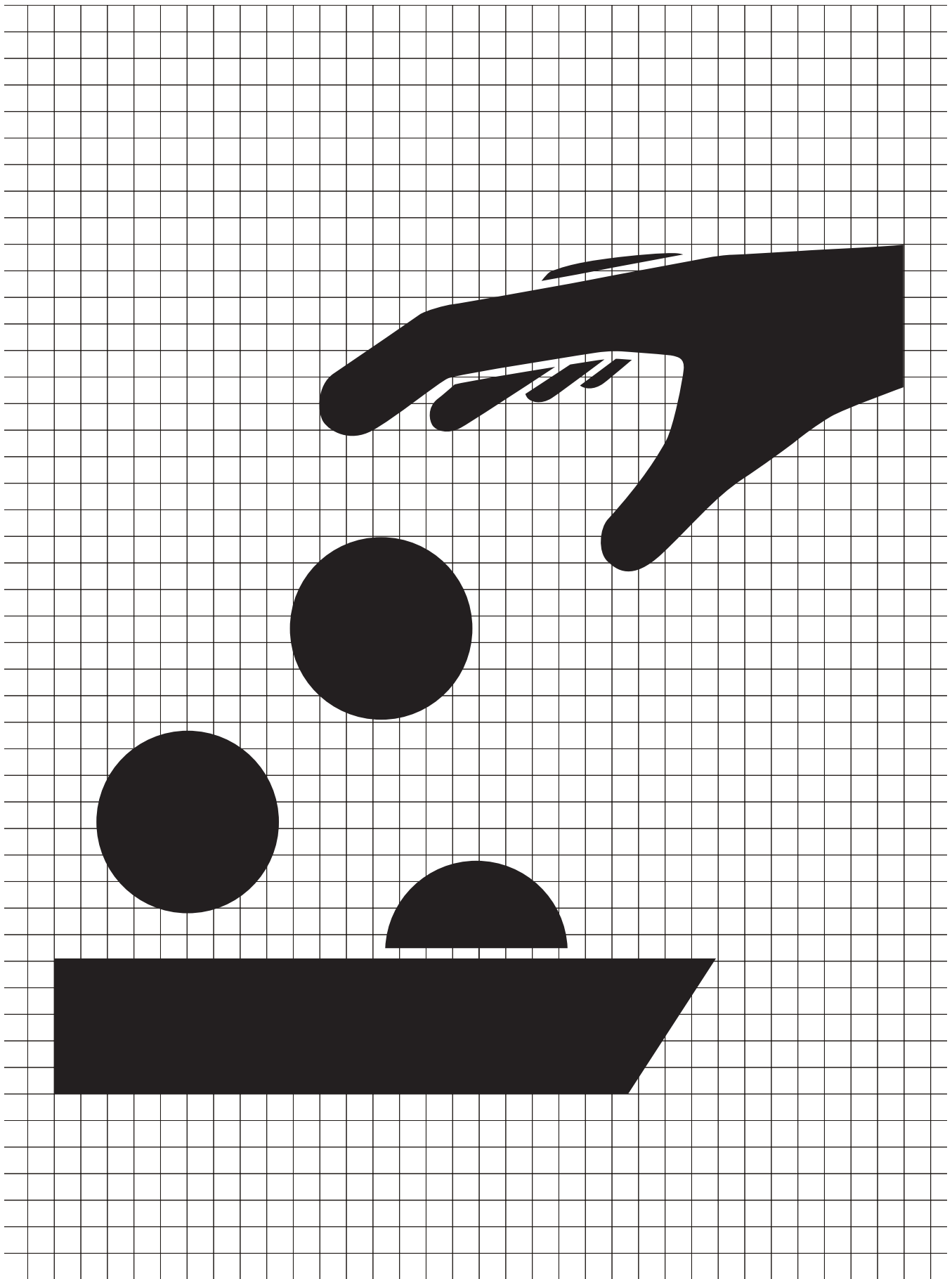

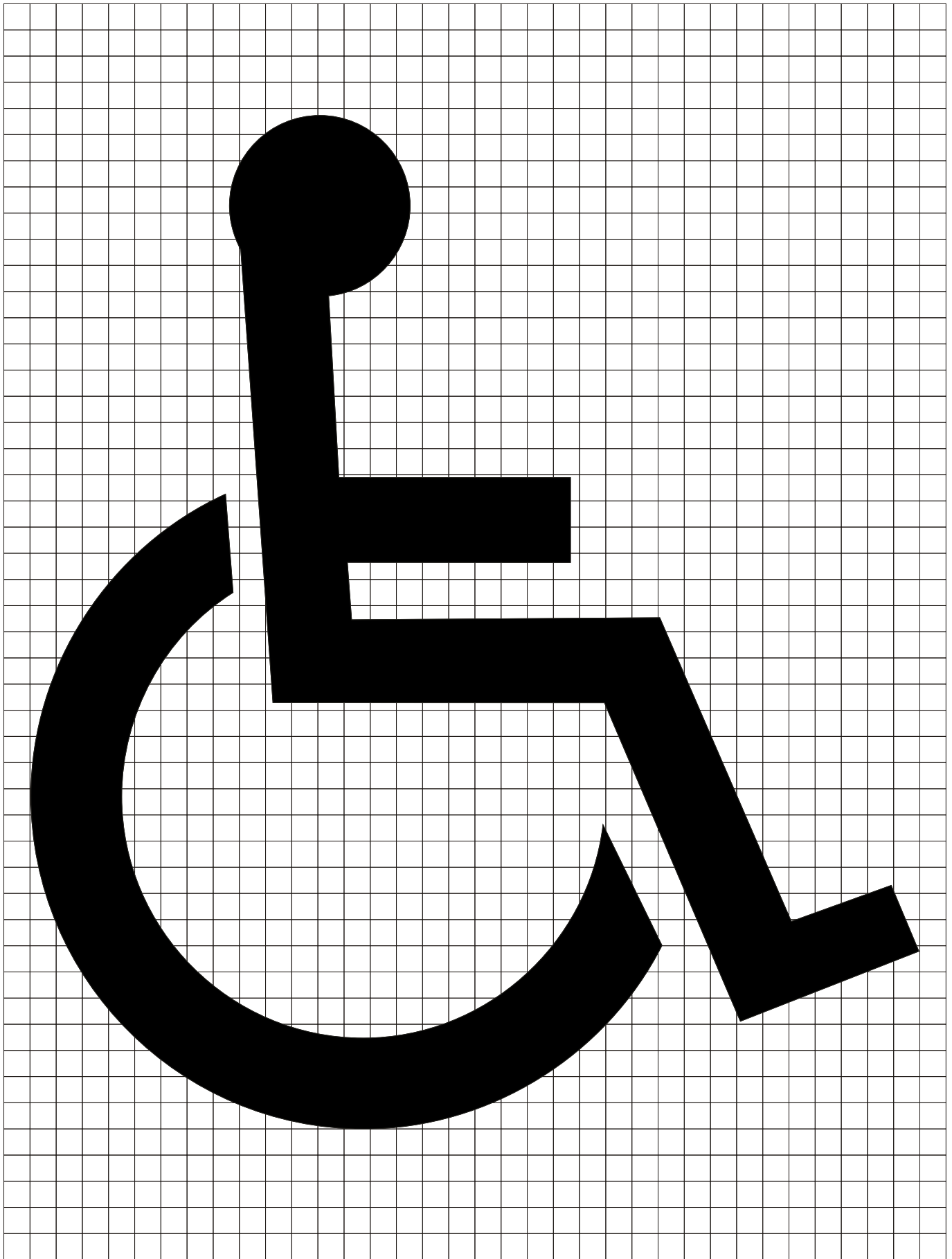

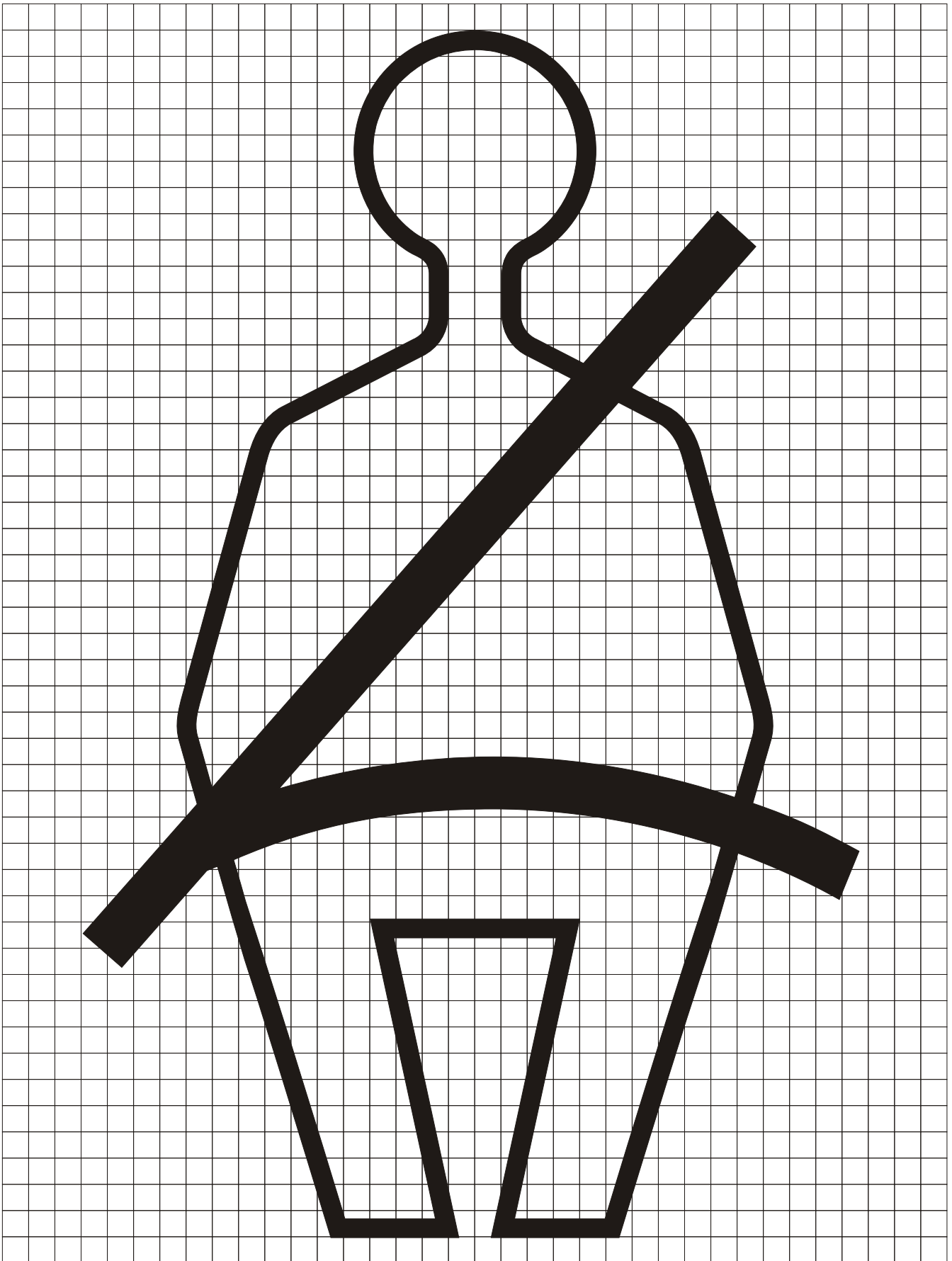

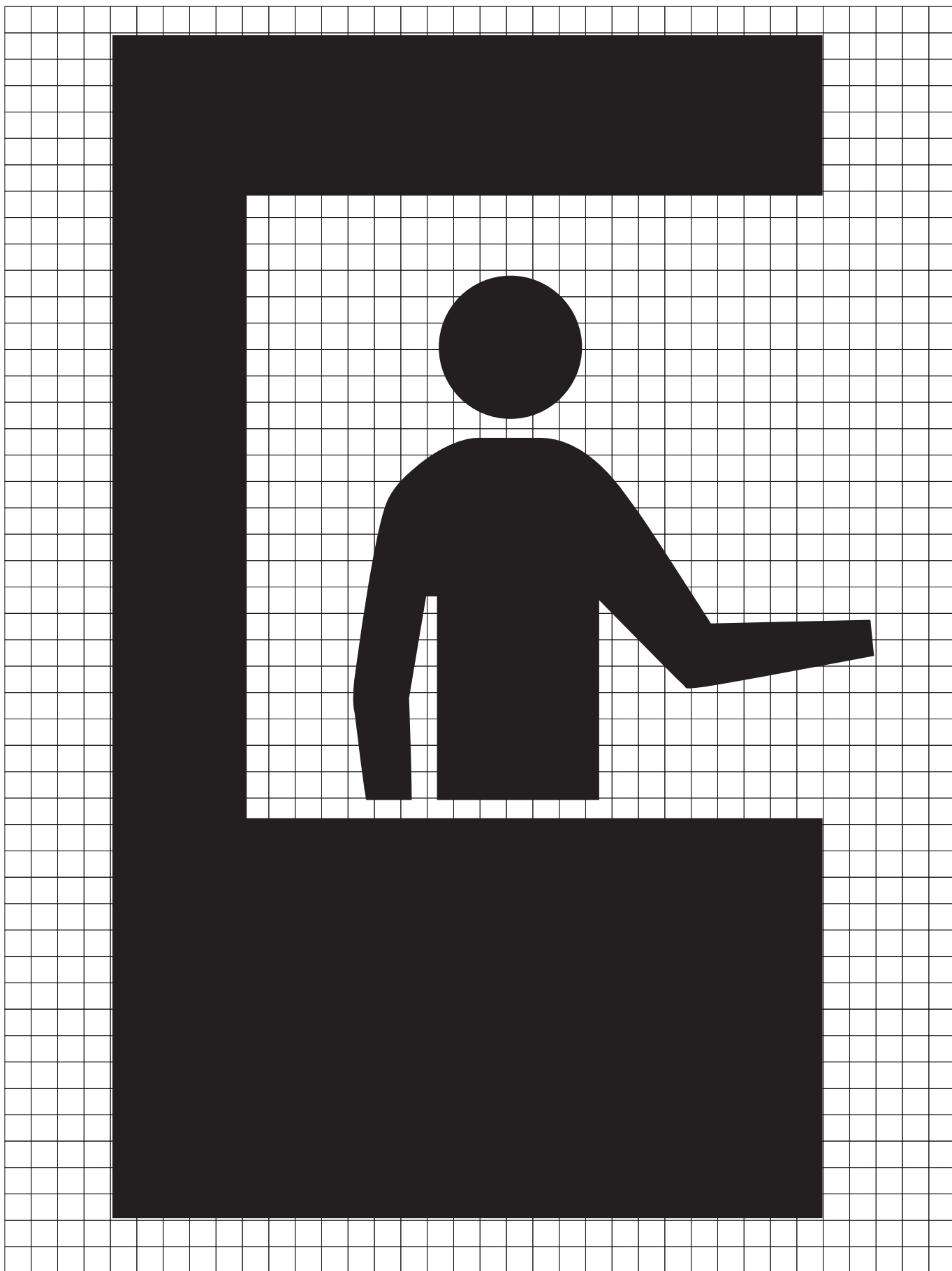

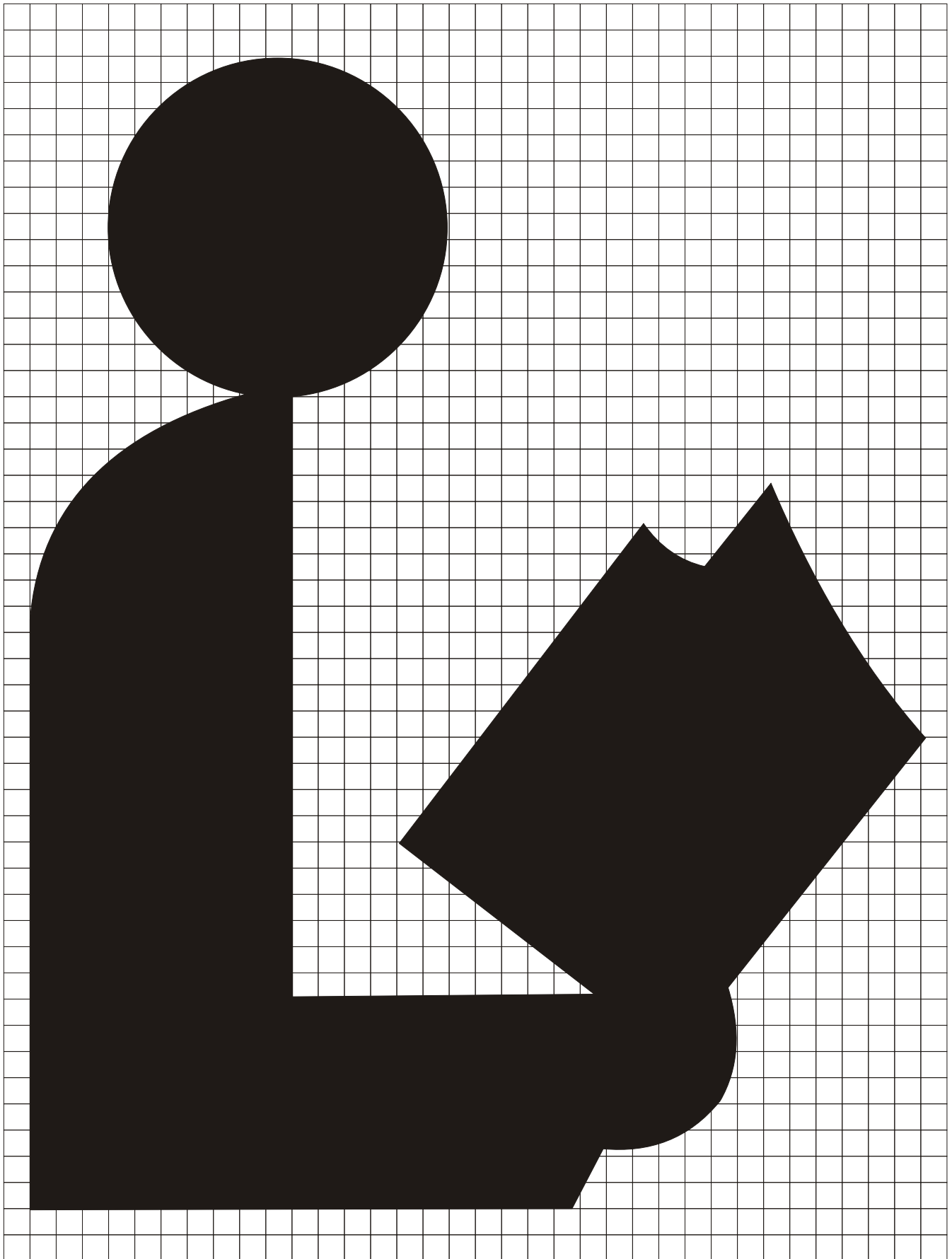

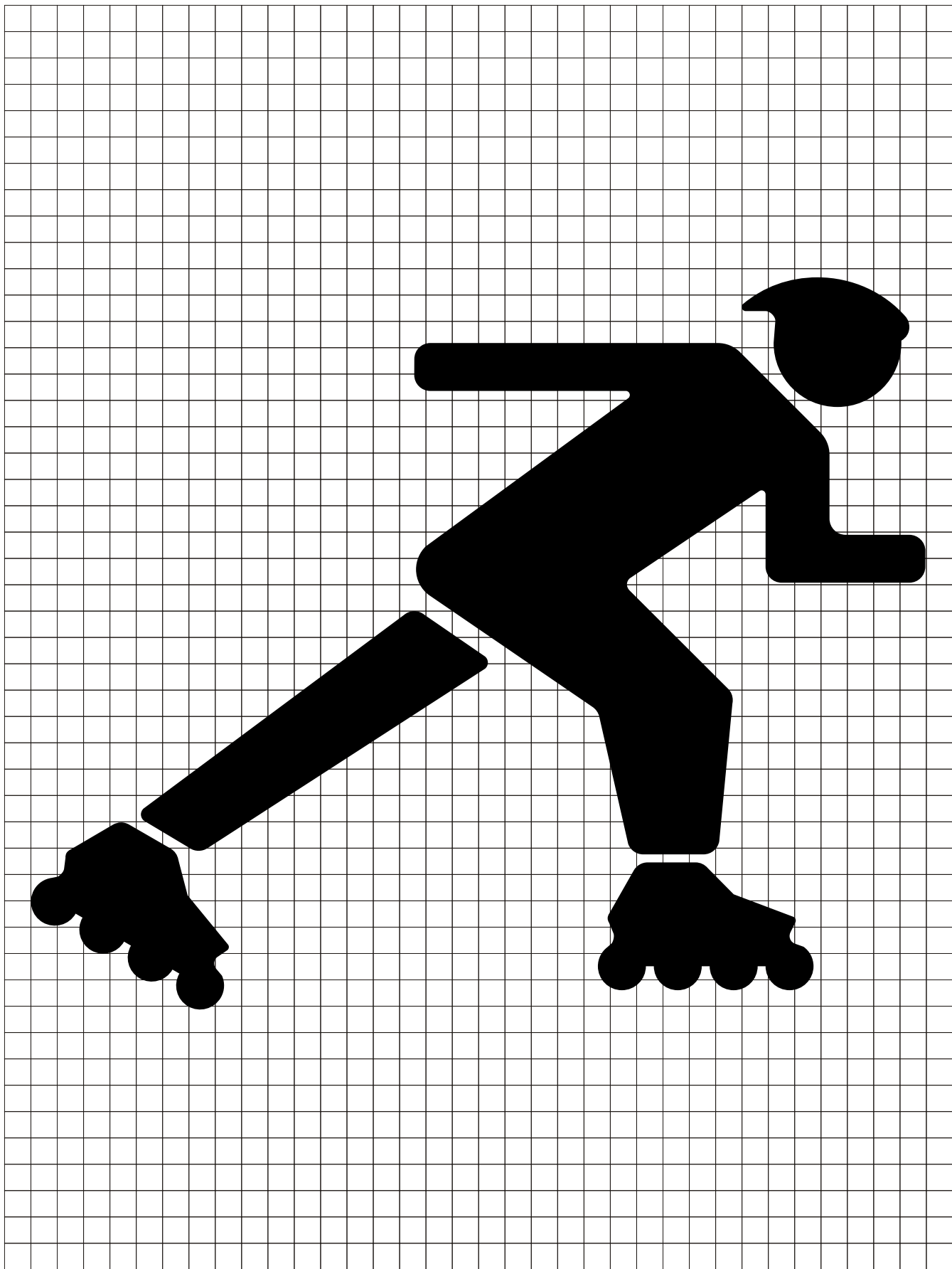

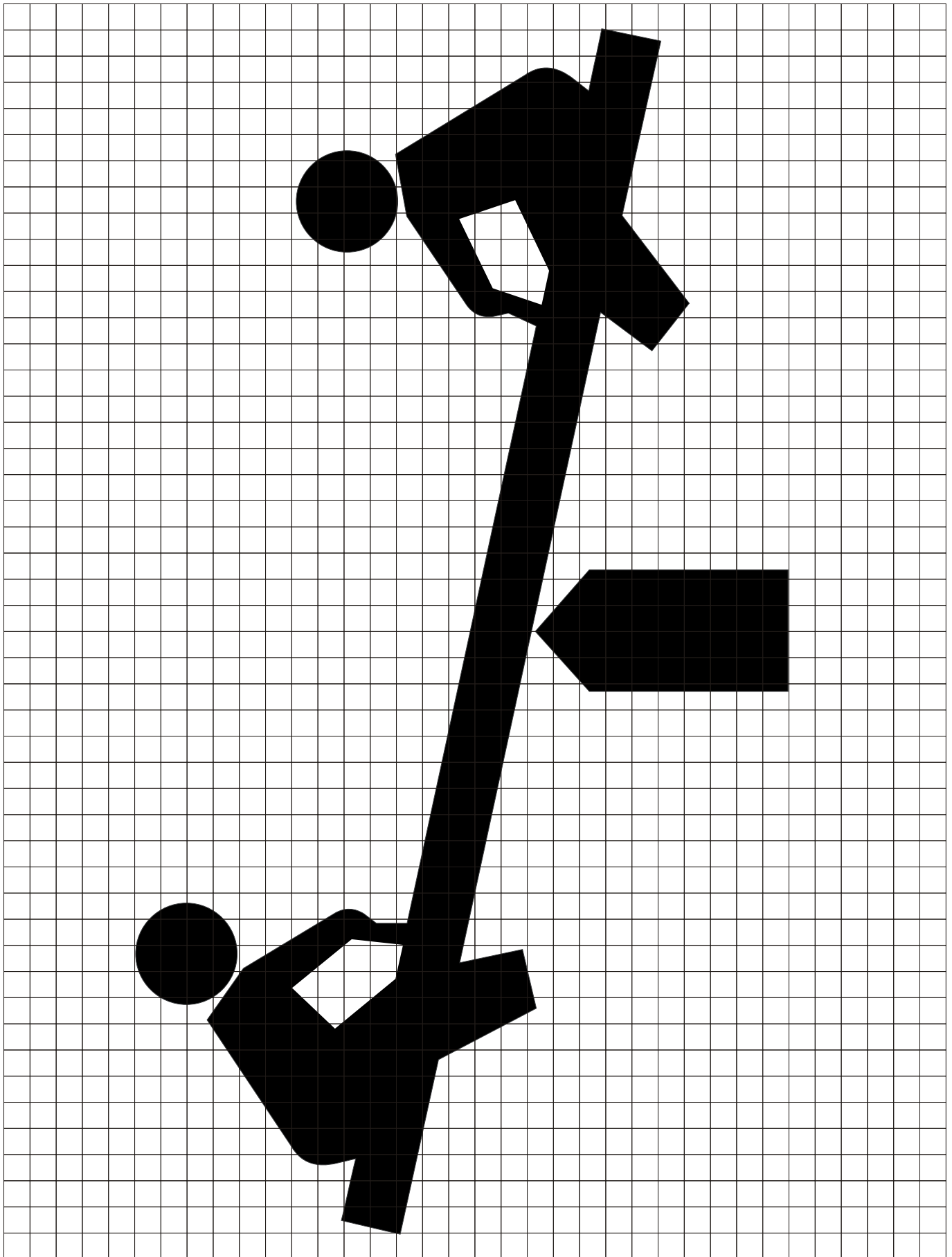

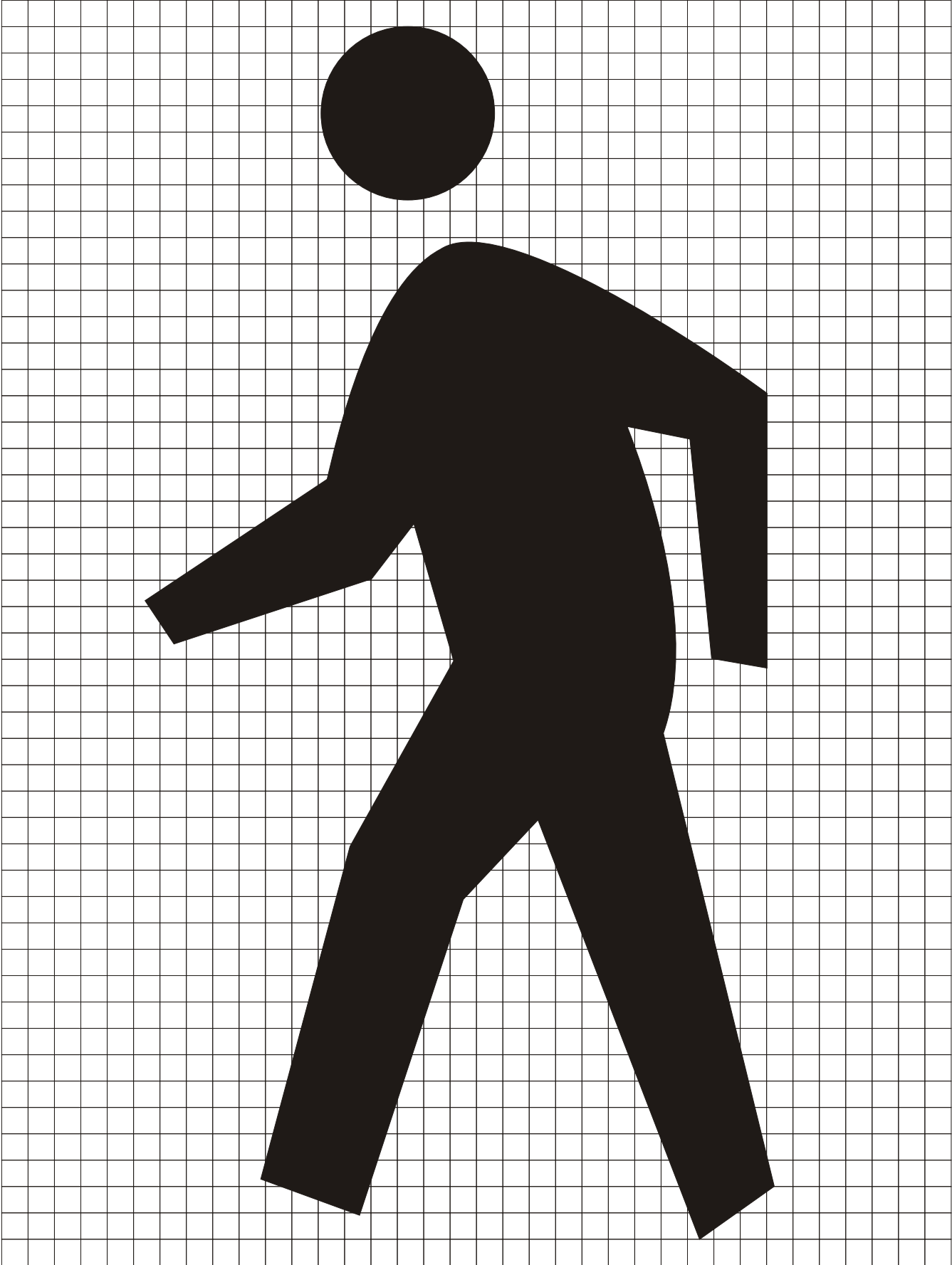

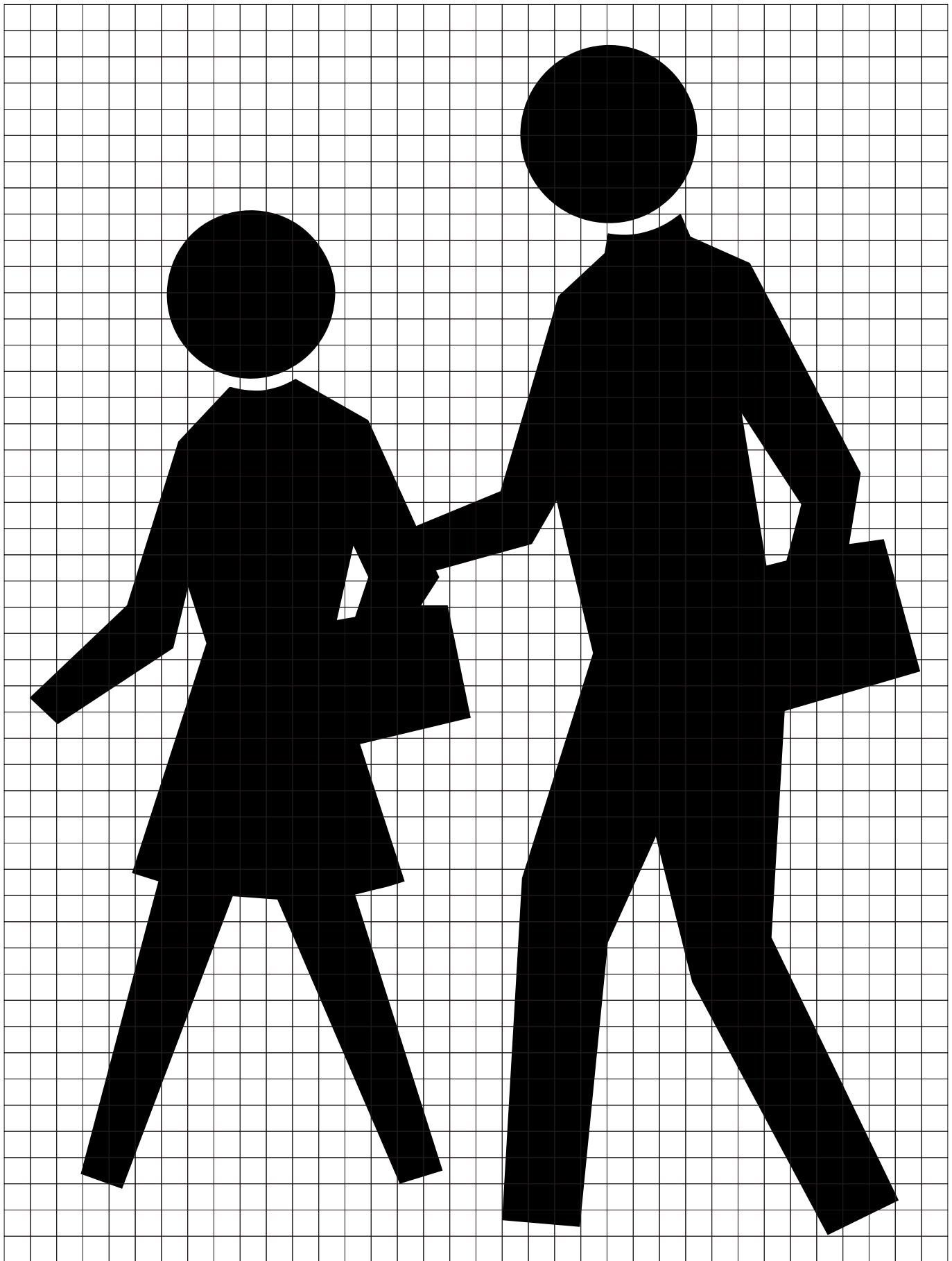



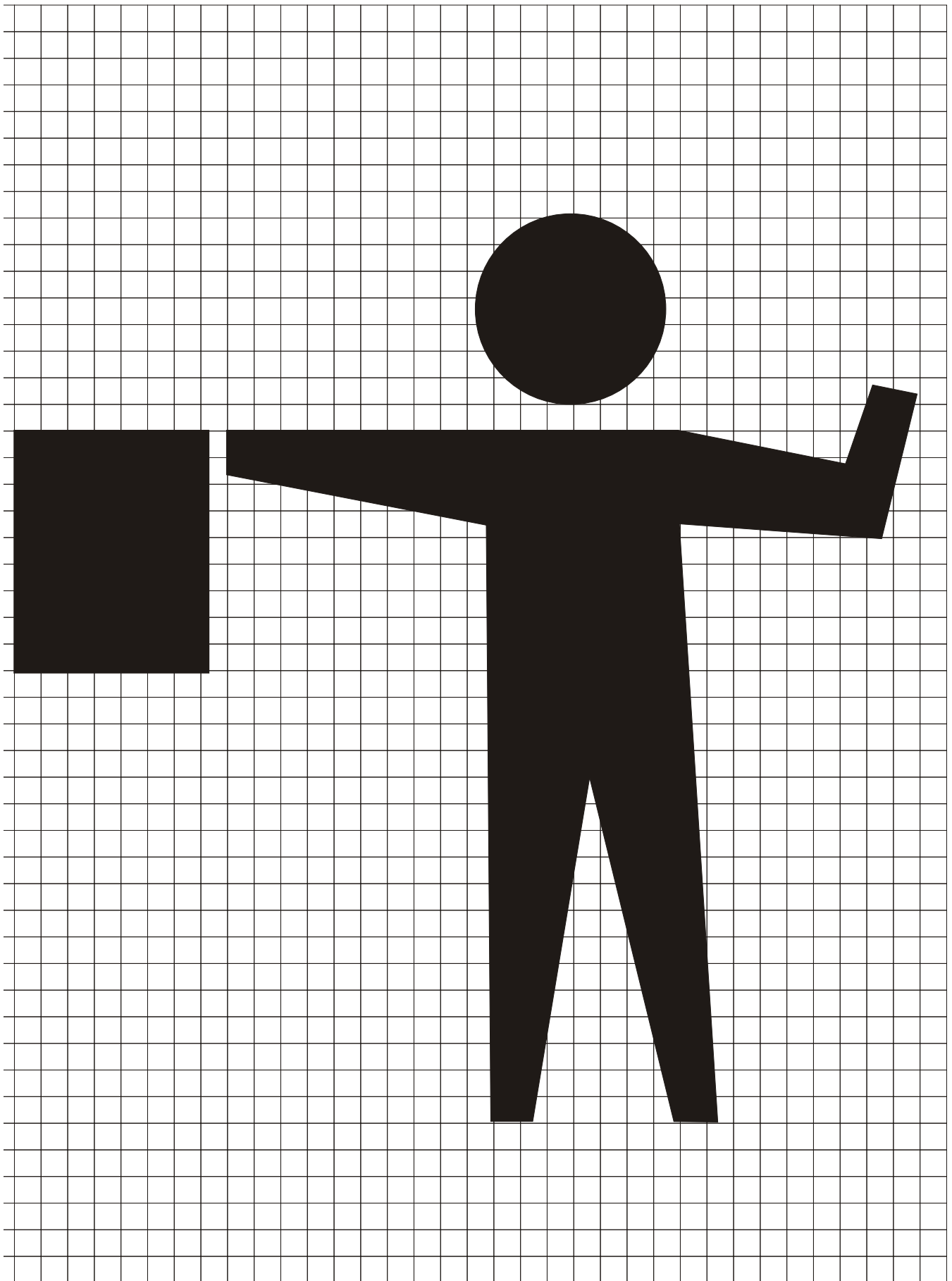



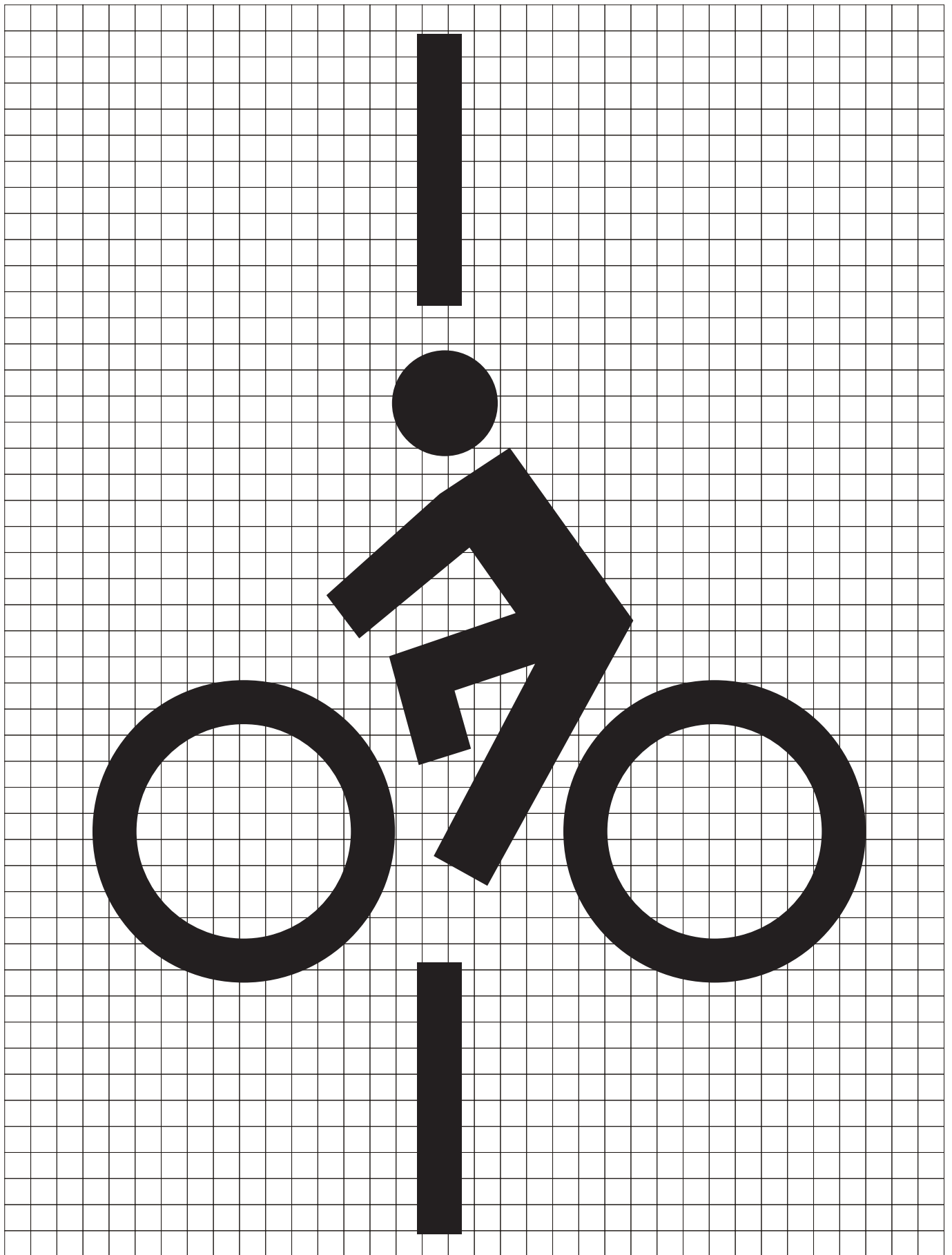

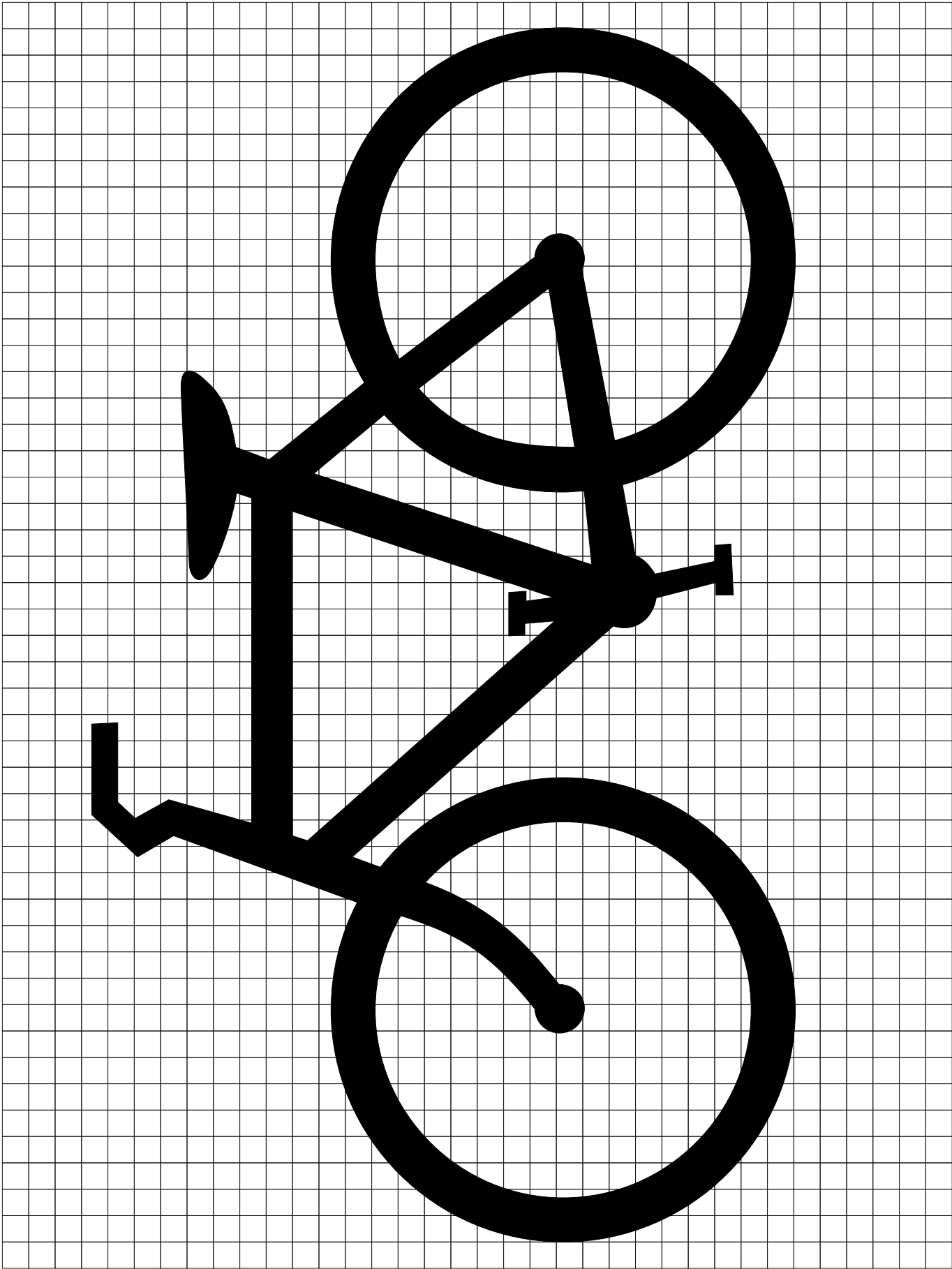

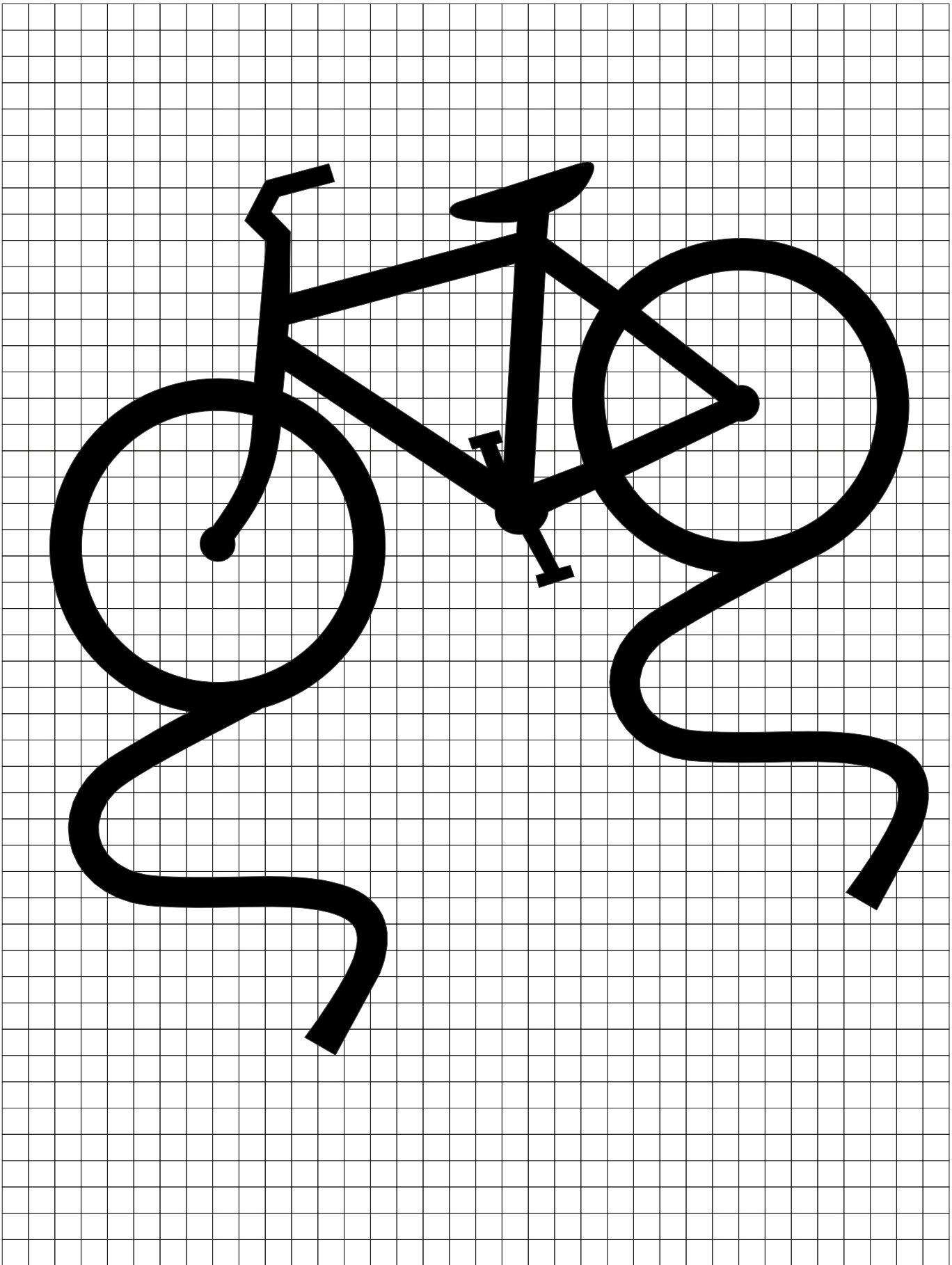

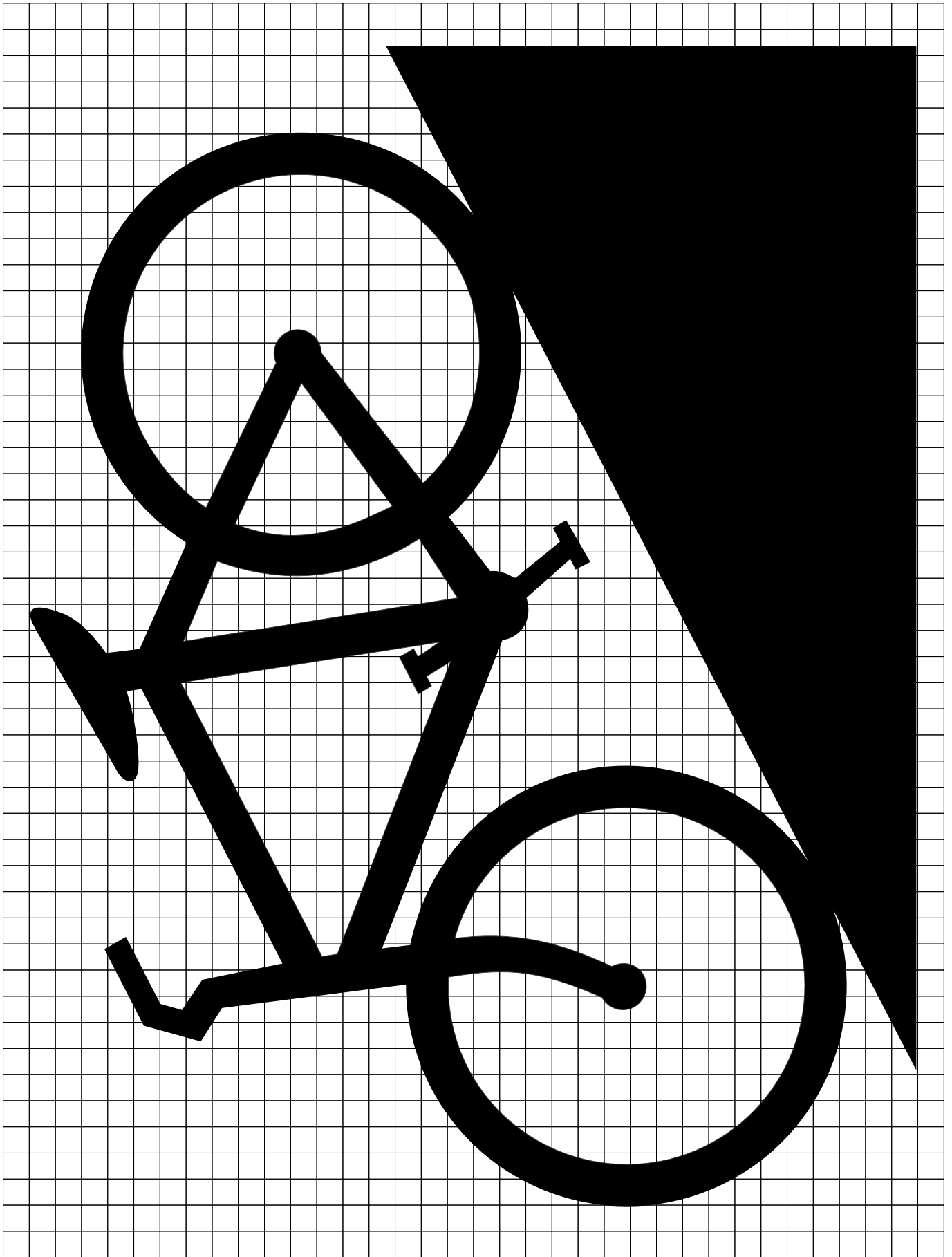

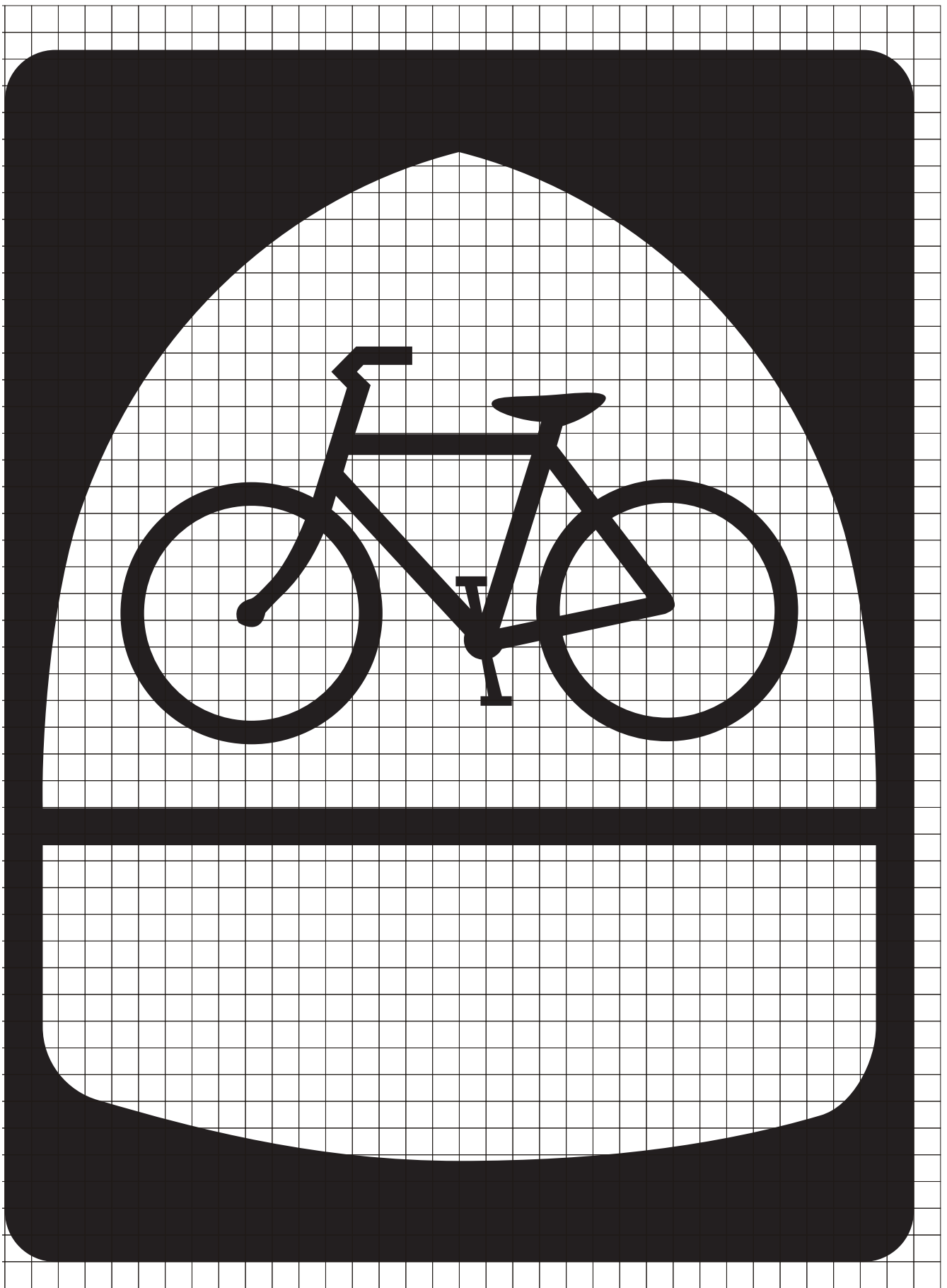

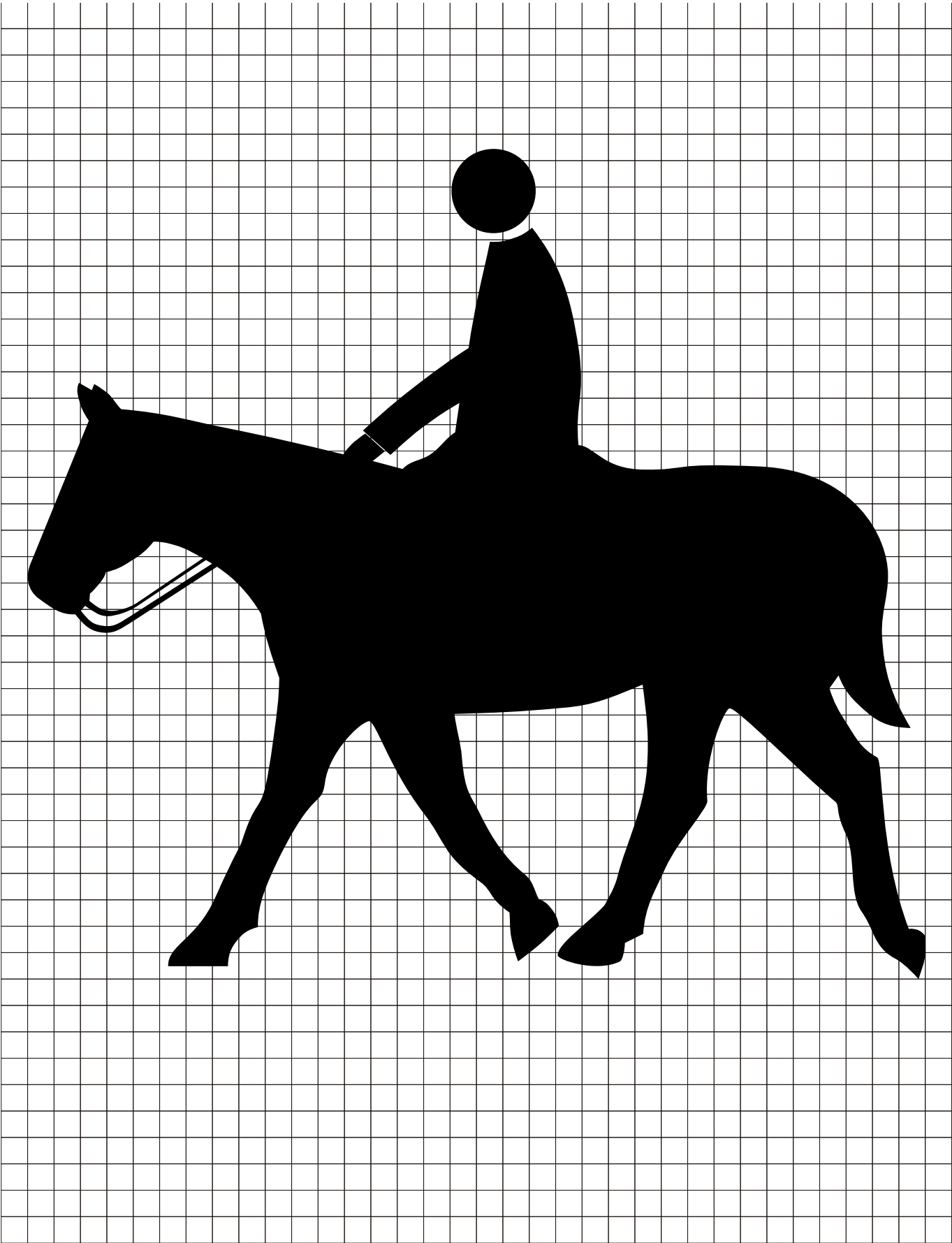

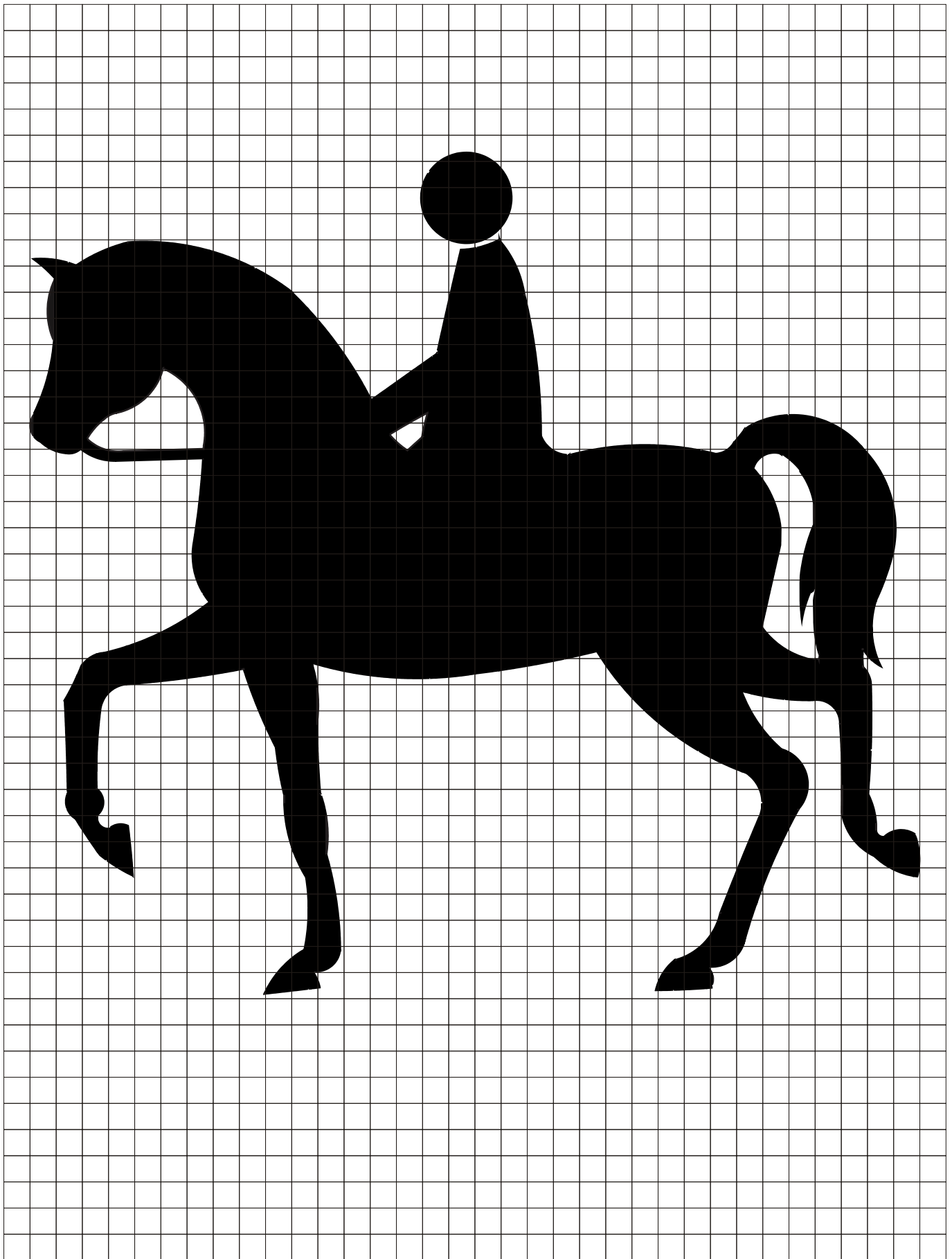

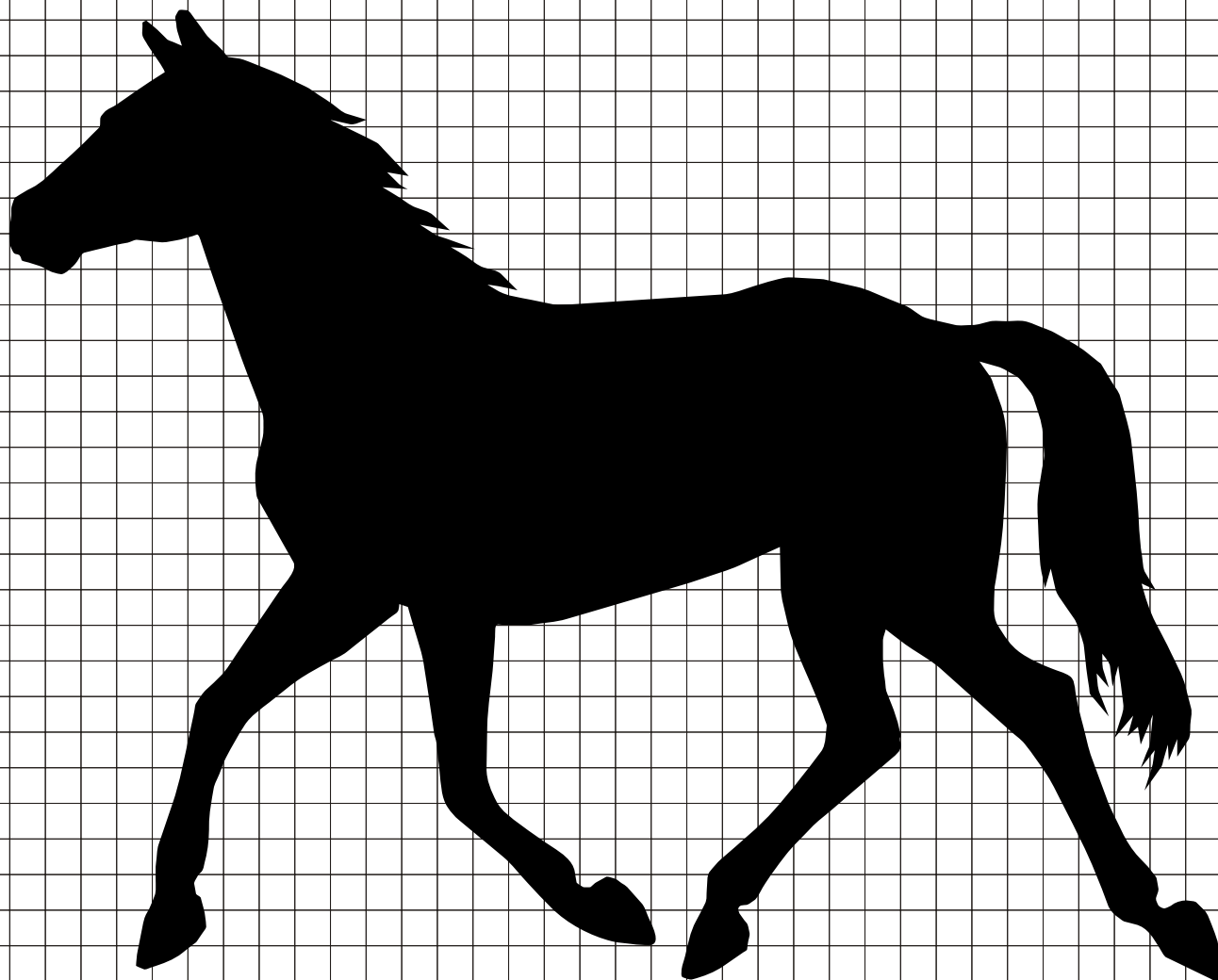

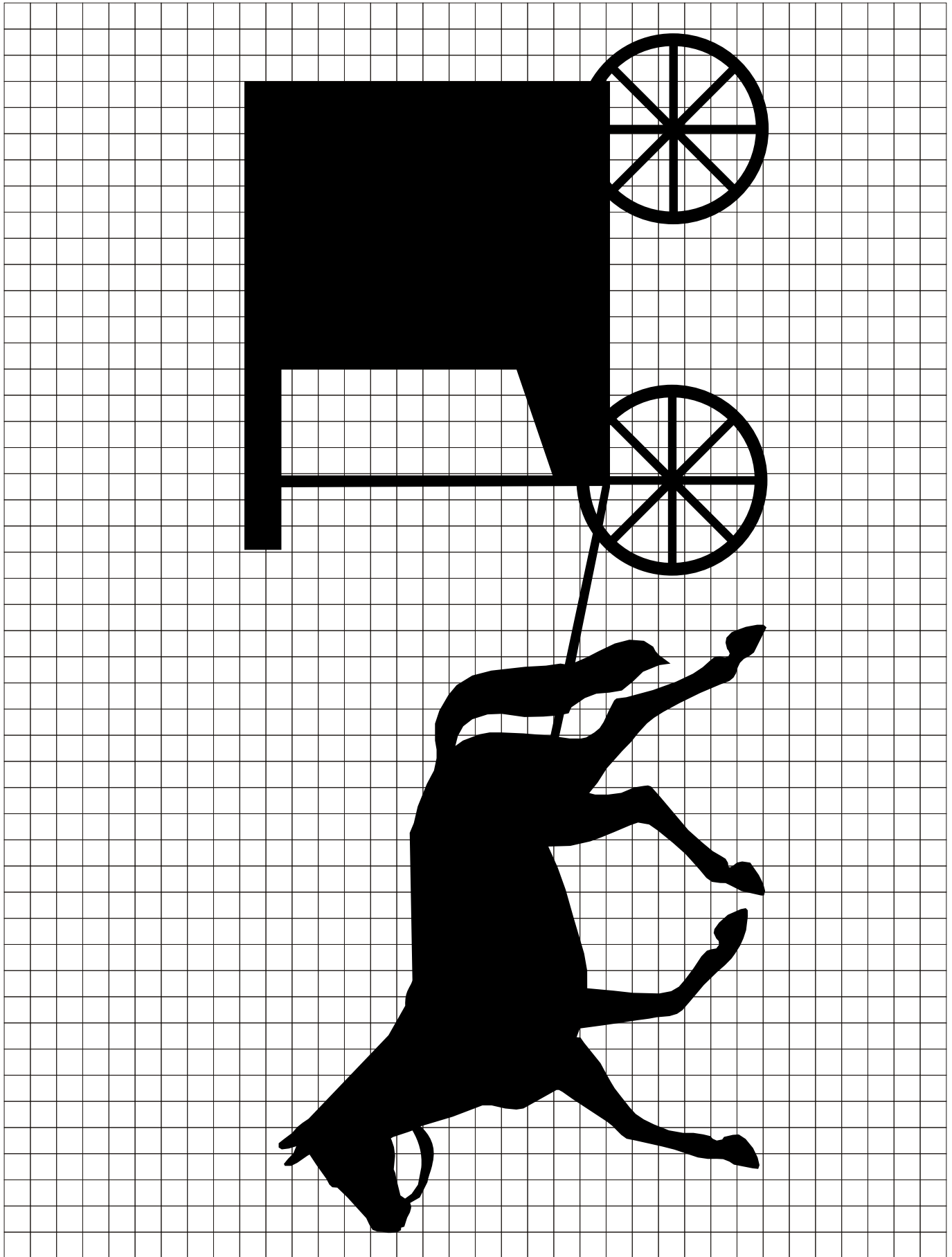

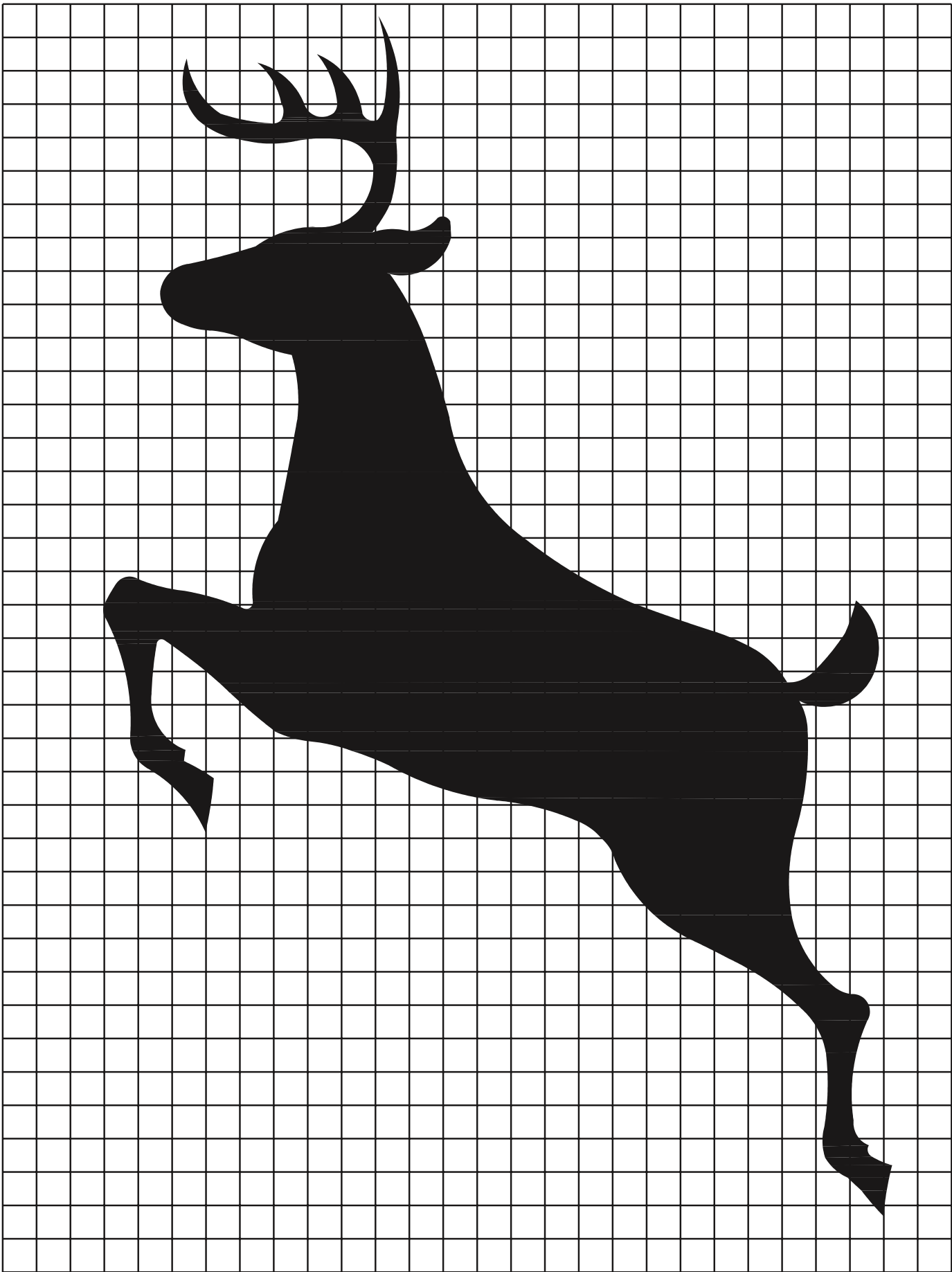

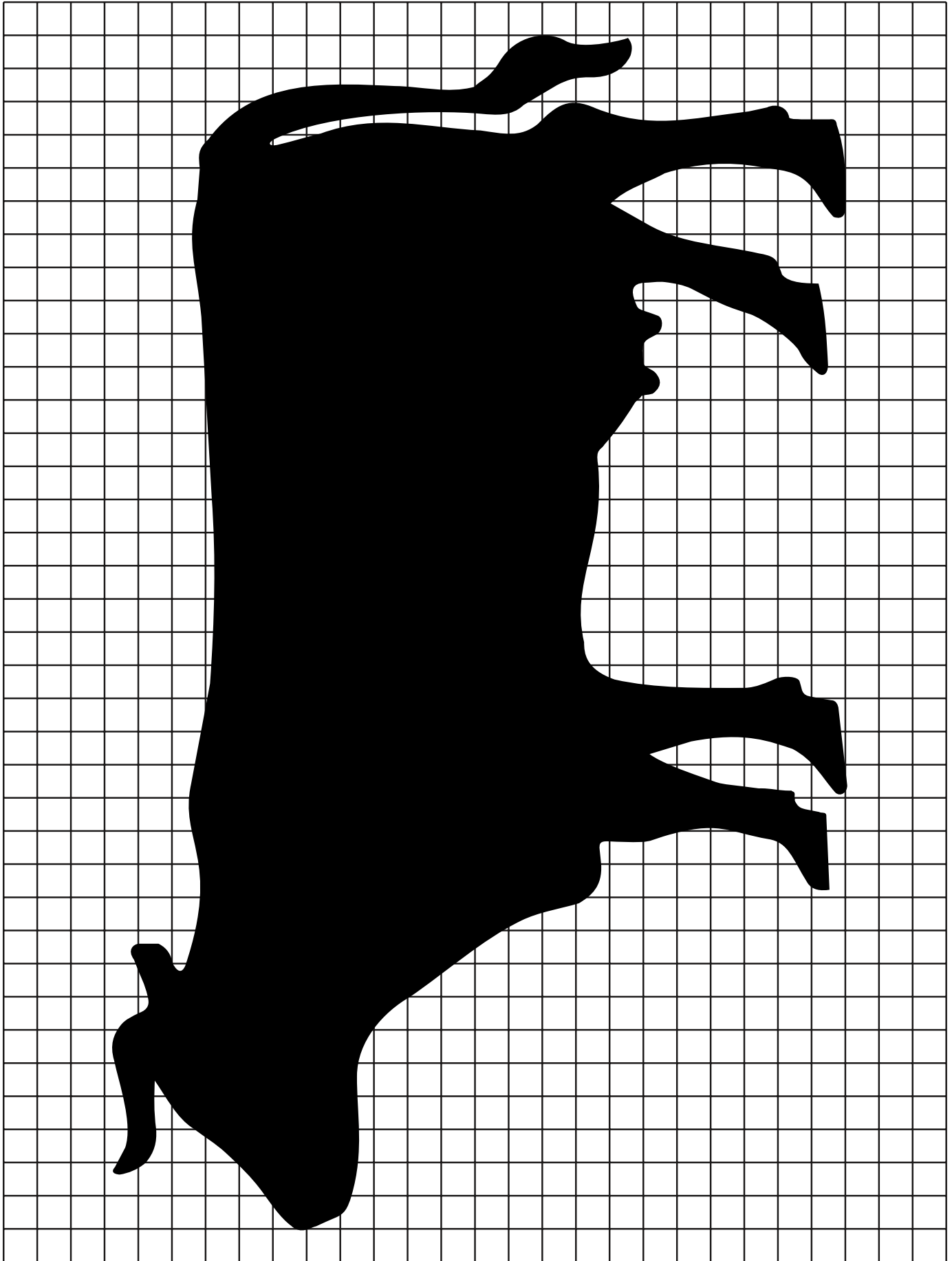

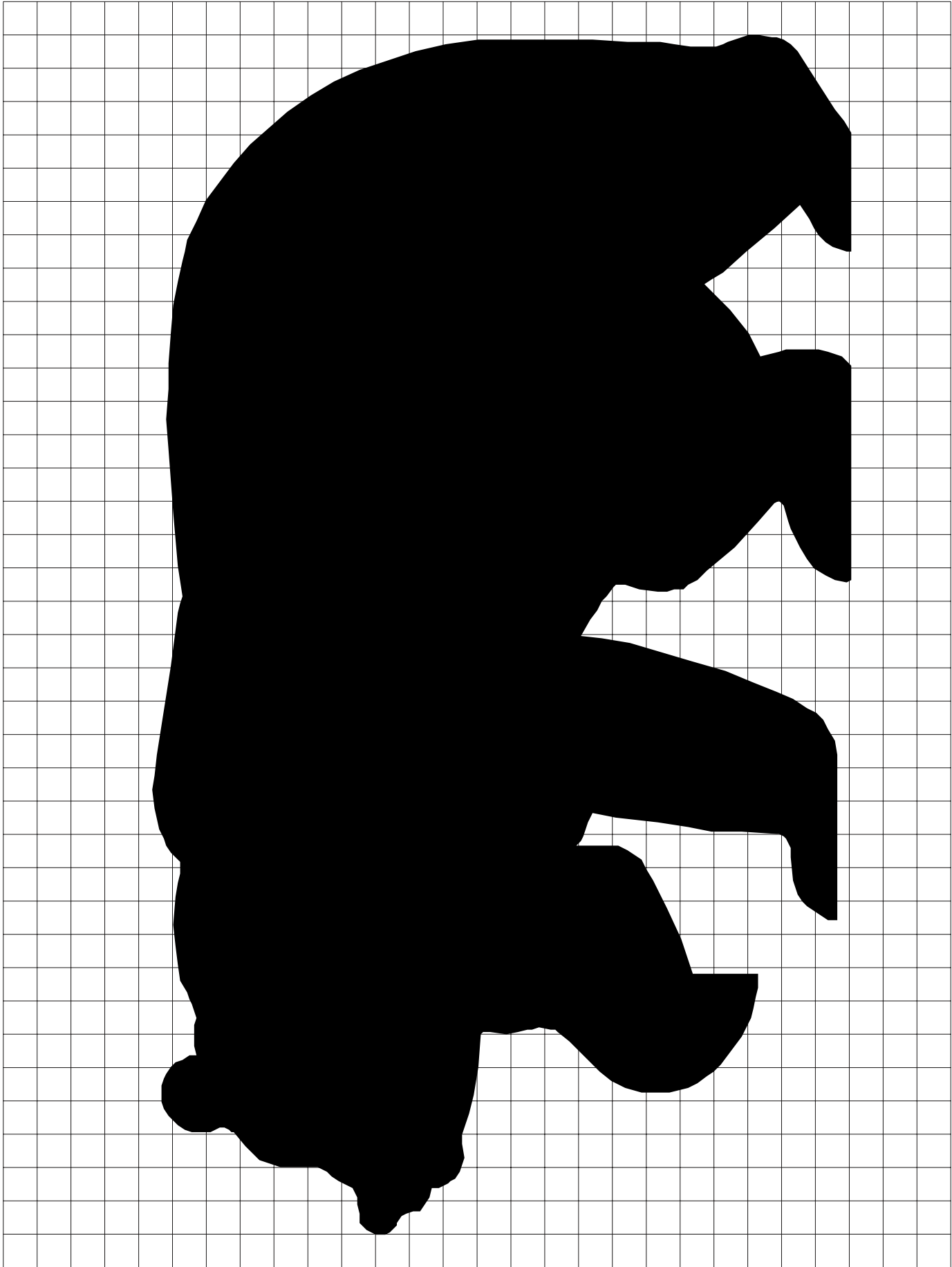

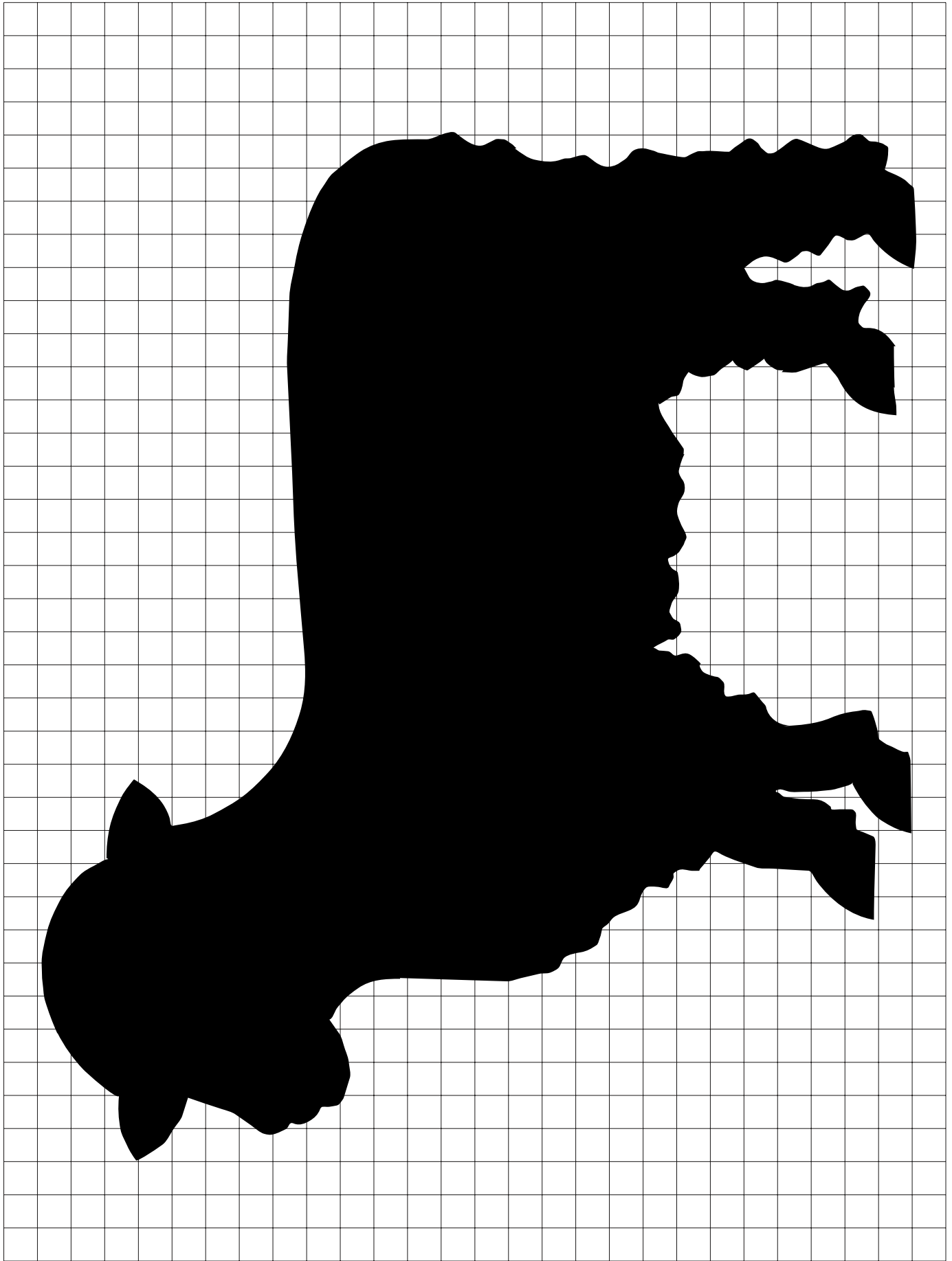

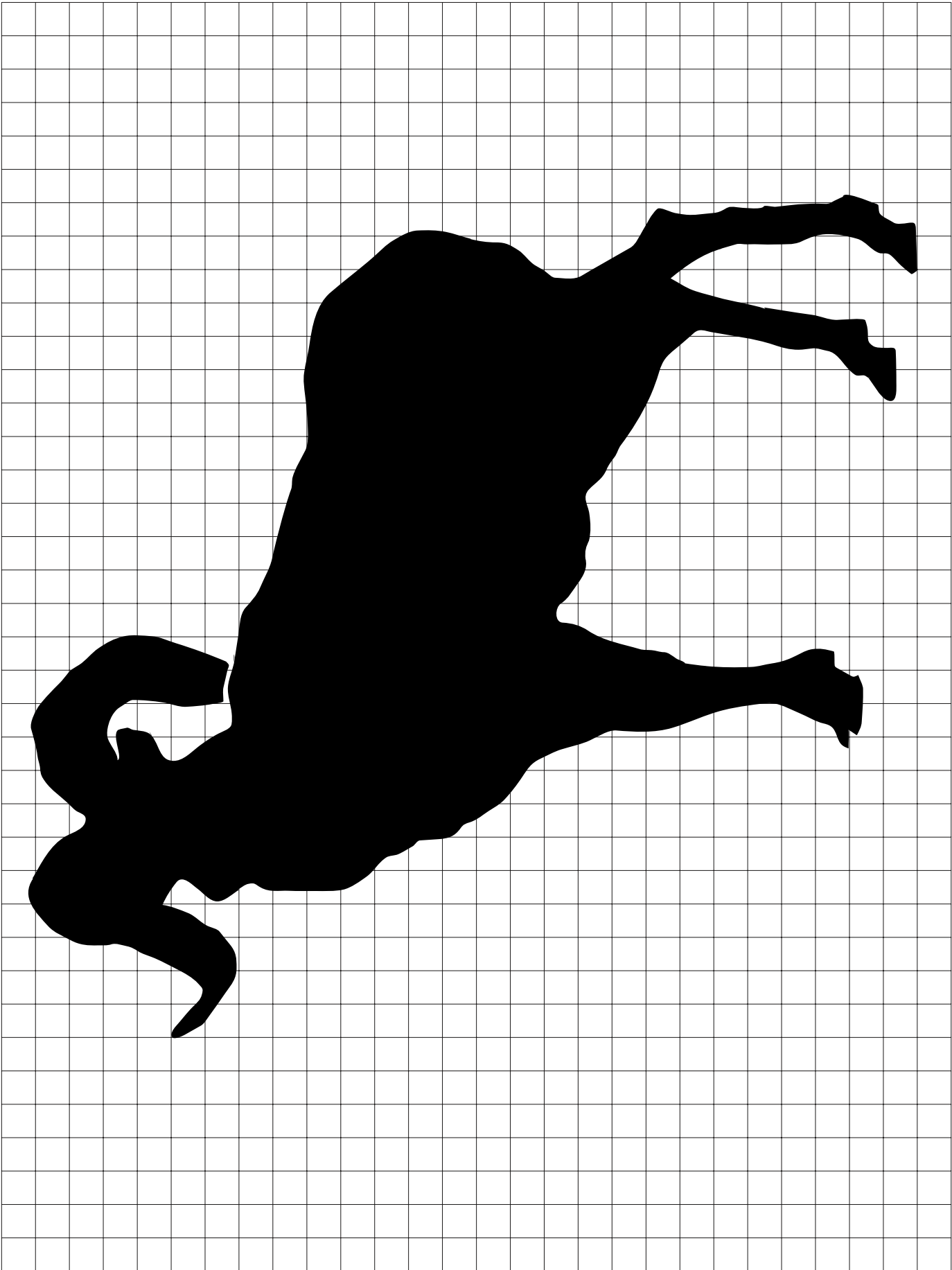

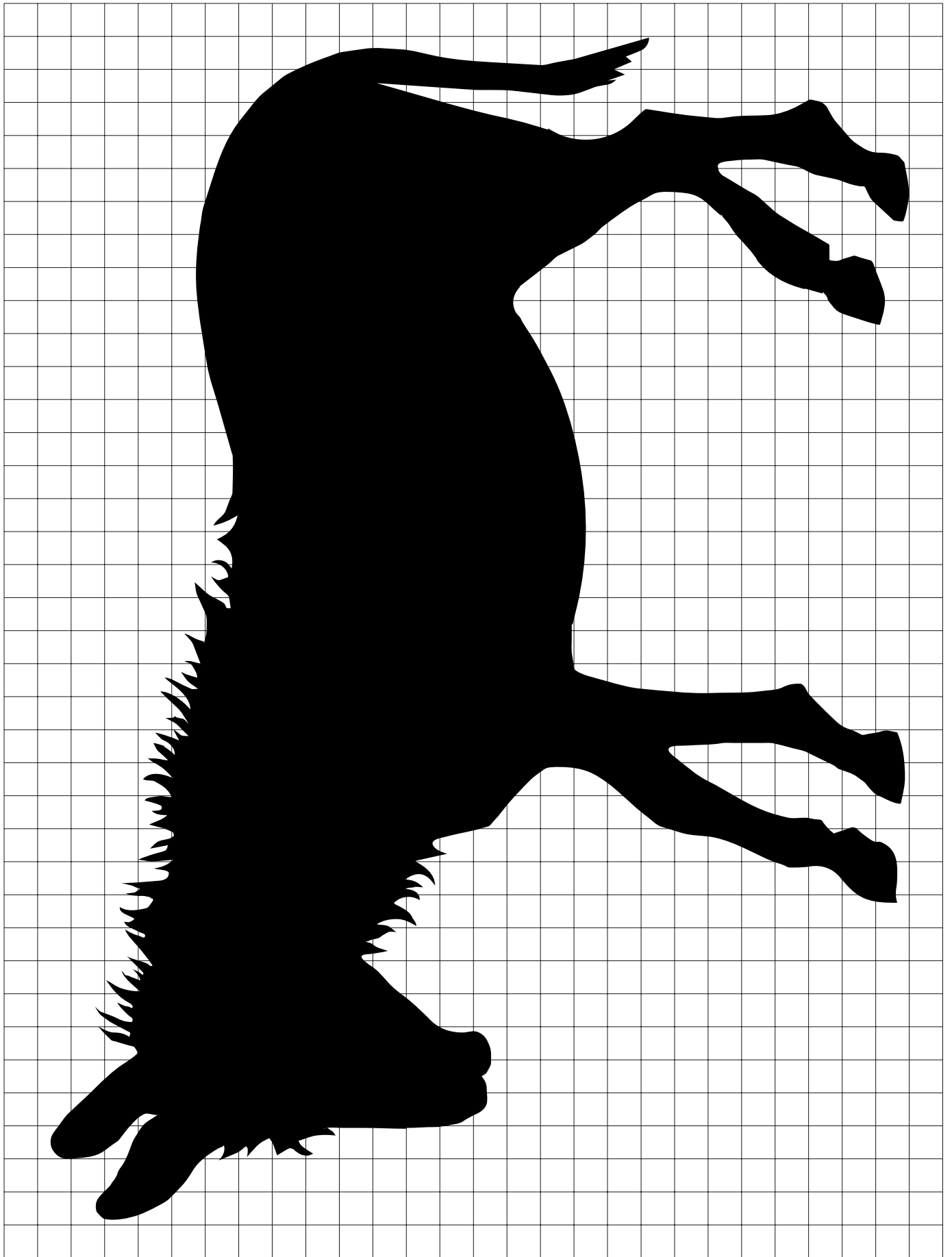

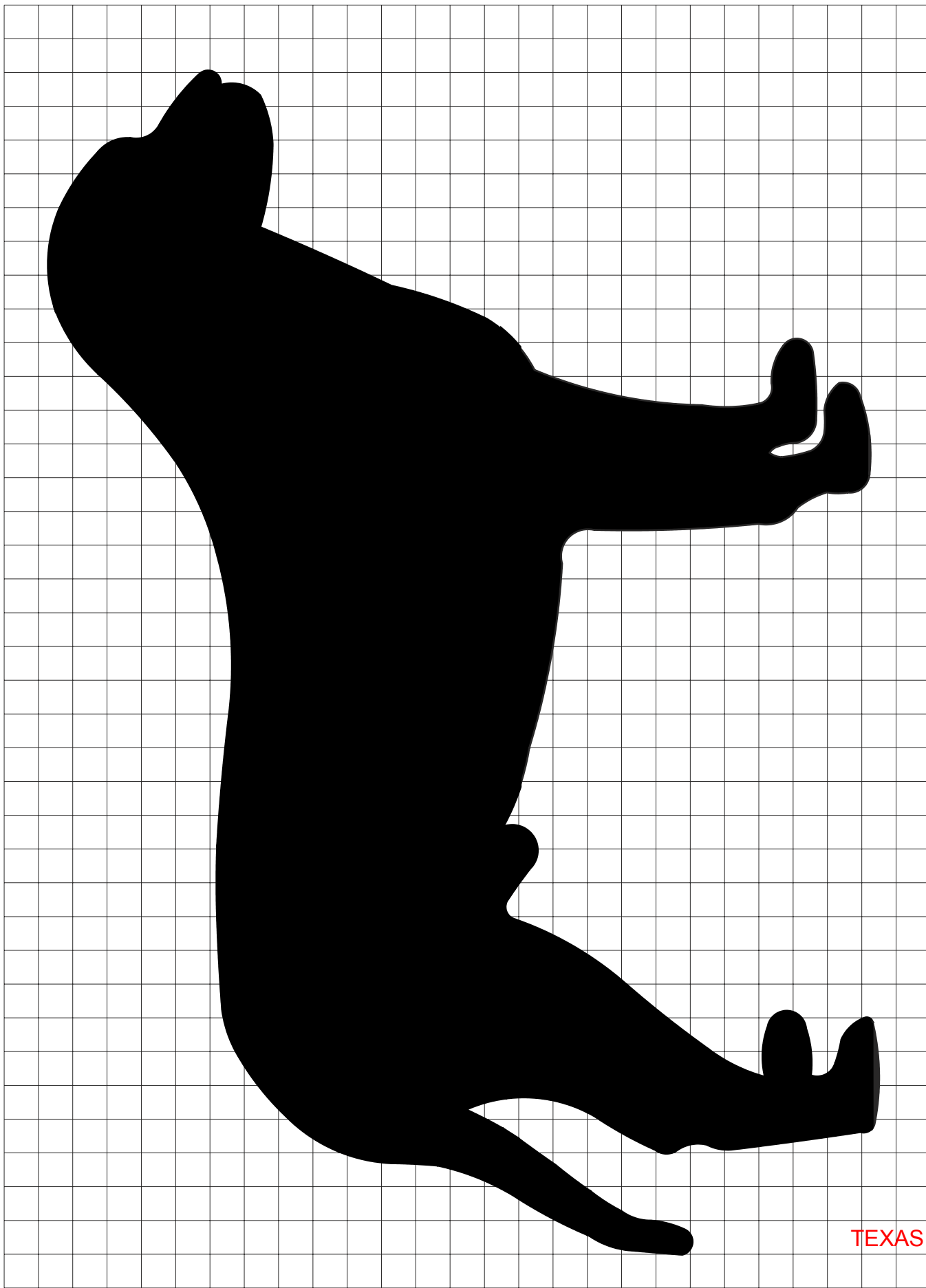

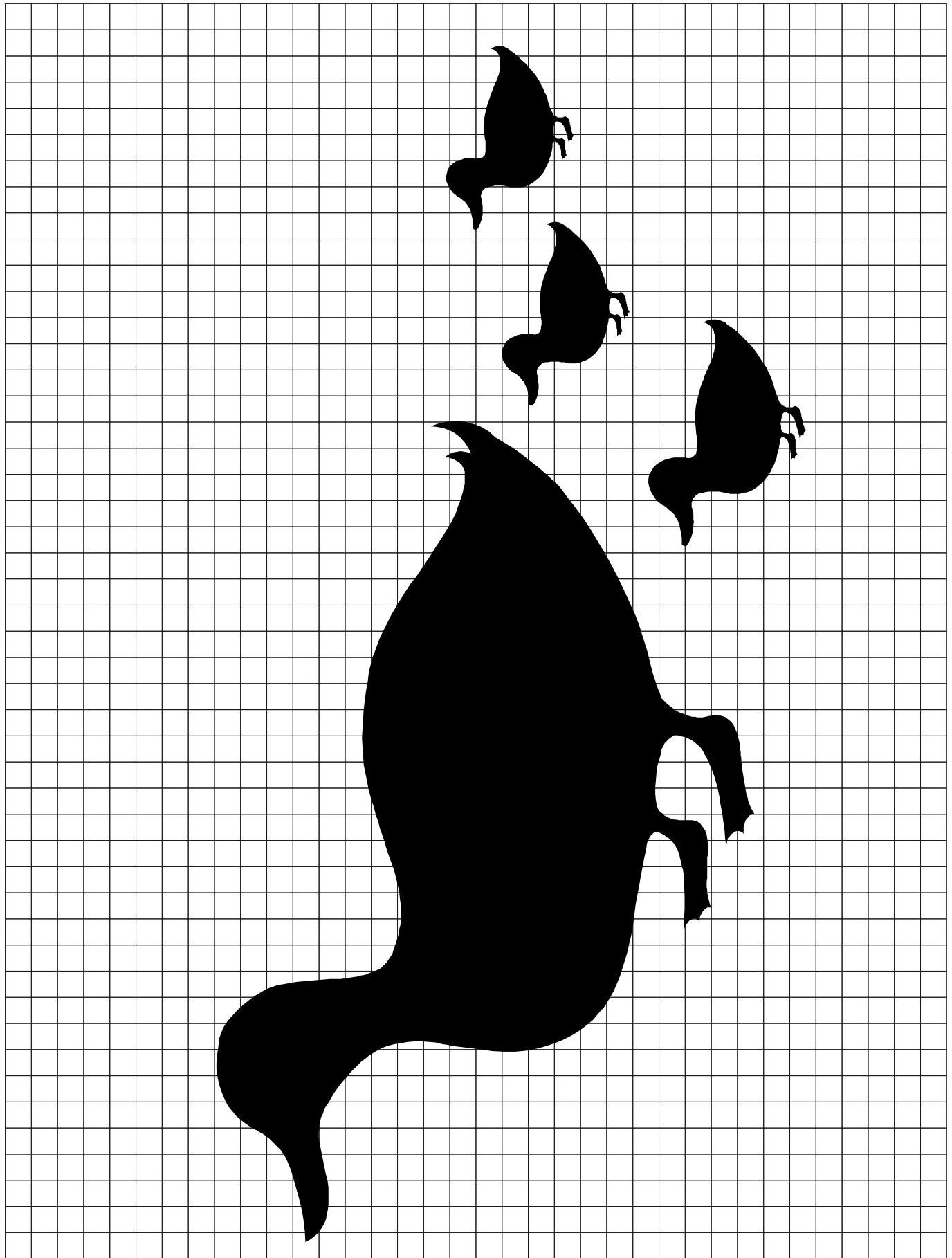

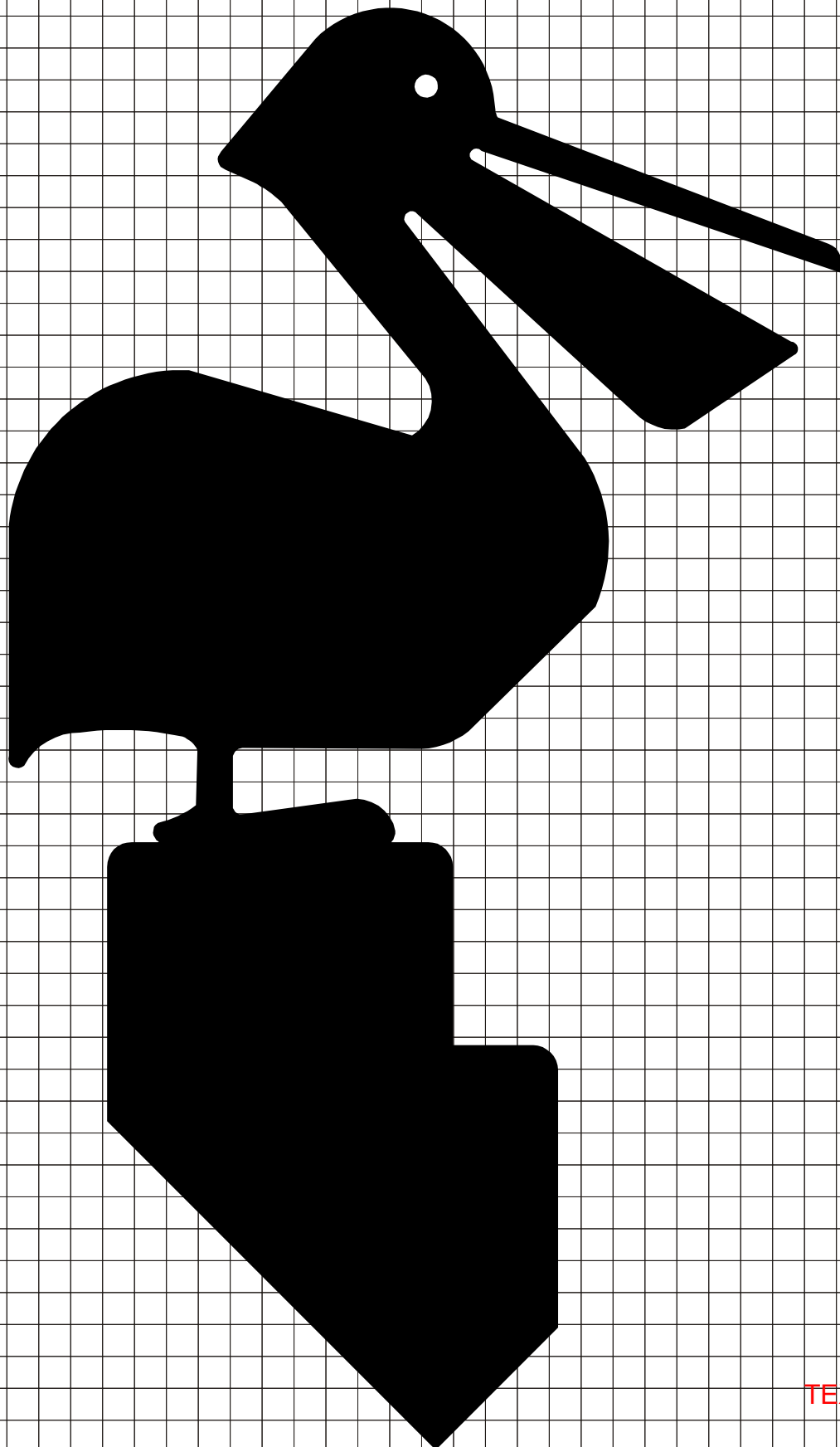

TEXAS

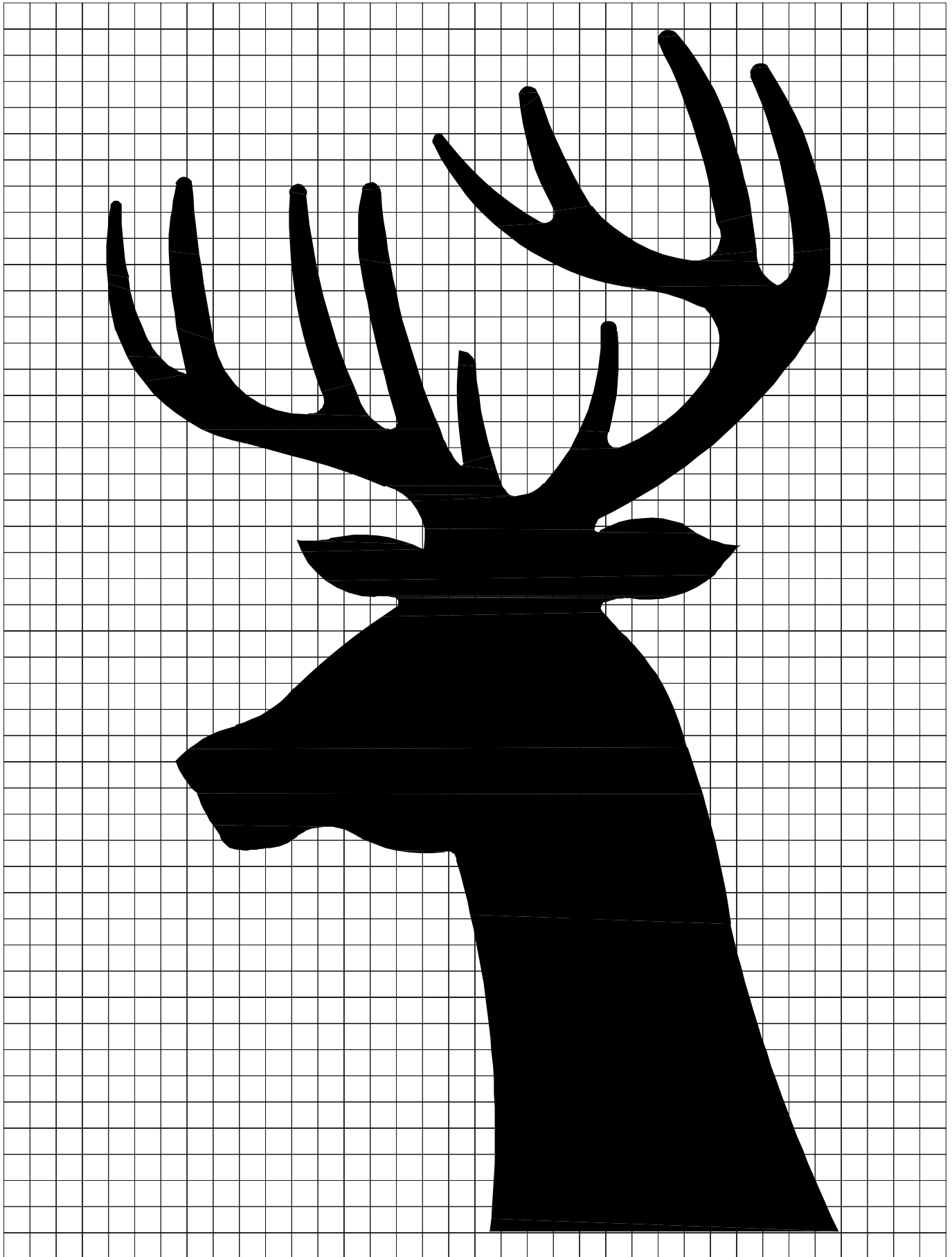

TEXAS

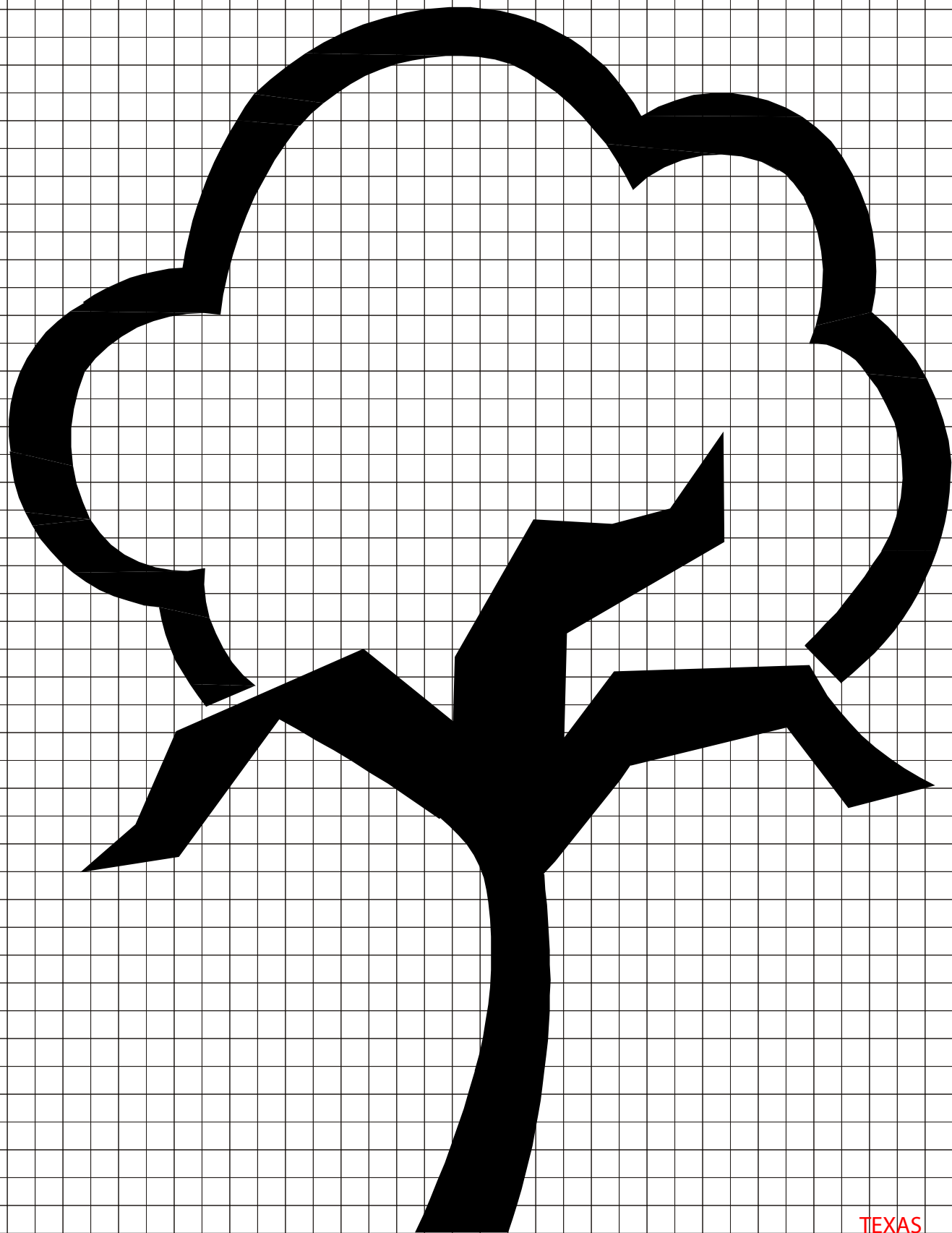

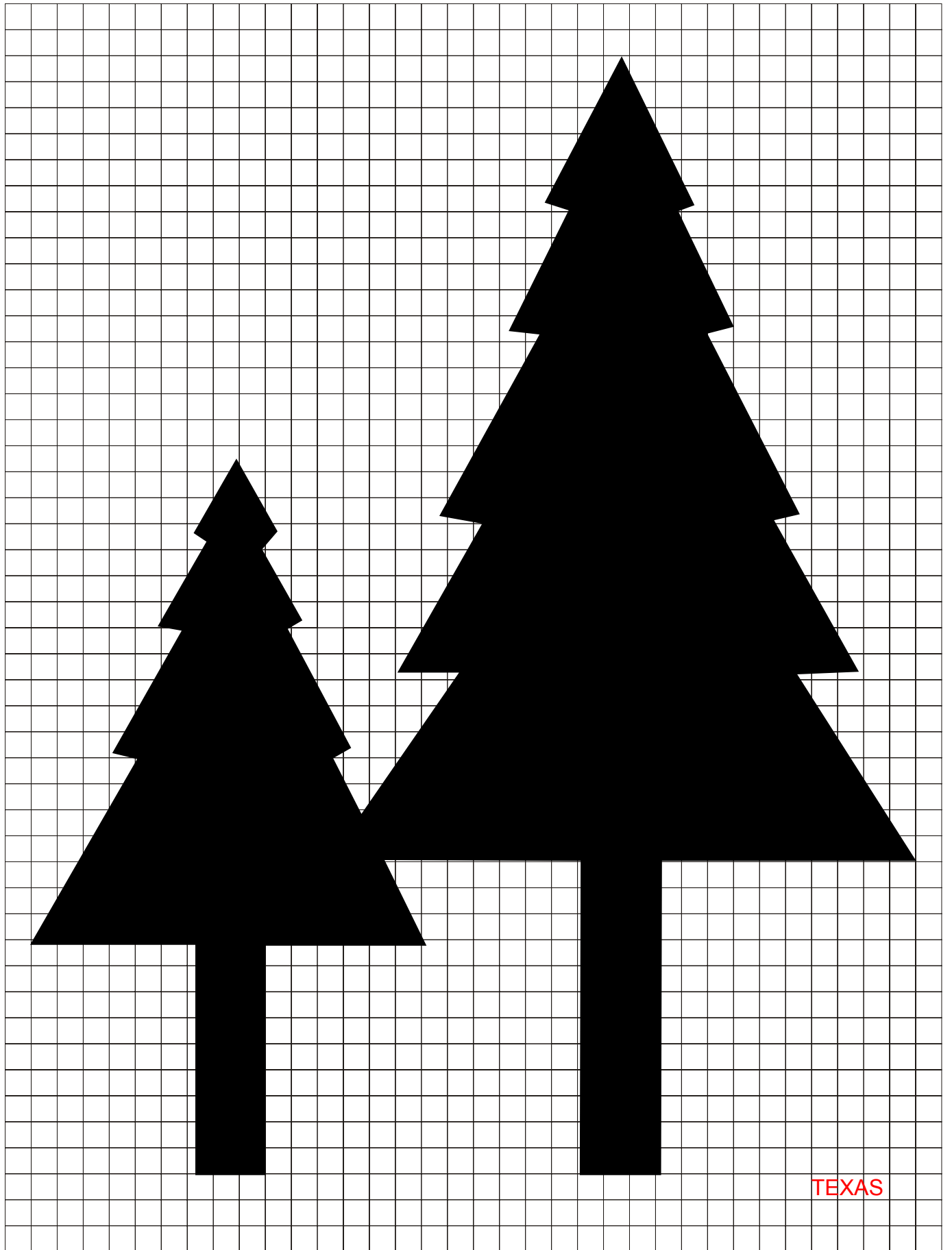

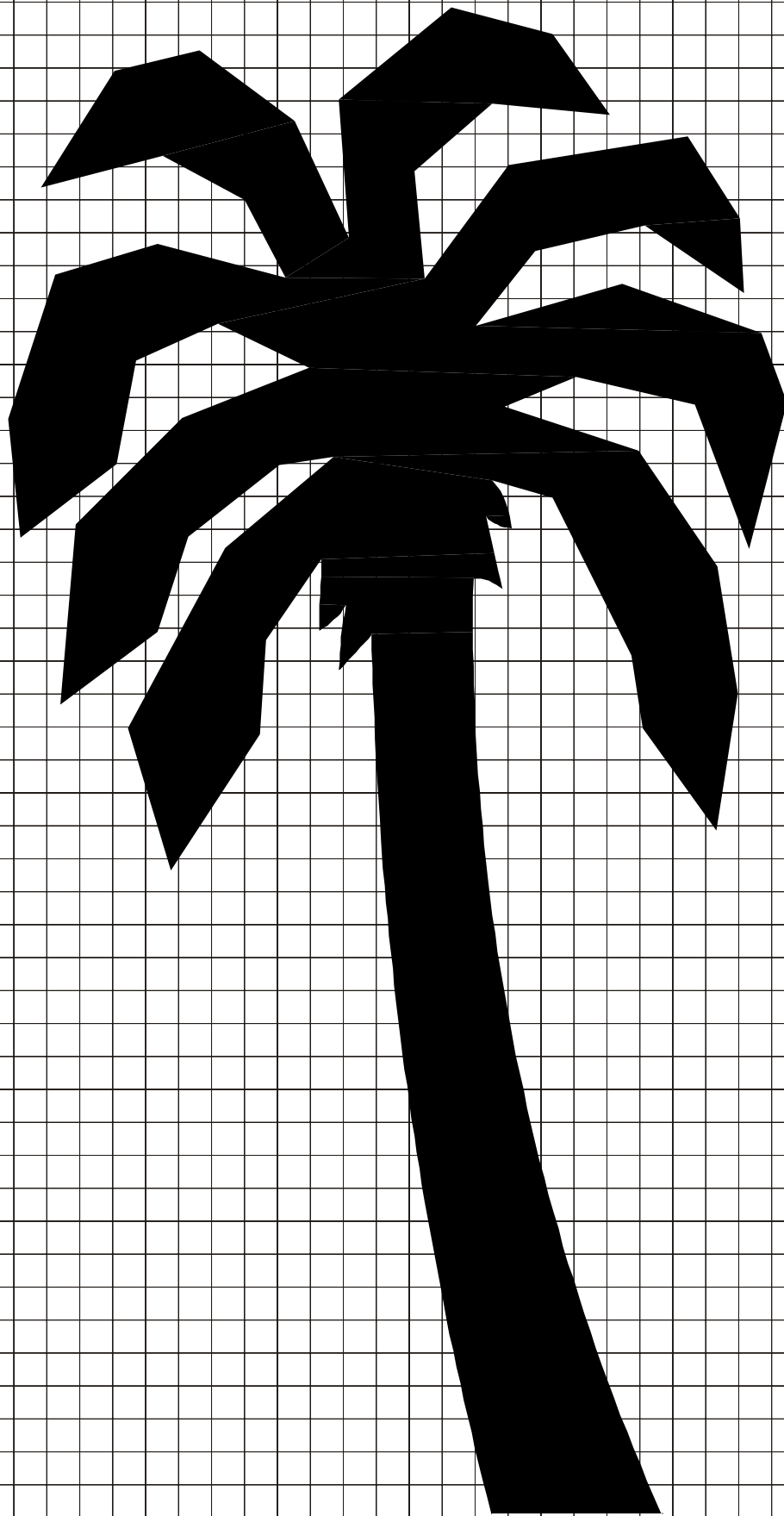

TEXAS

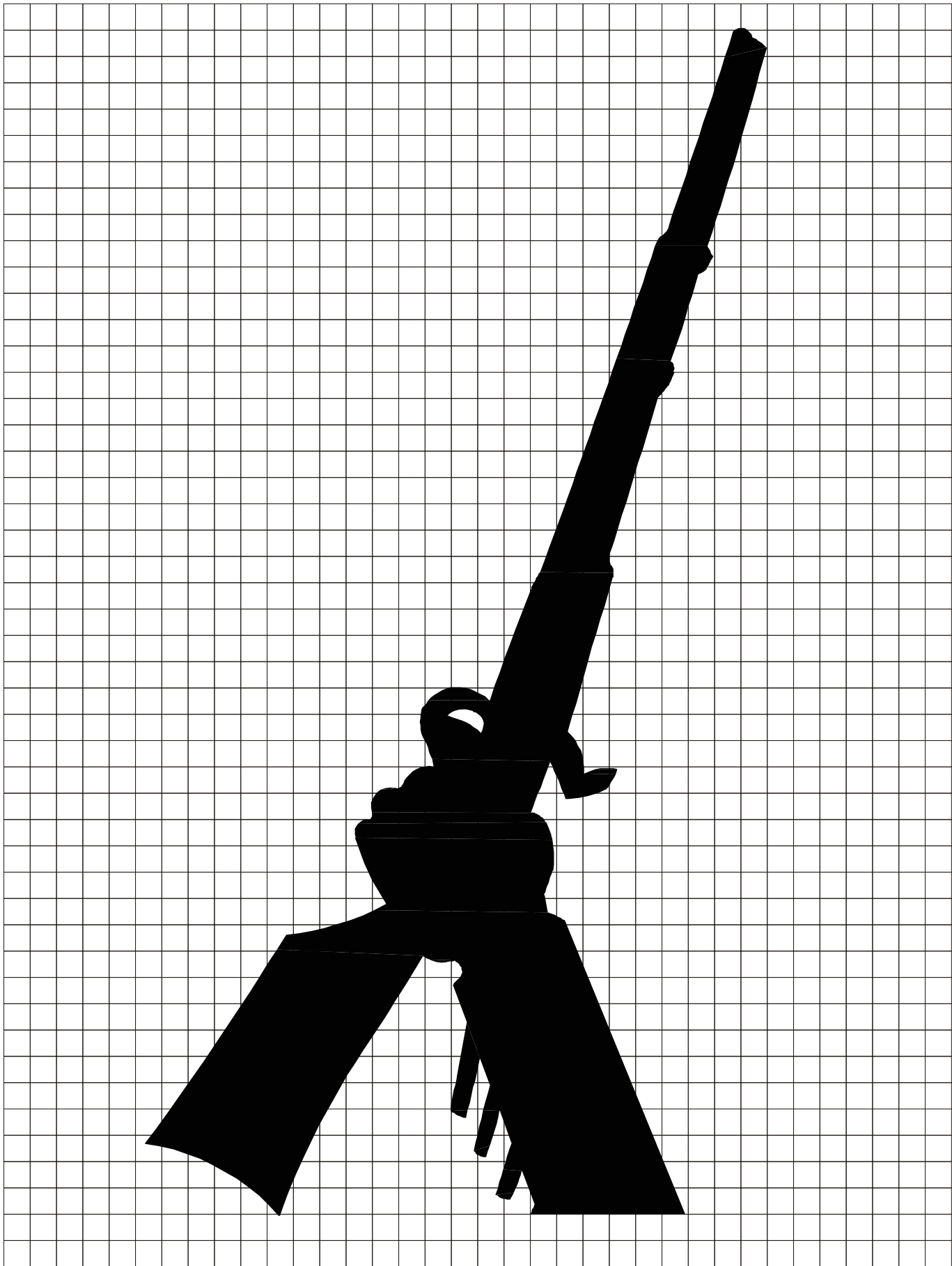

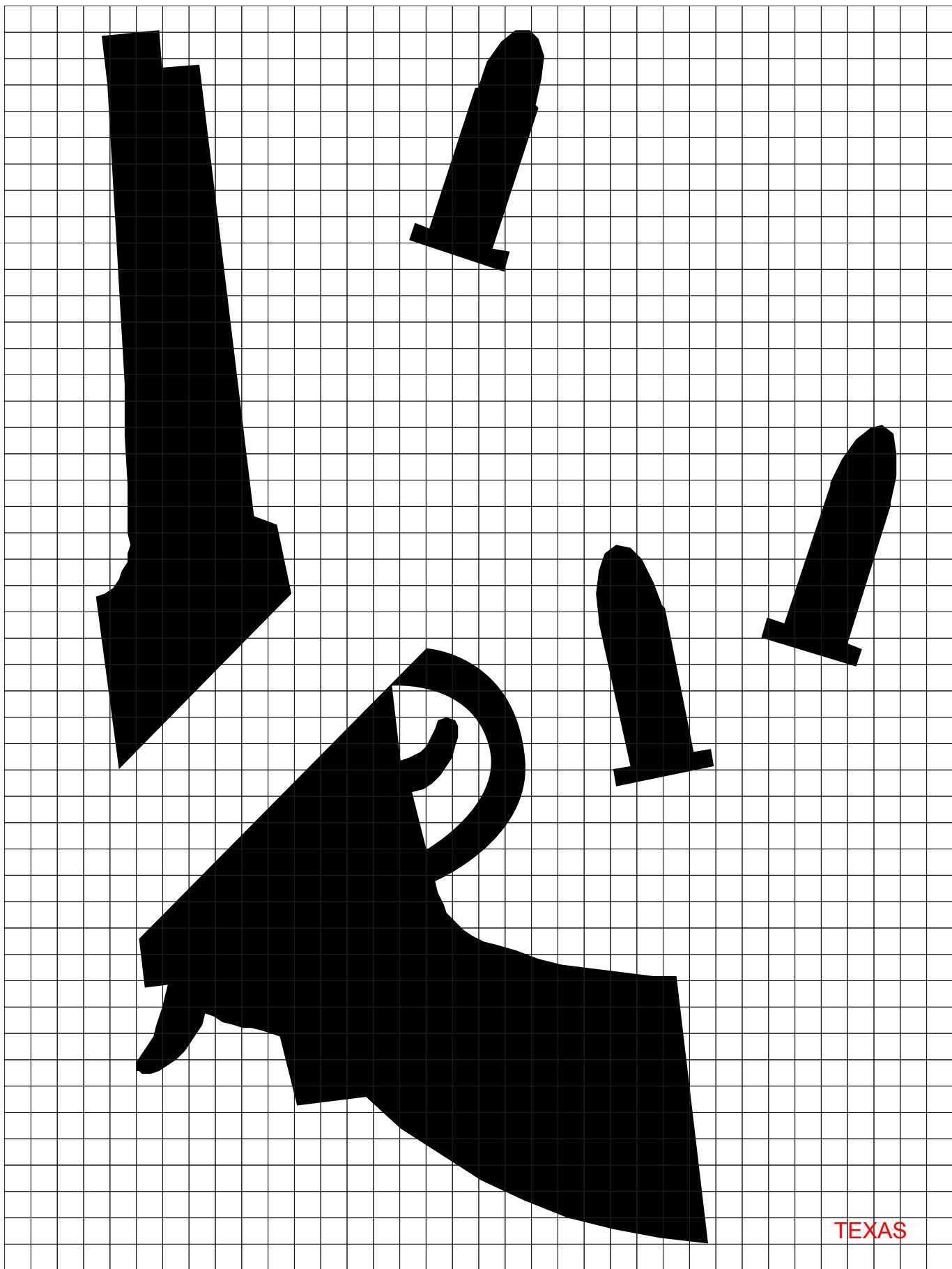

TEXAS

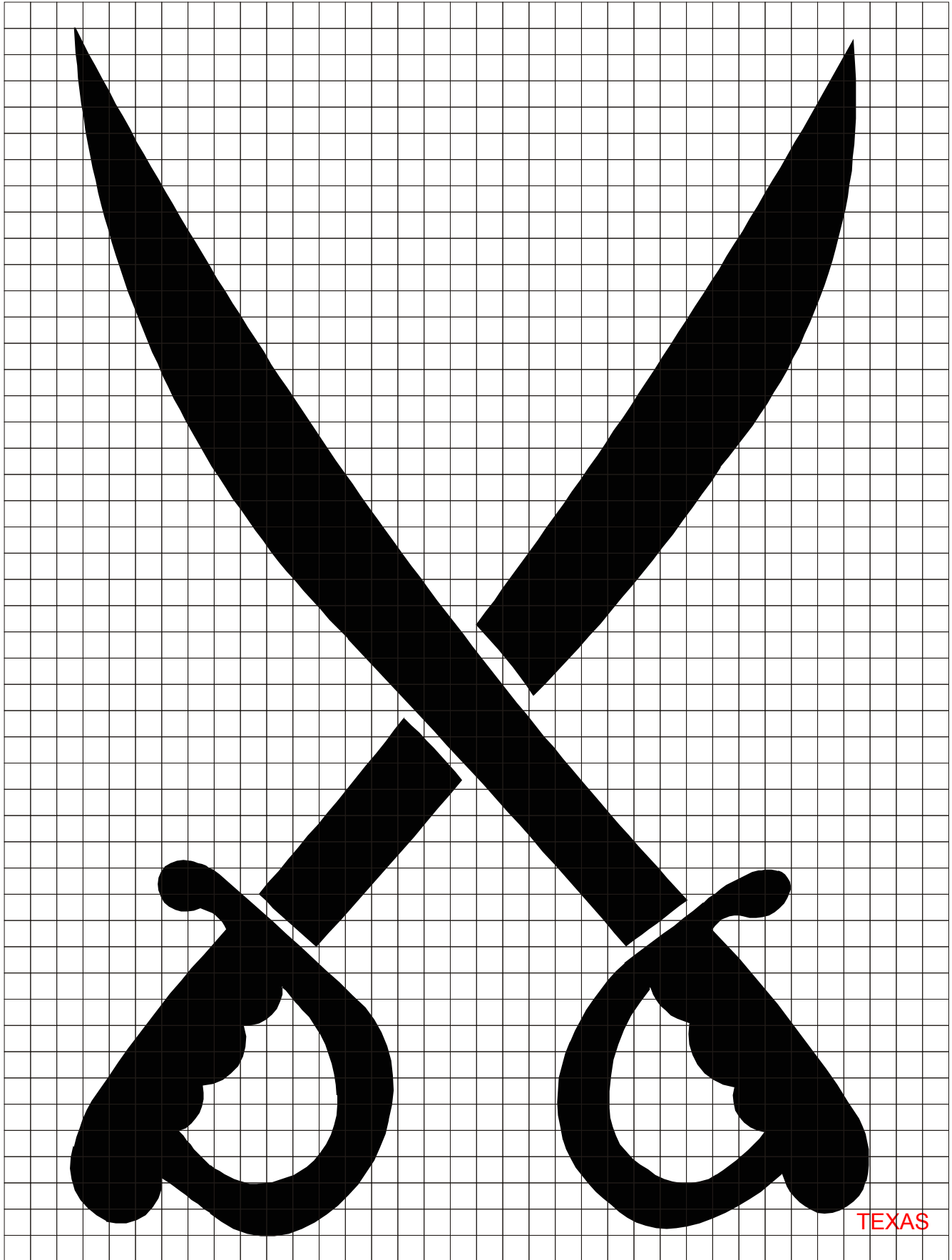

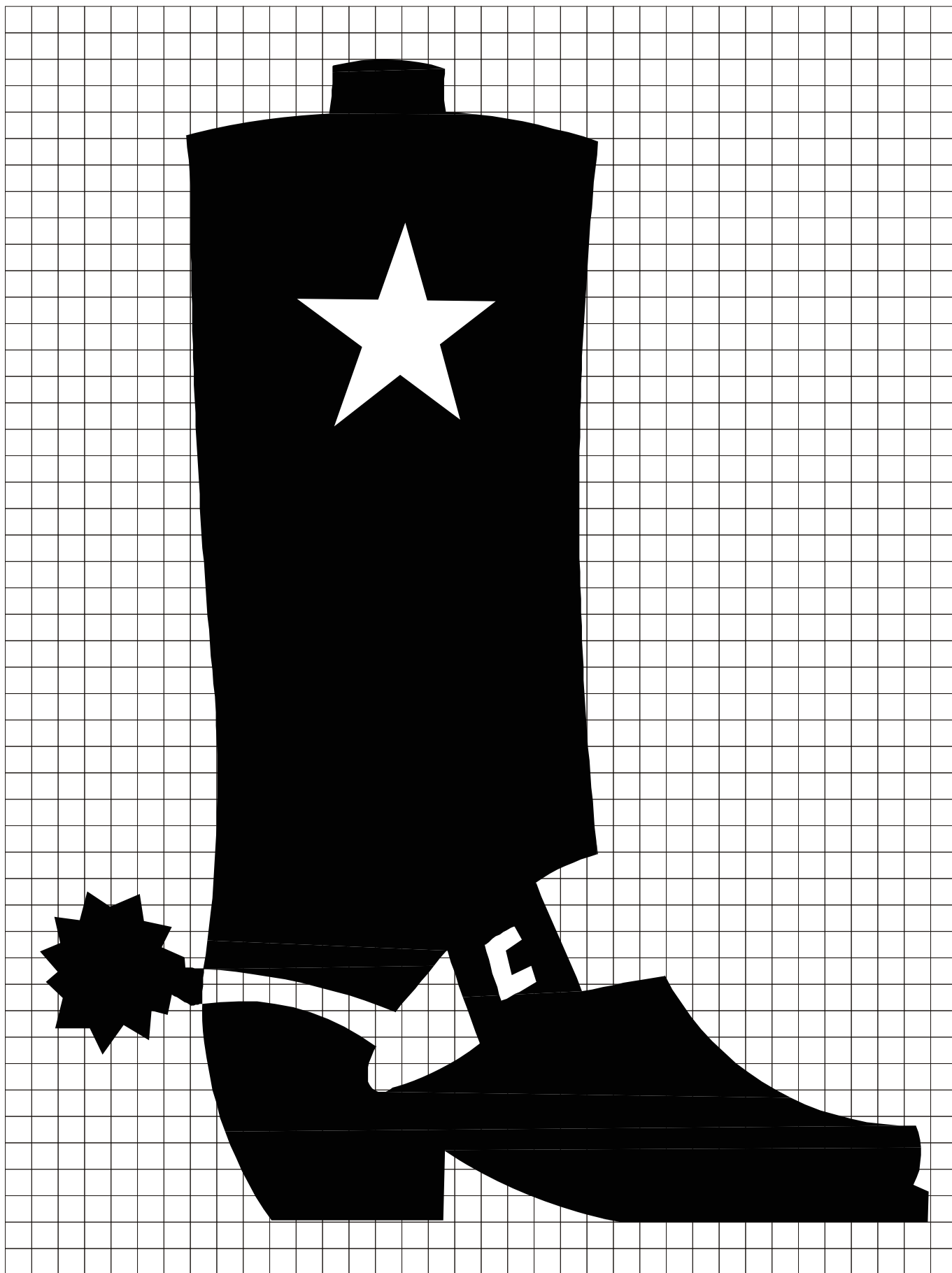

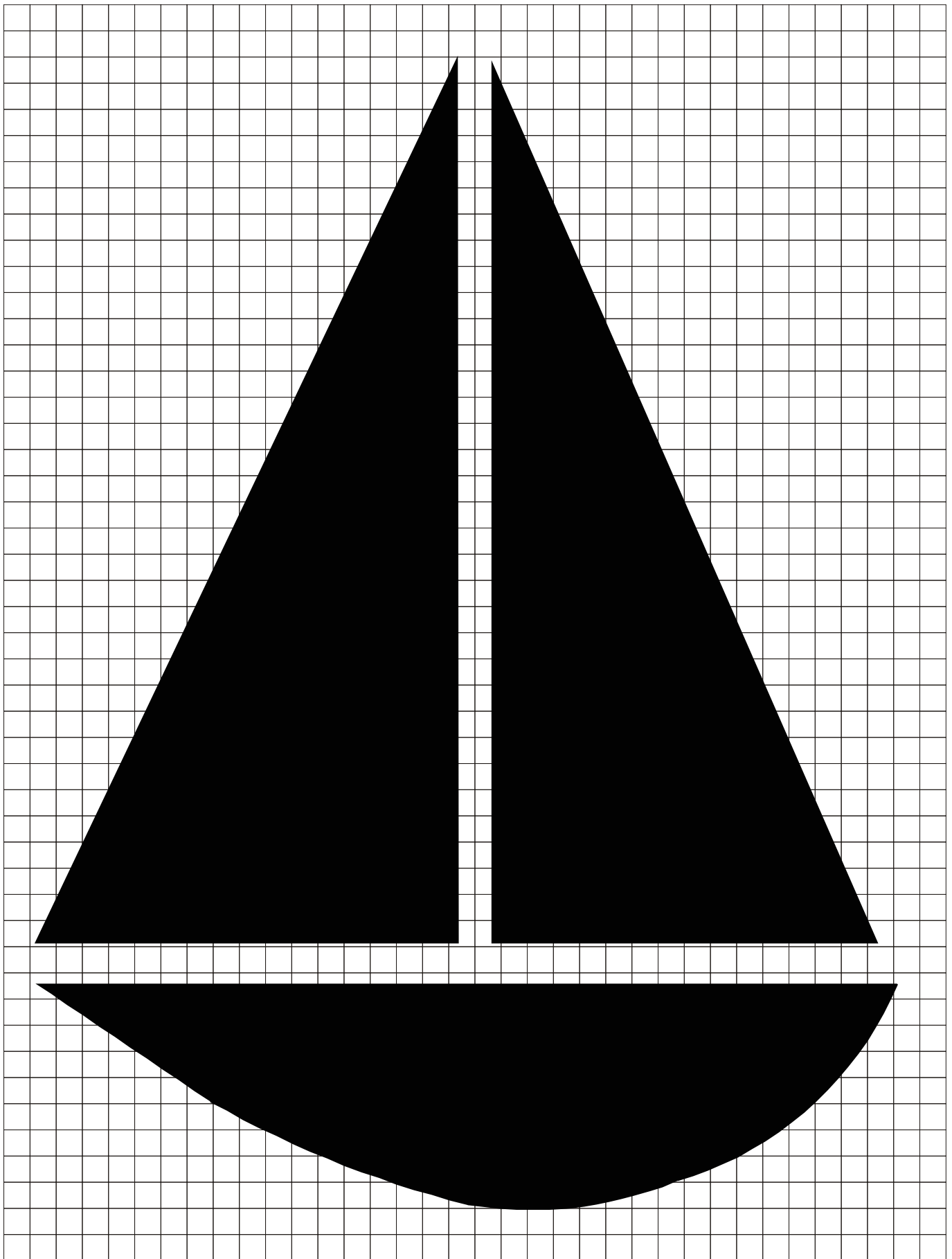

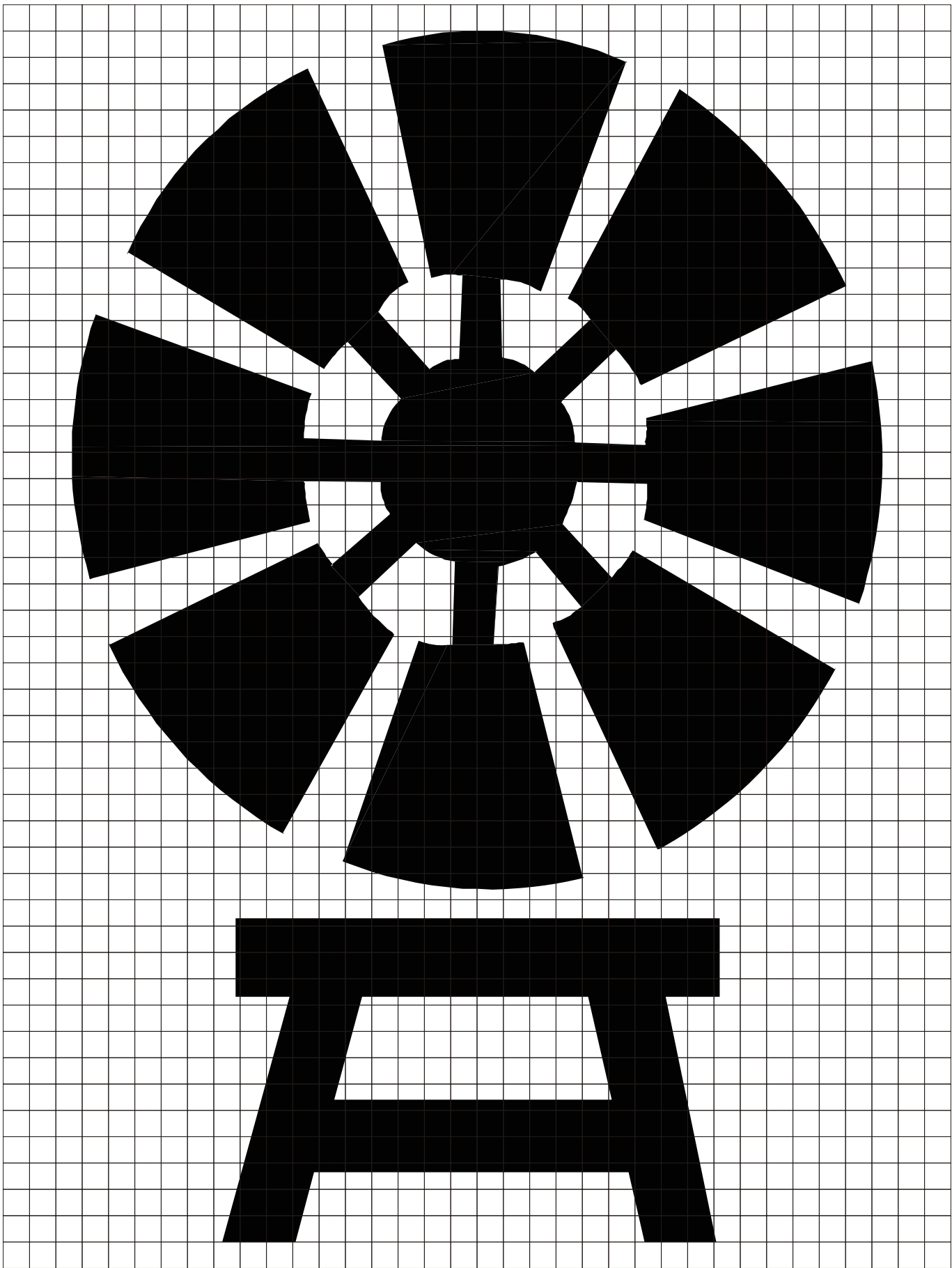

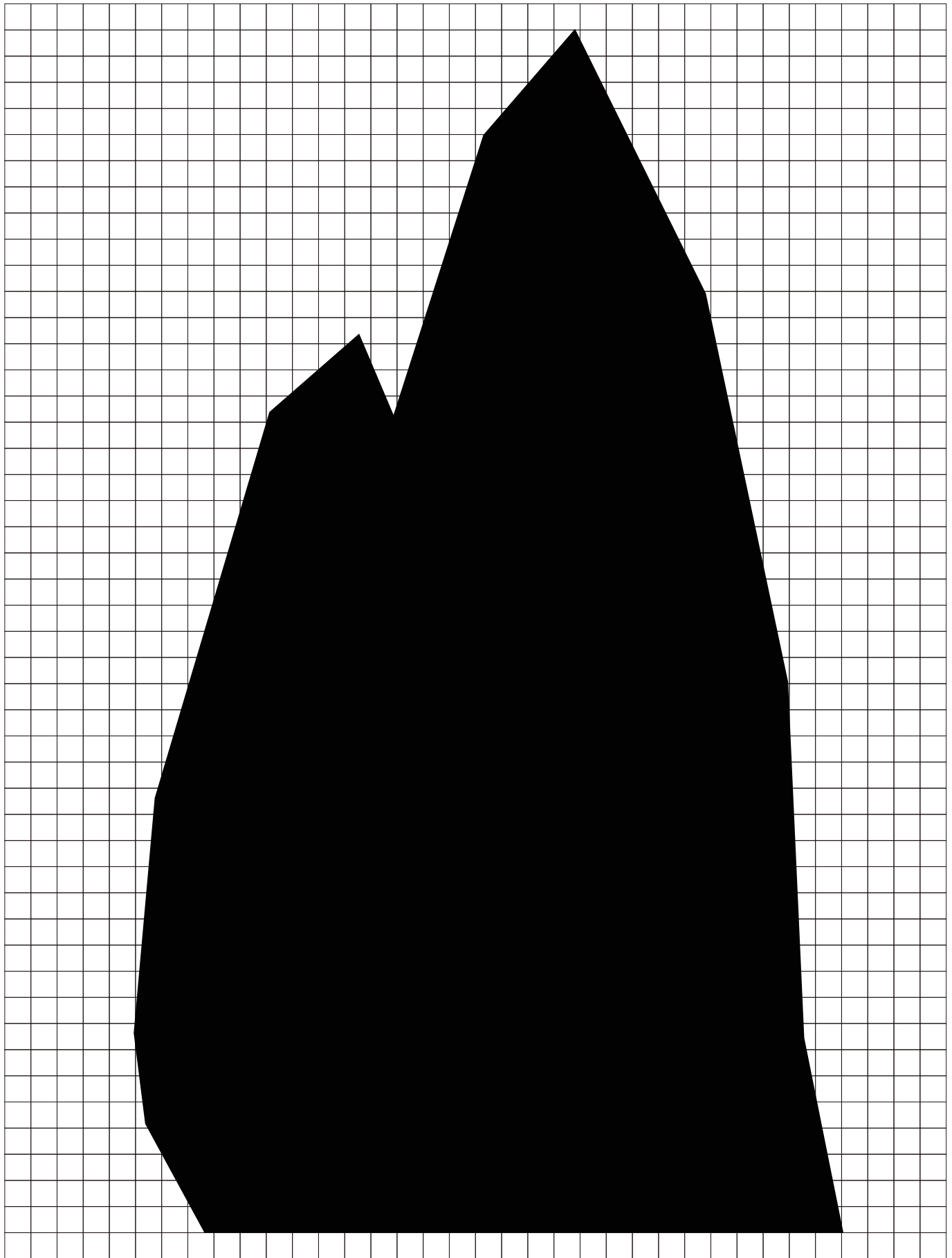

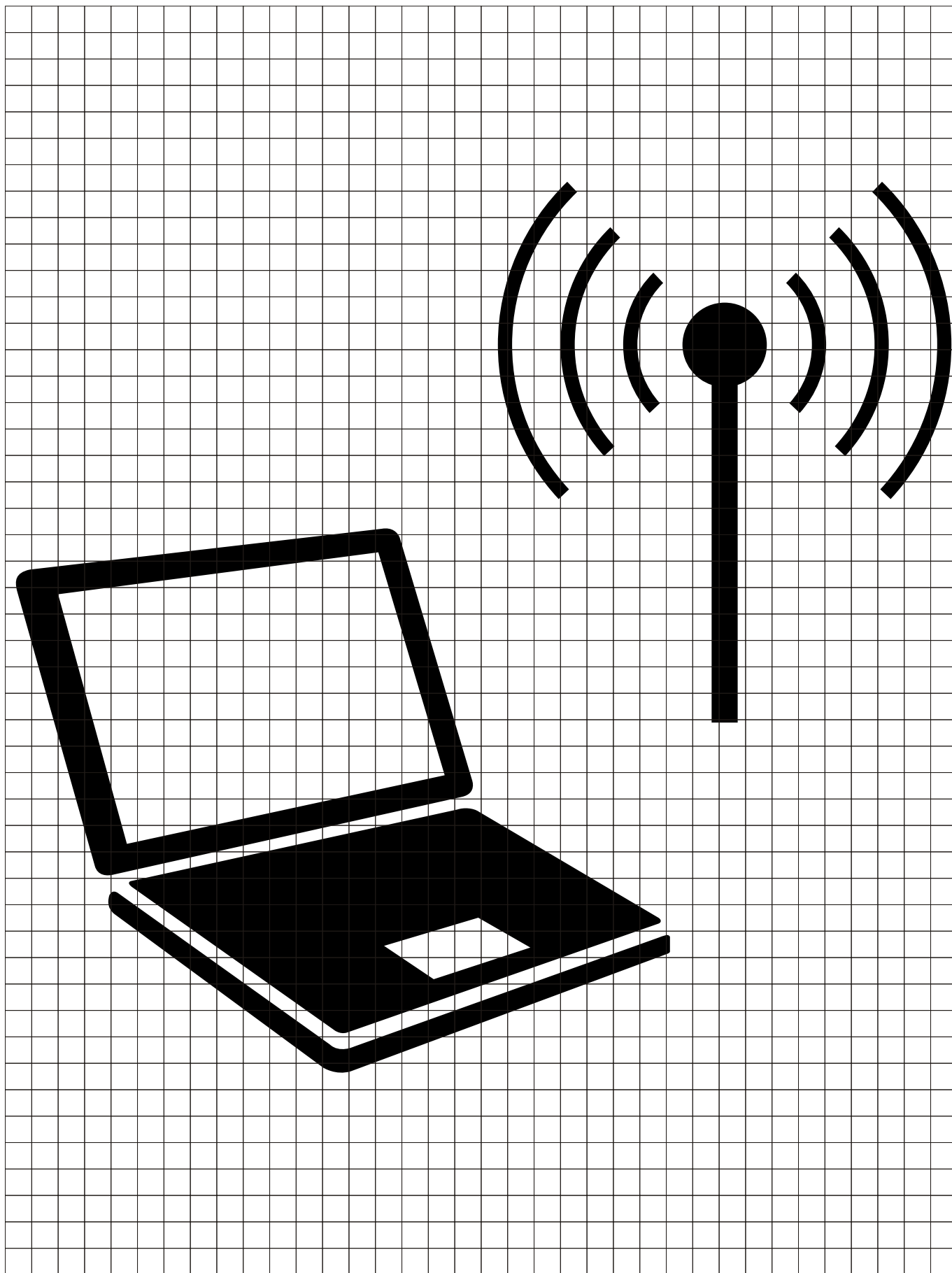

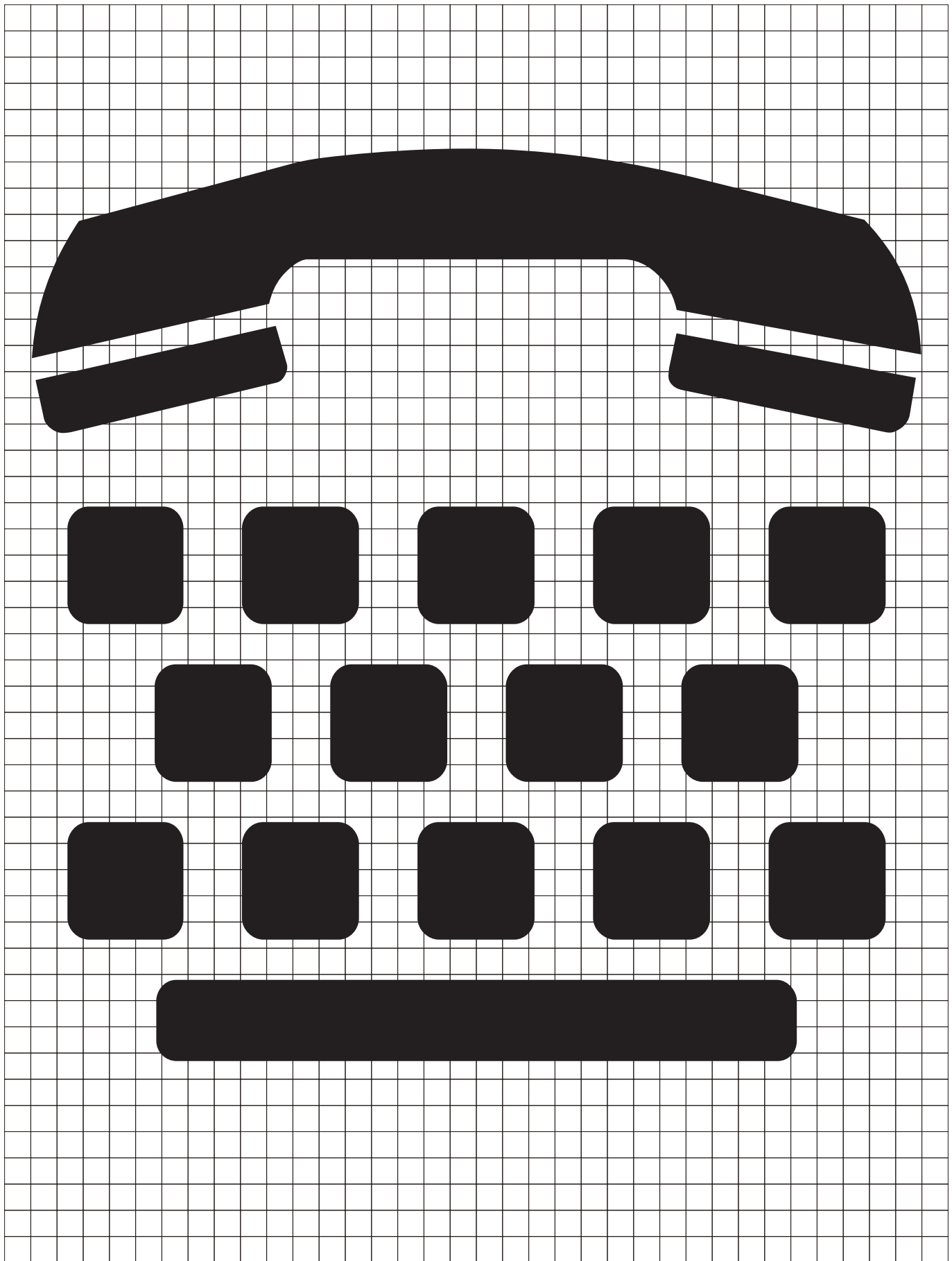

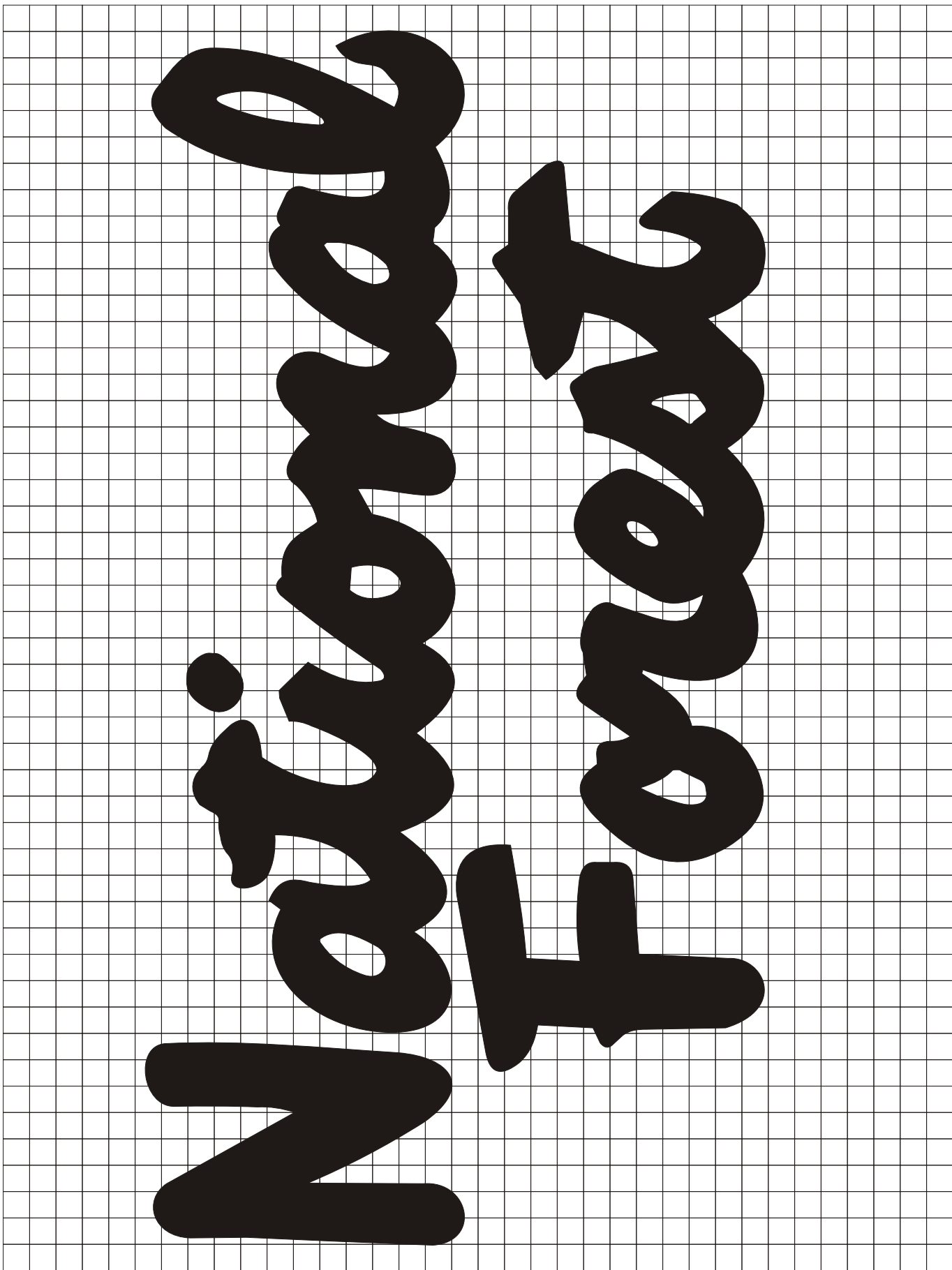



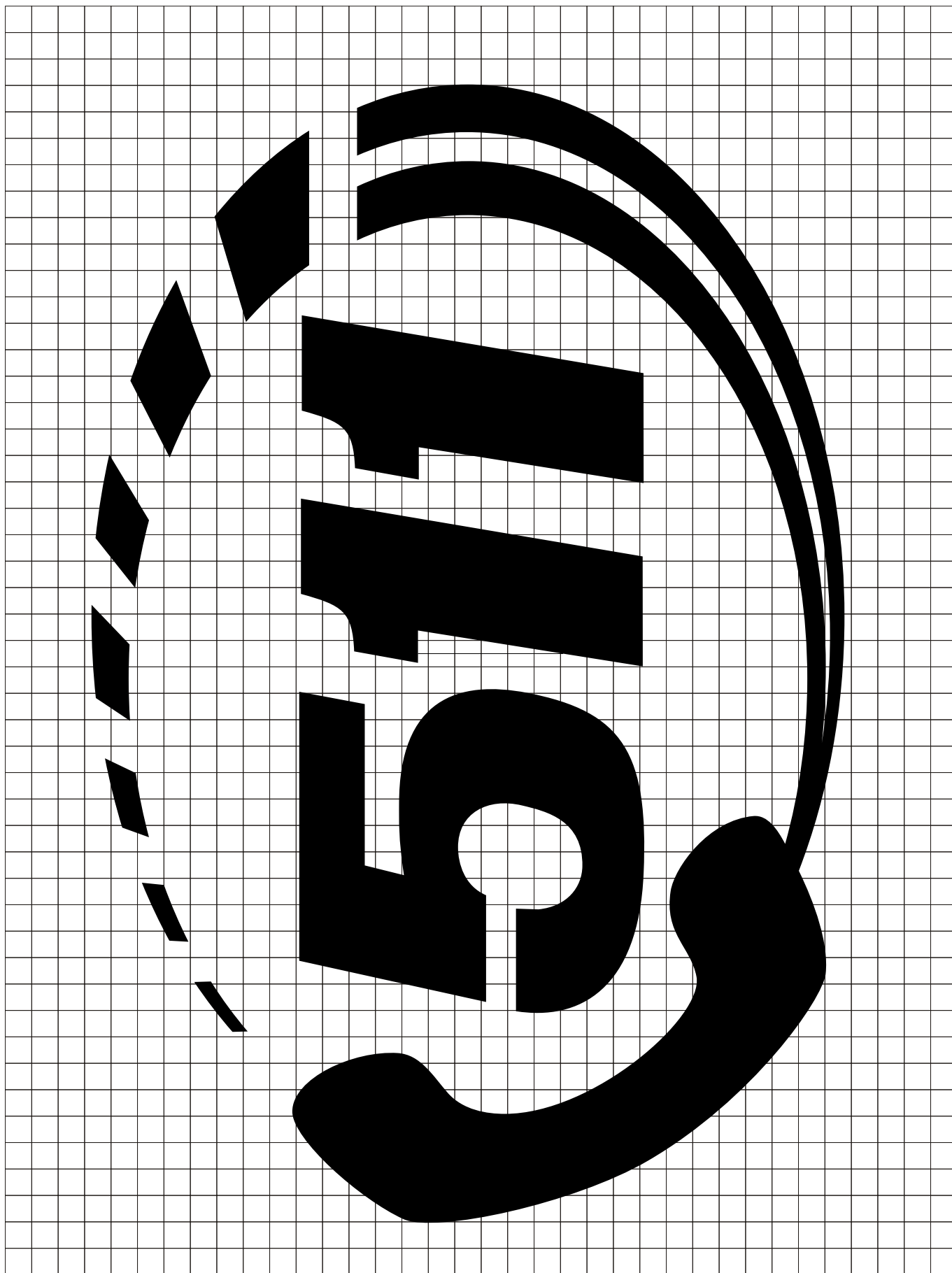

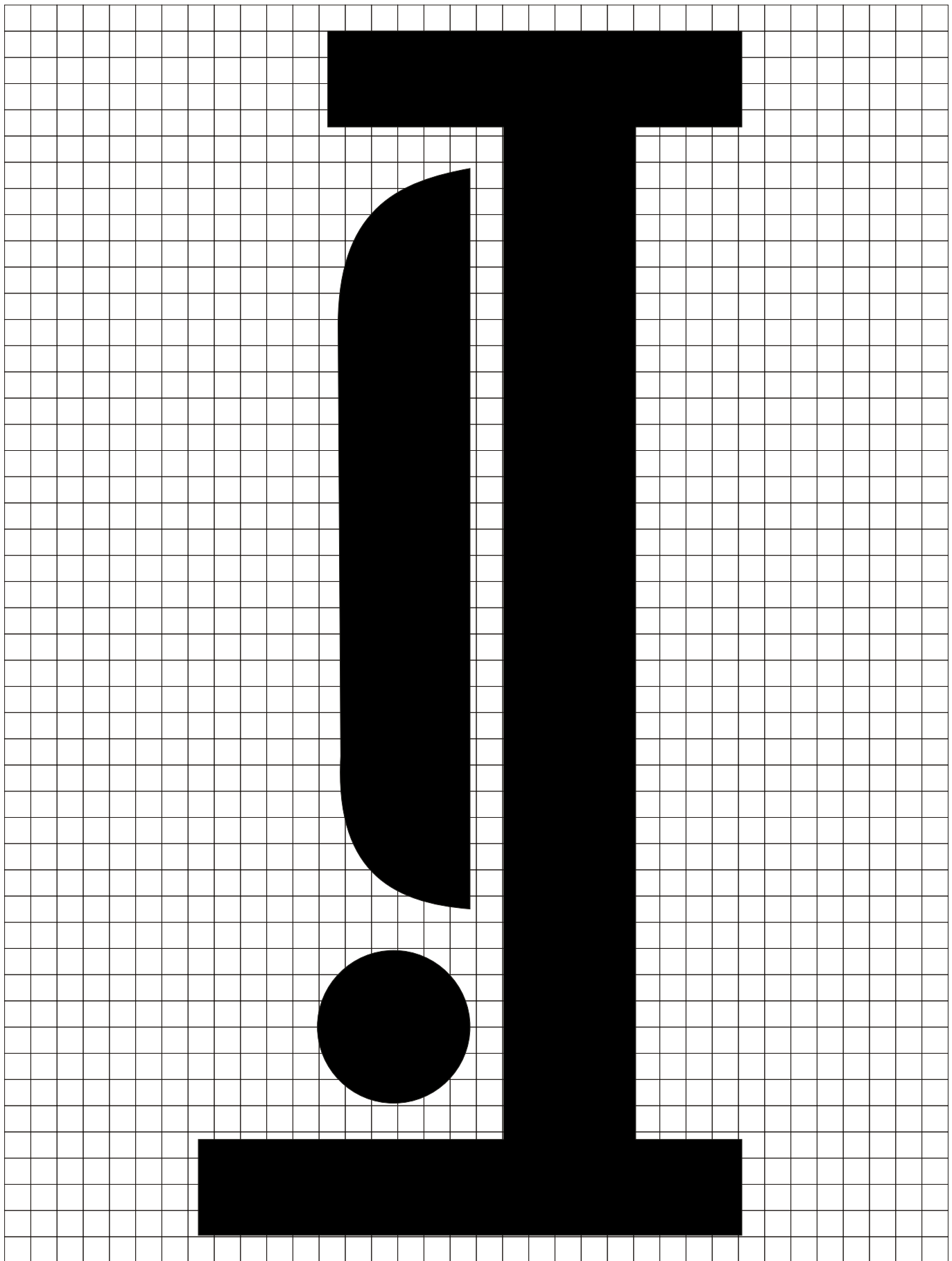

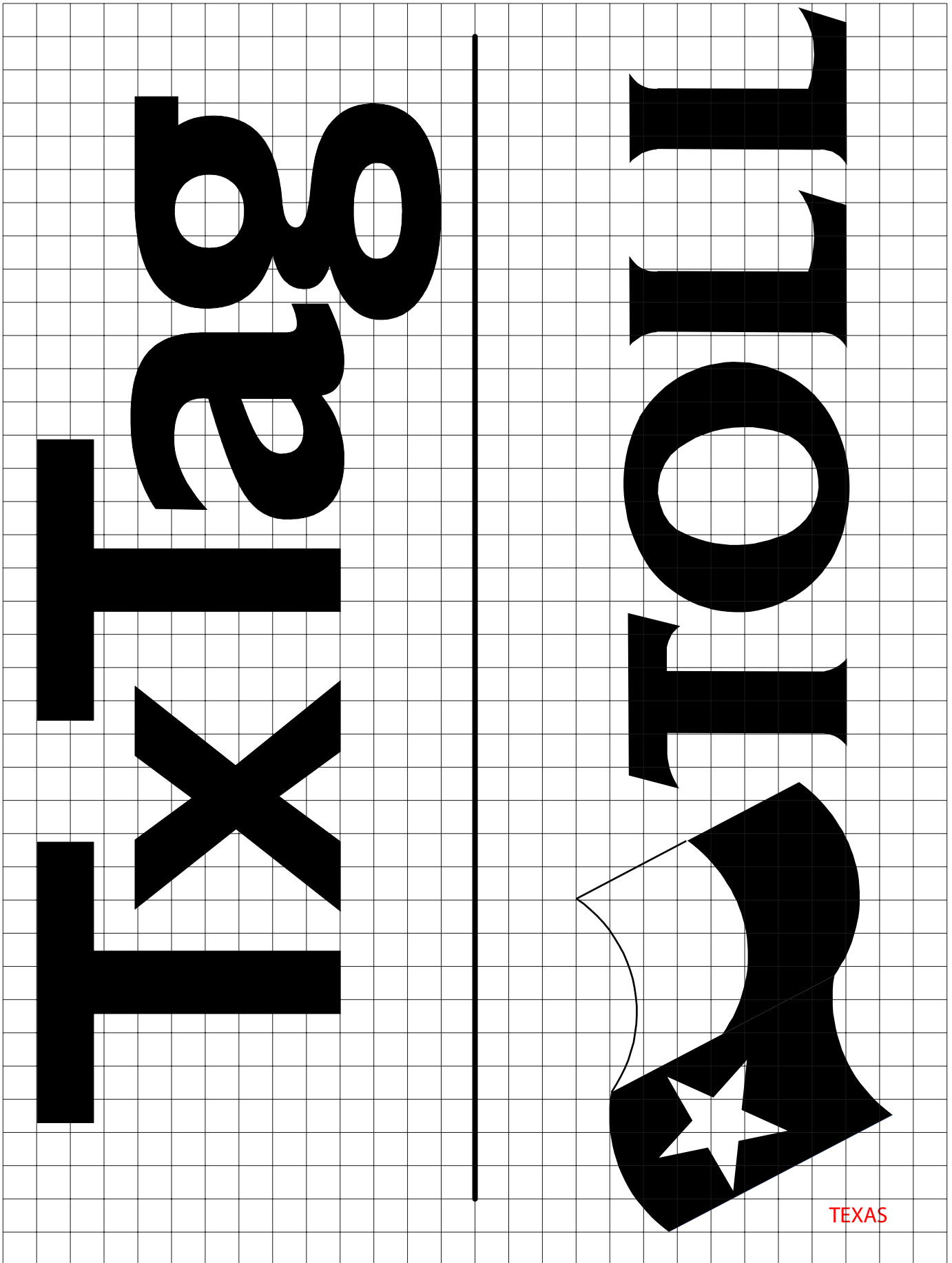

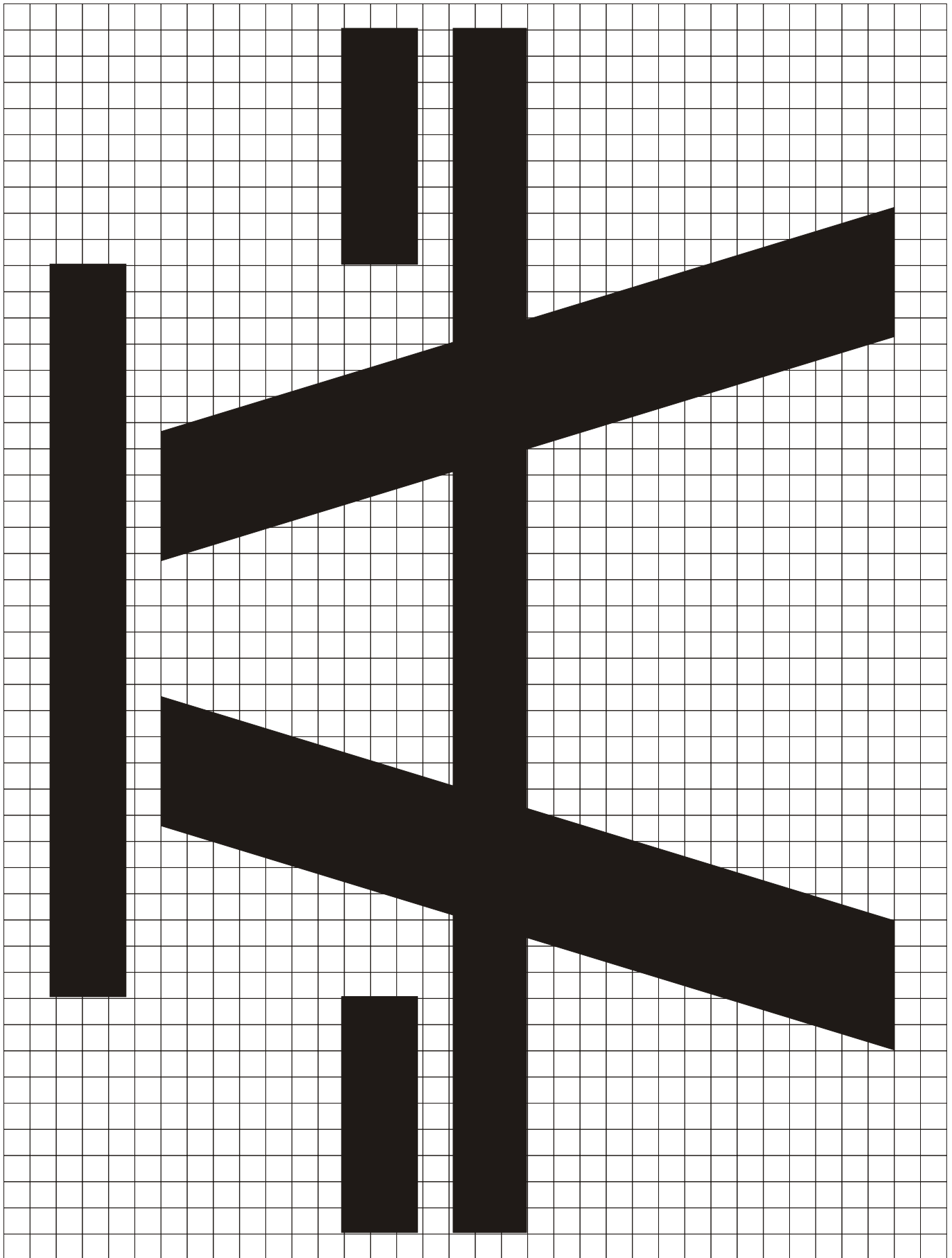

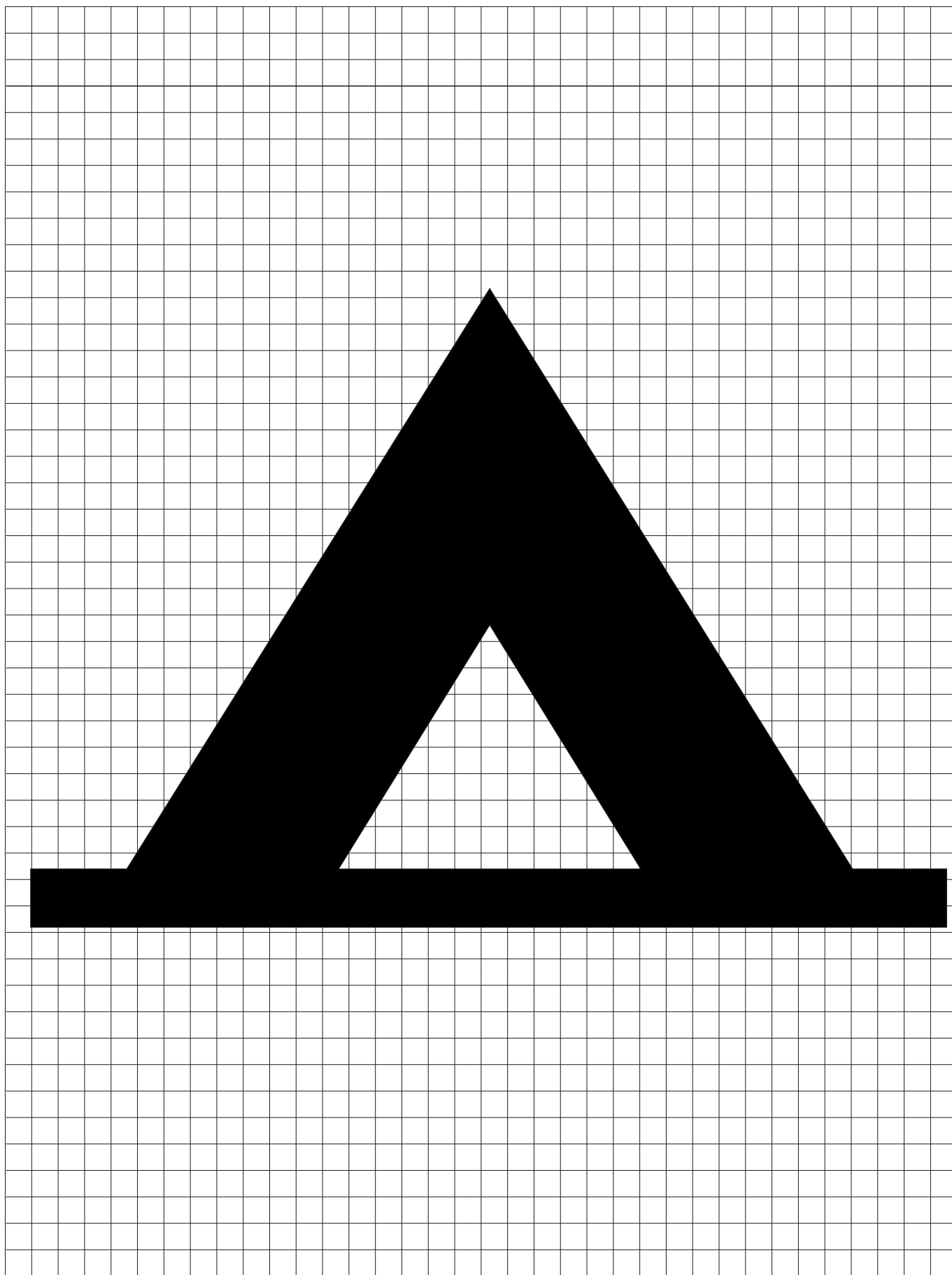

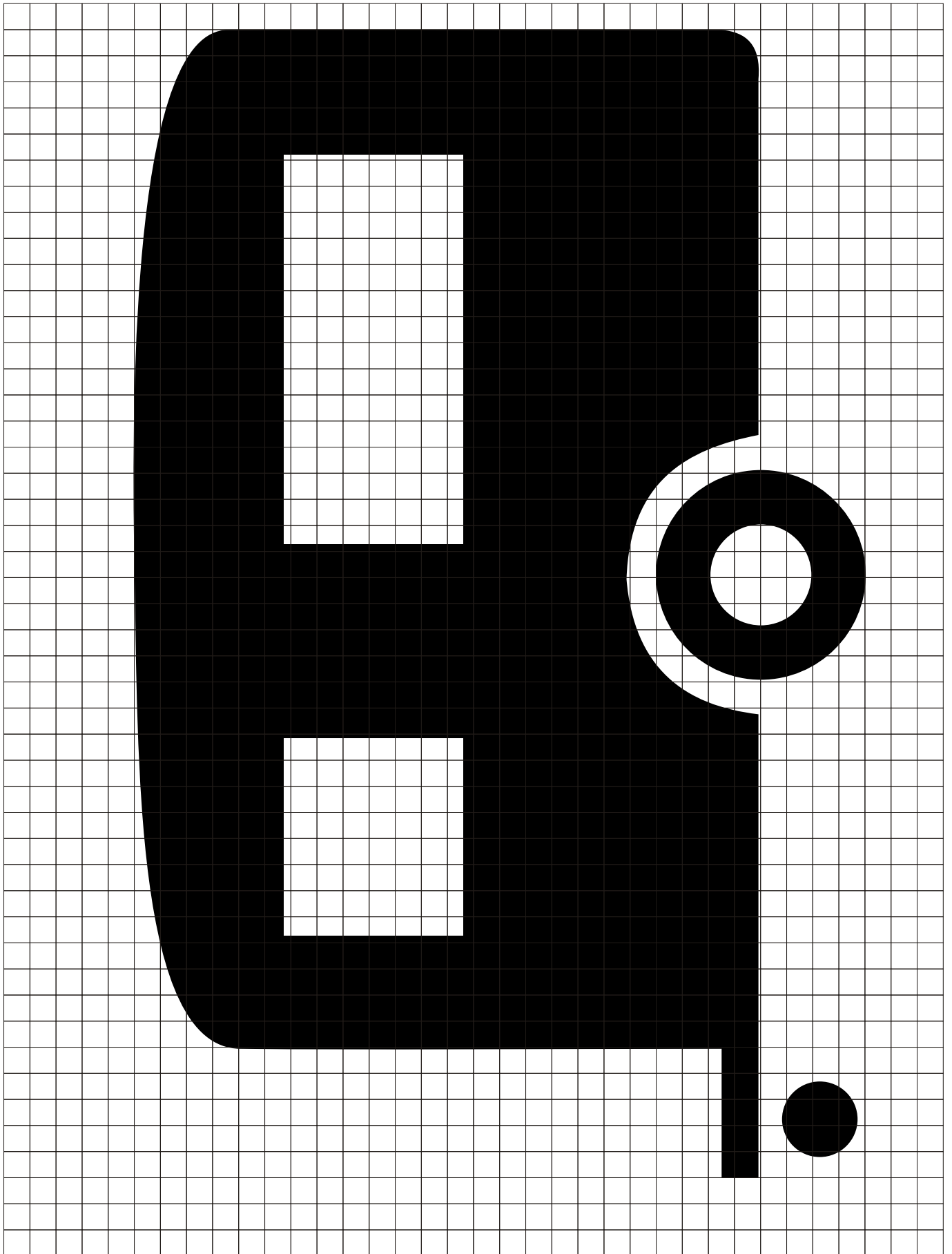

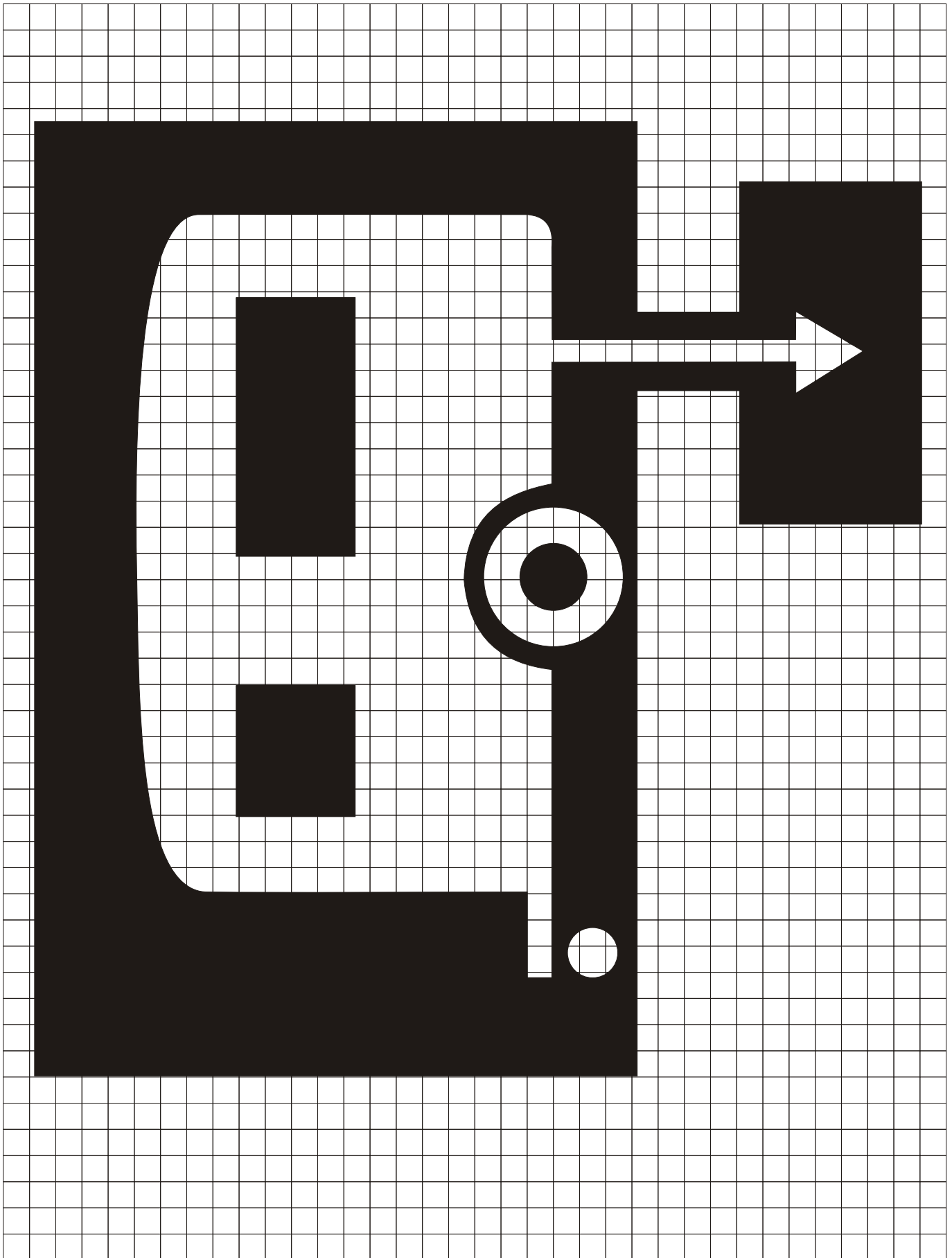

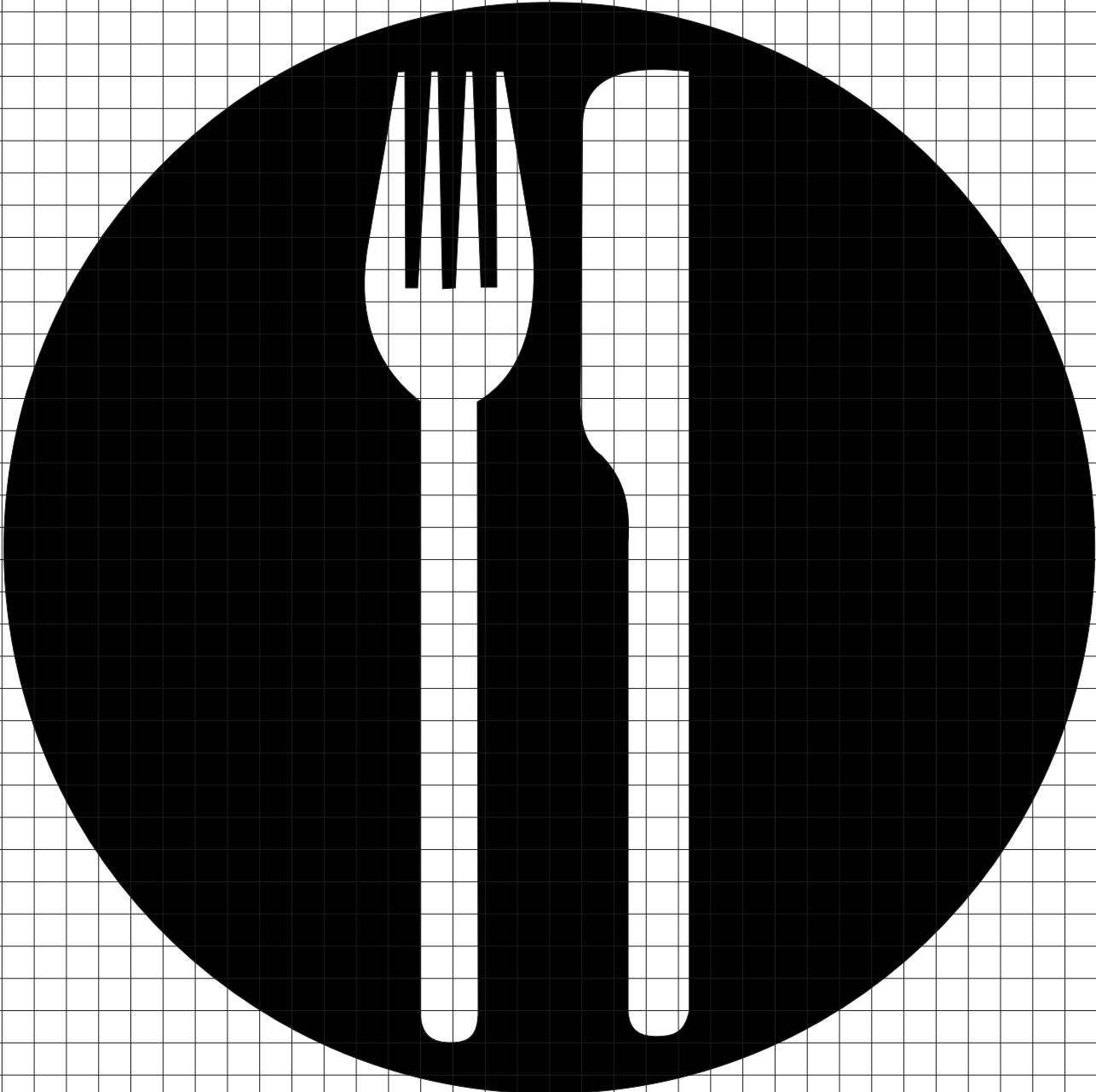

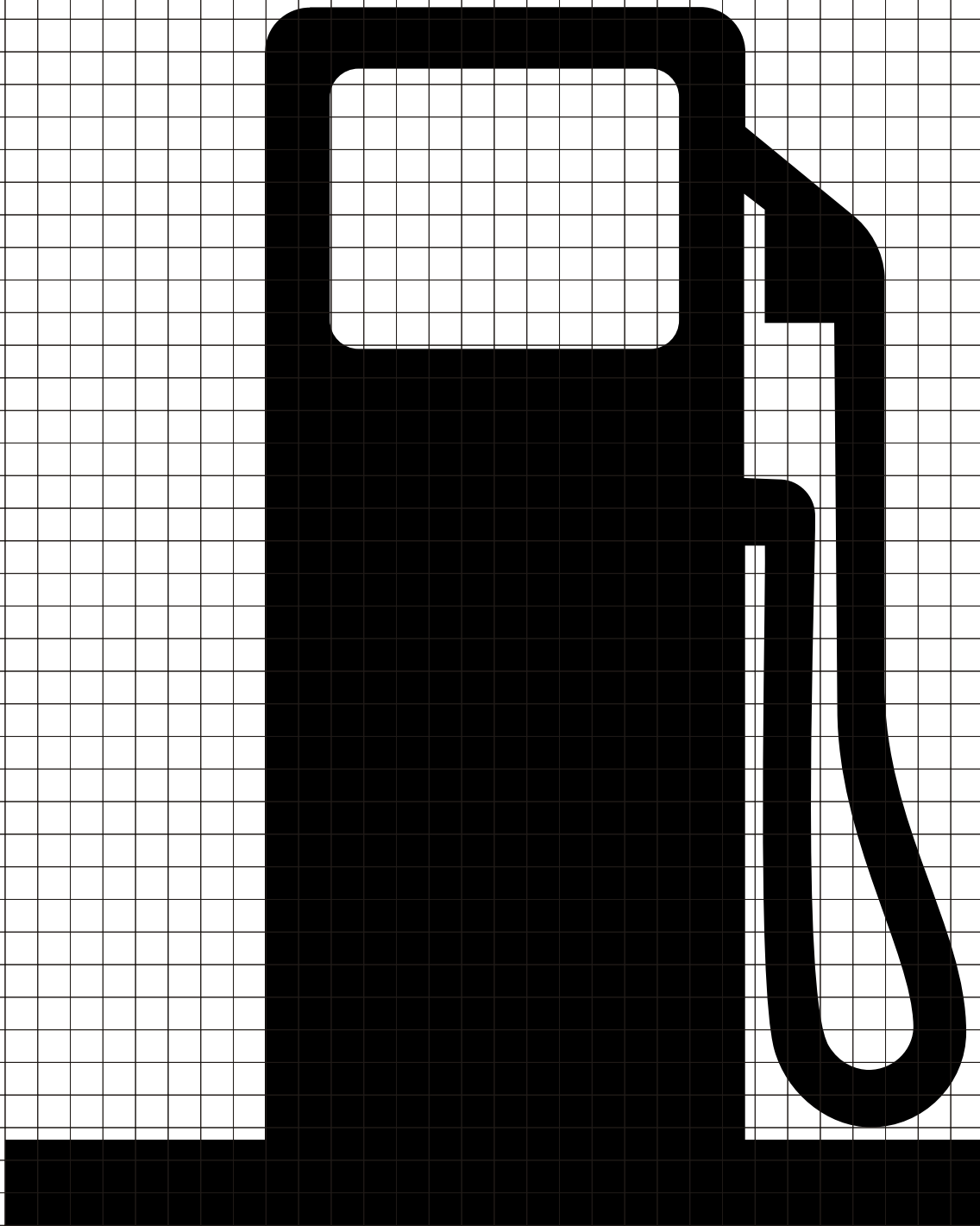

D9-7



D9-11



D9-11a

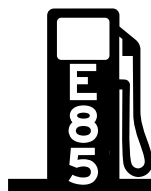

D9-11c



D9-11d

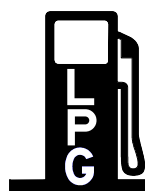

D9-11e



D9-11f



D9-11gT

See sign details for more information

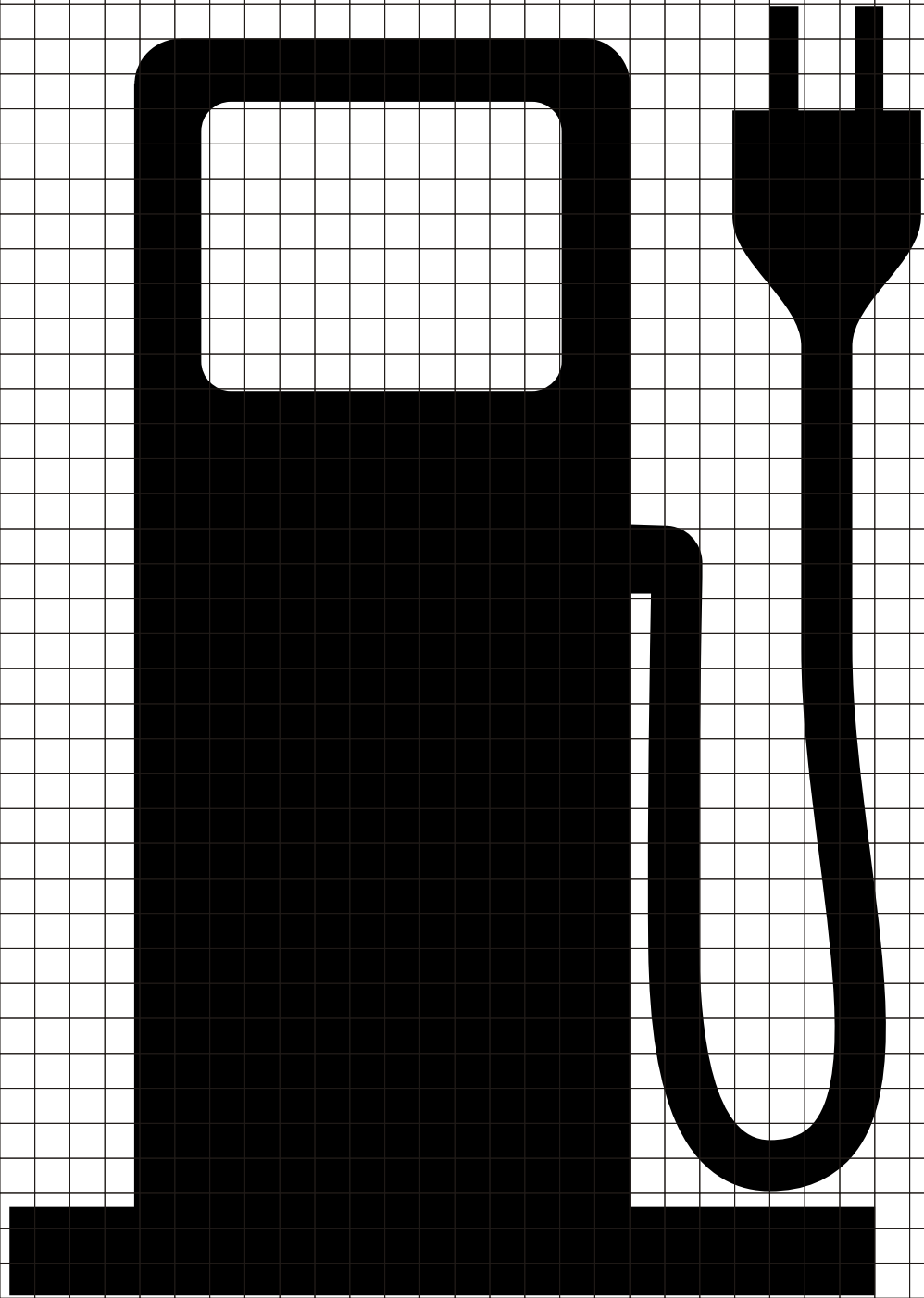

W9-11b

See sign details for more information

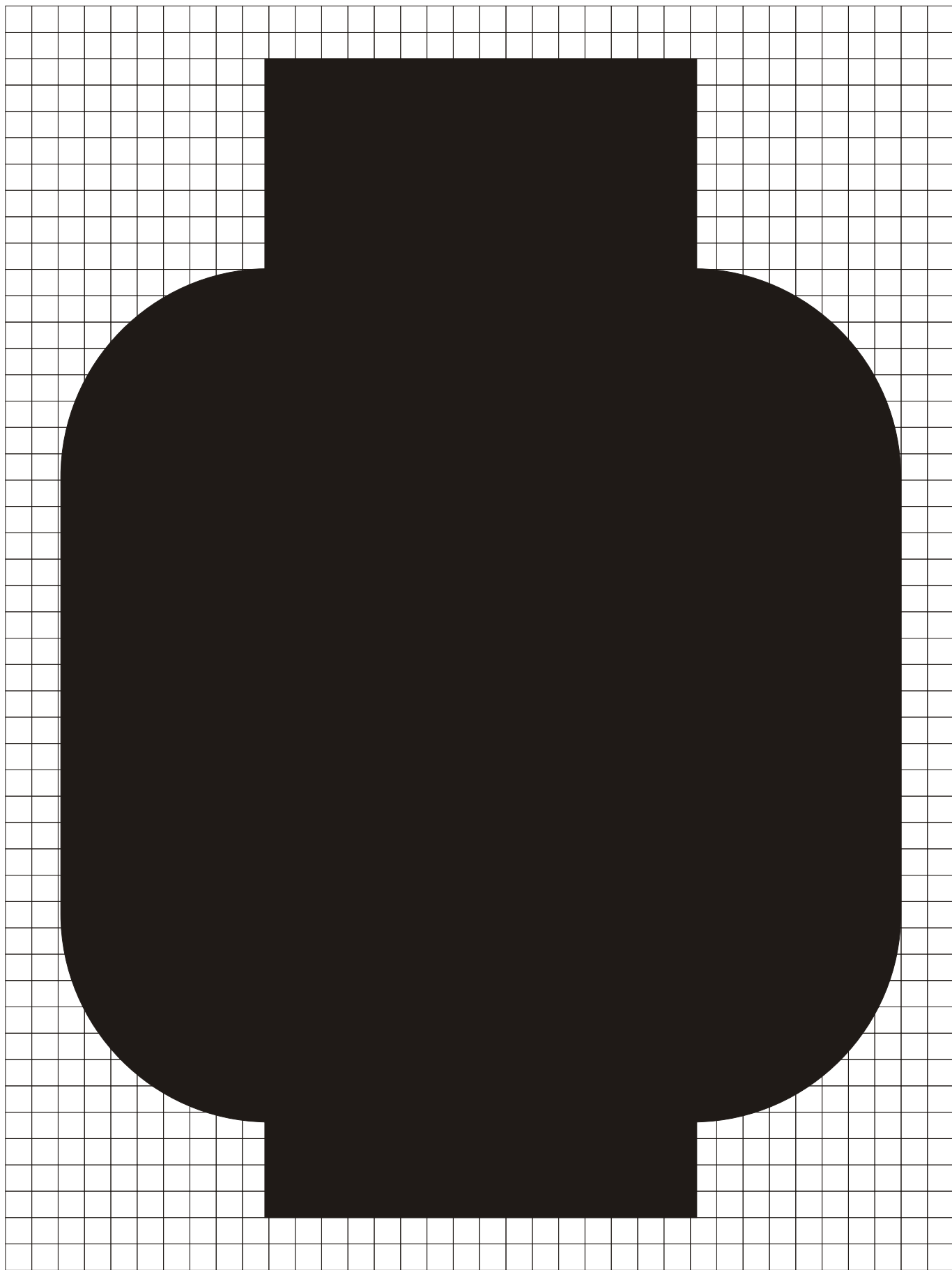

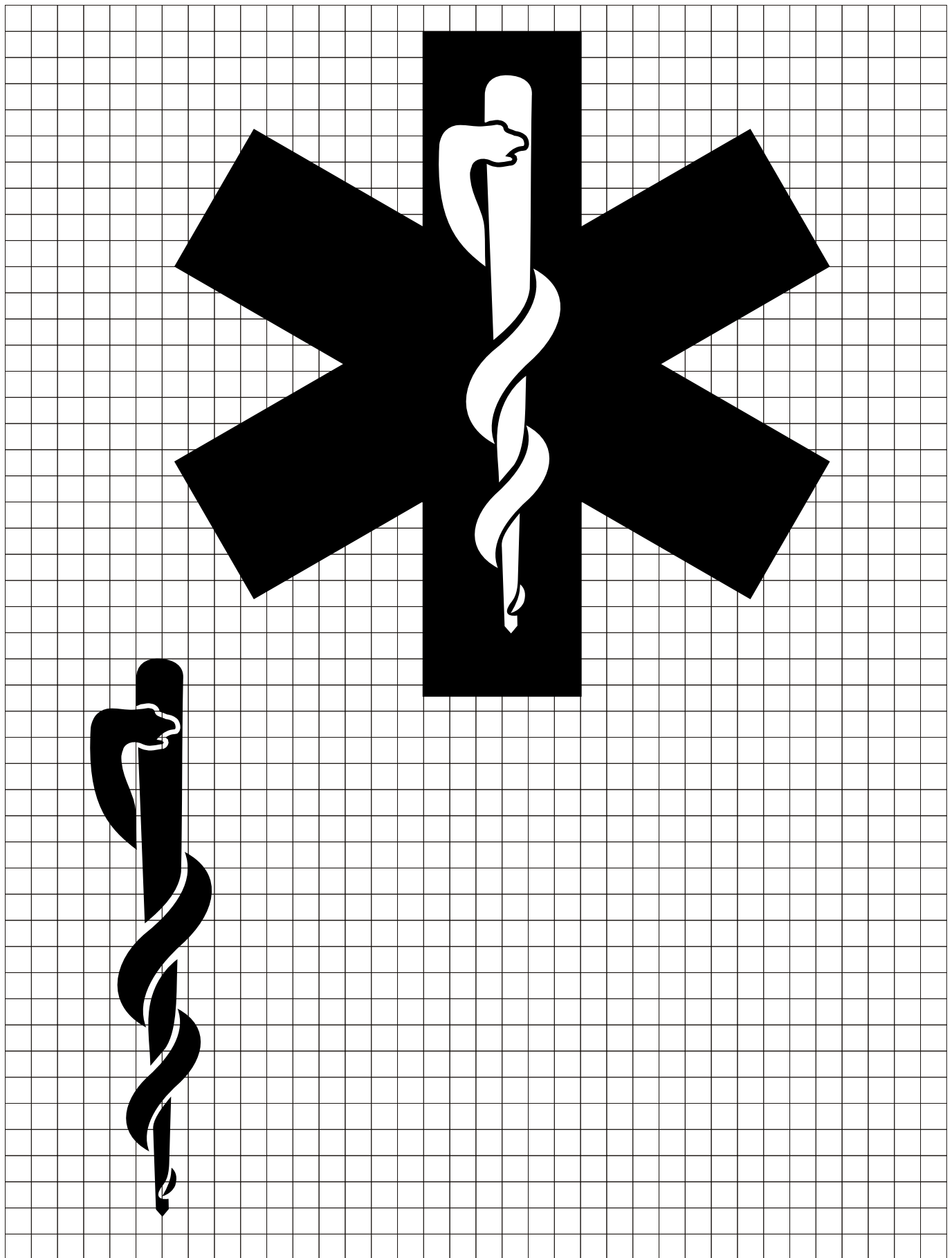

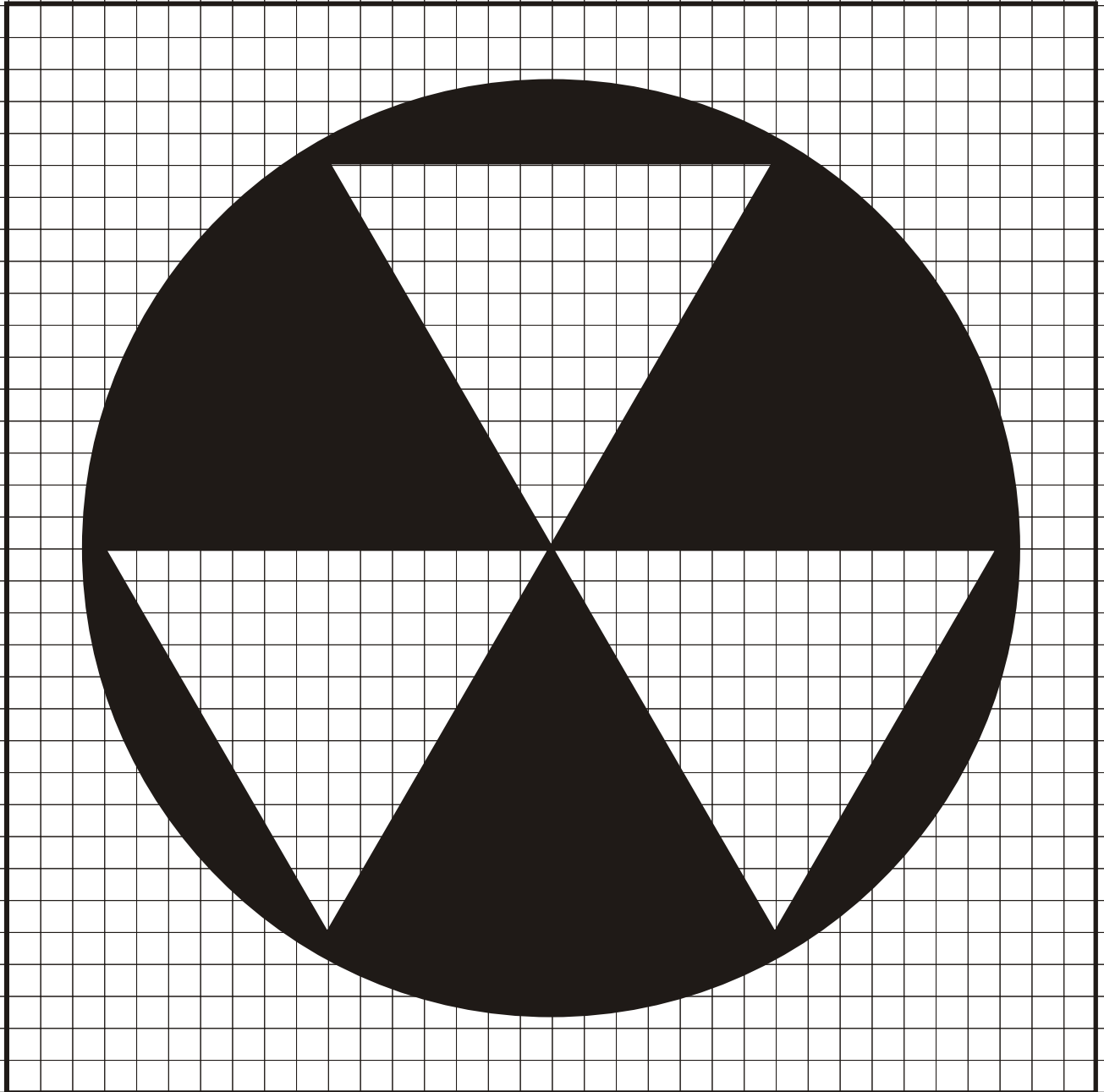

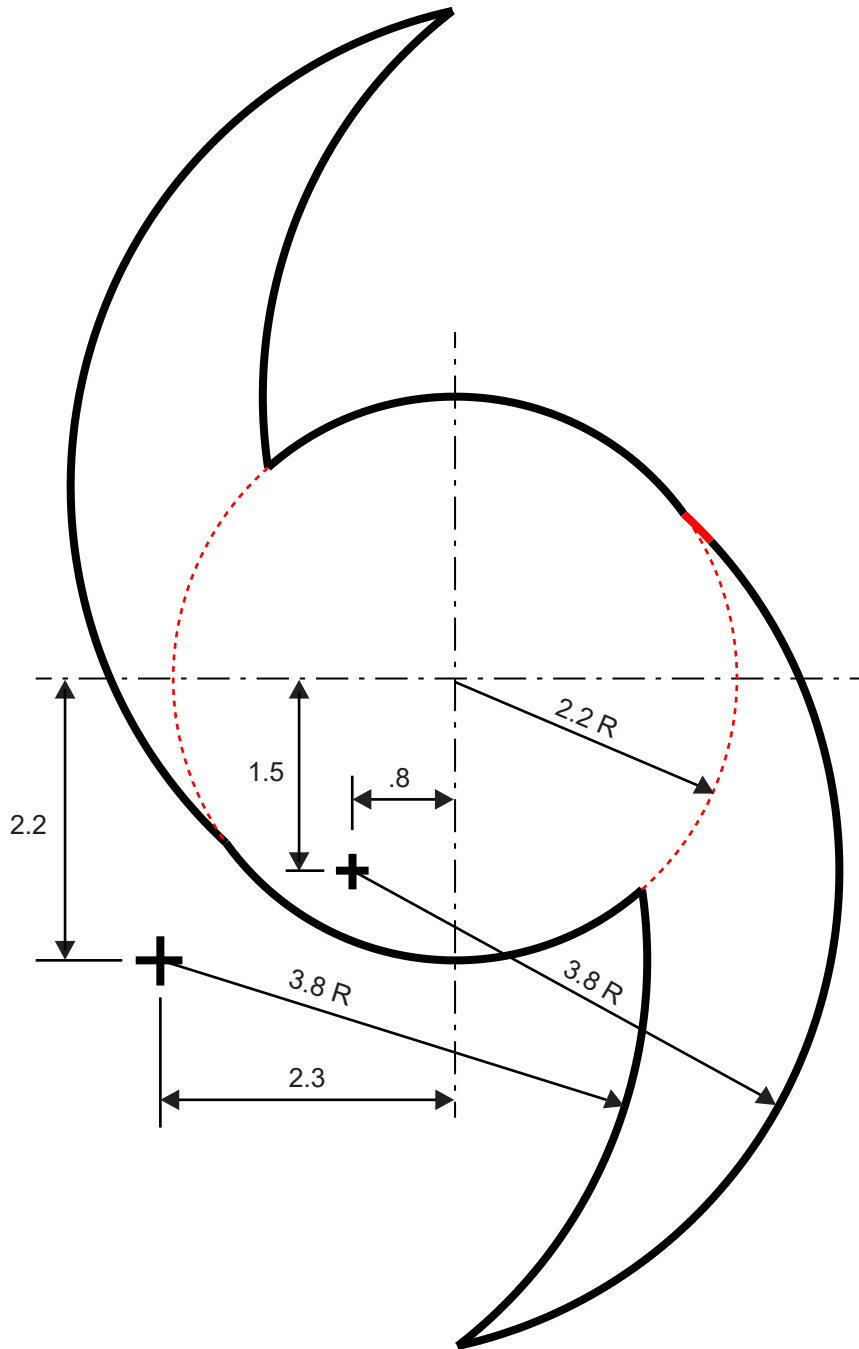

TEXAS

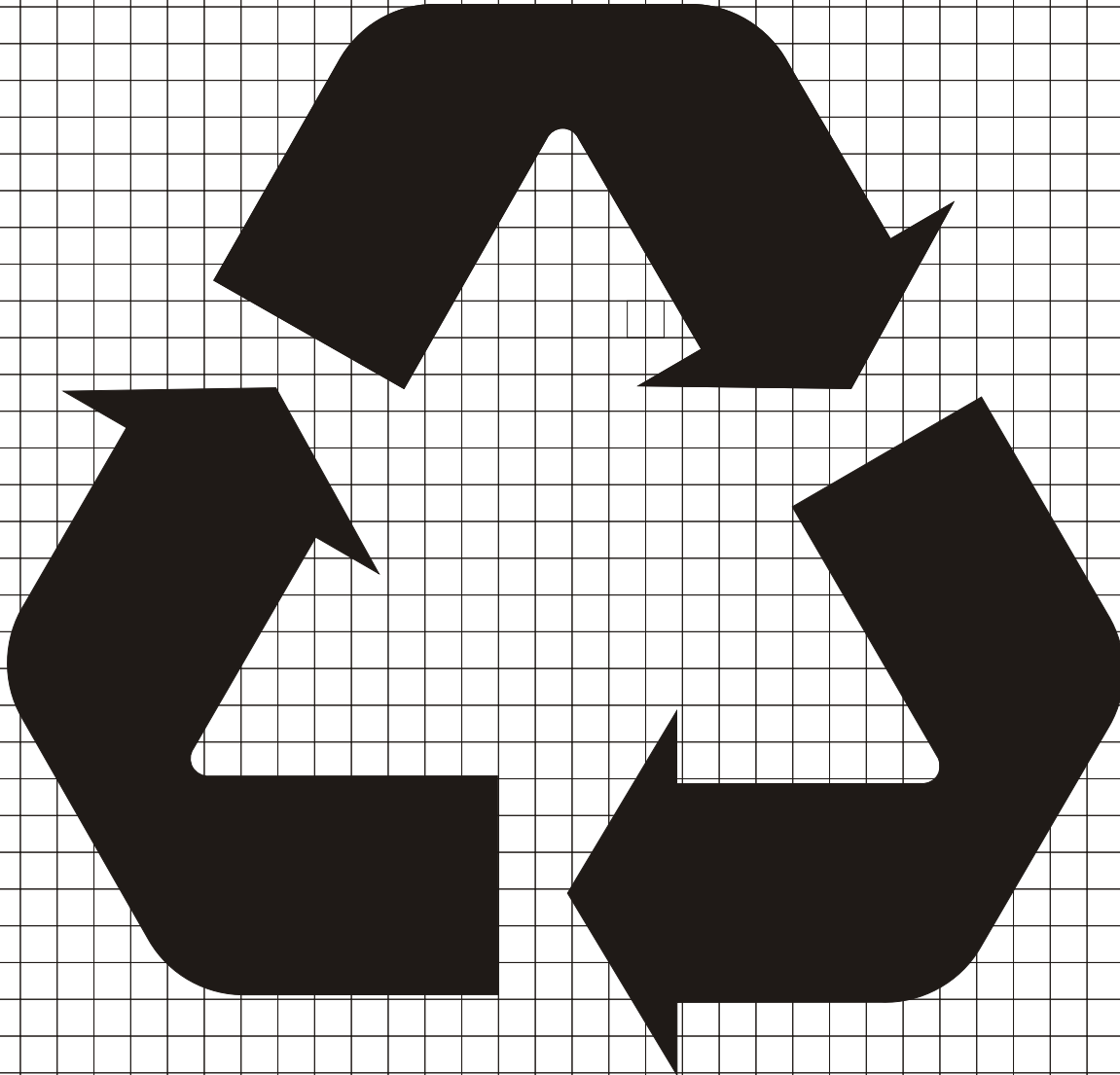





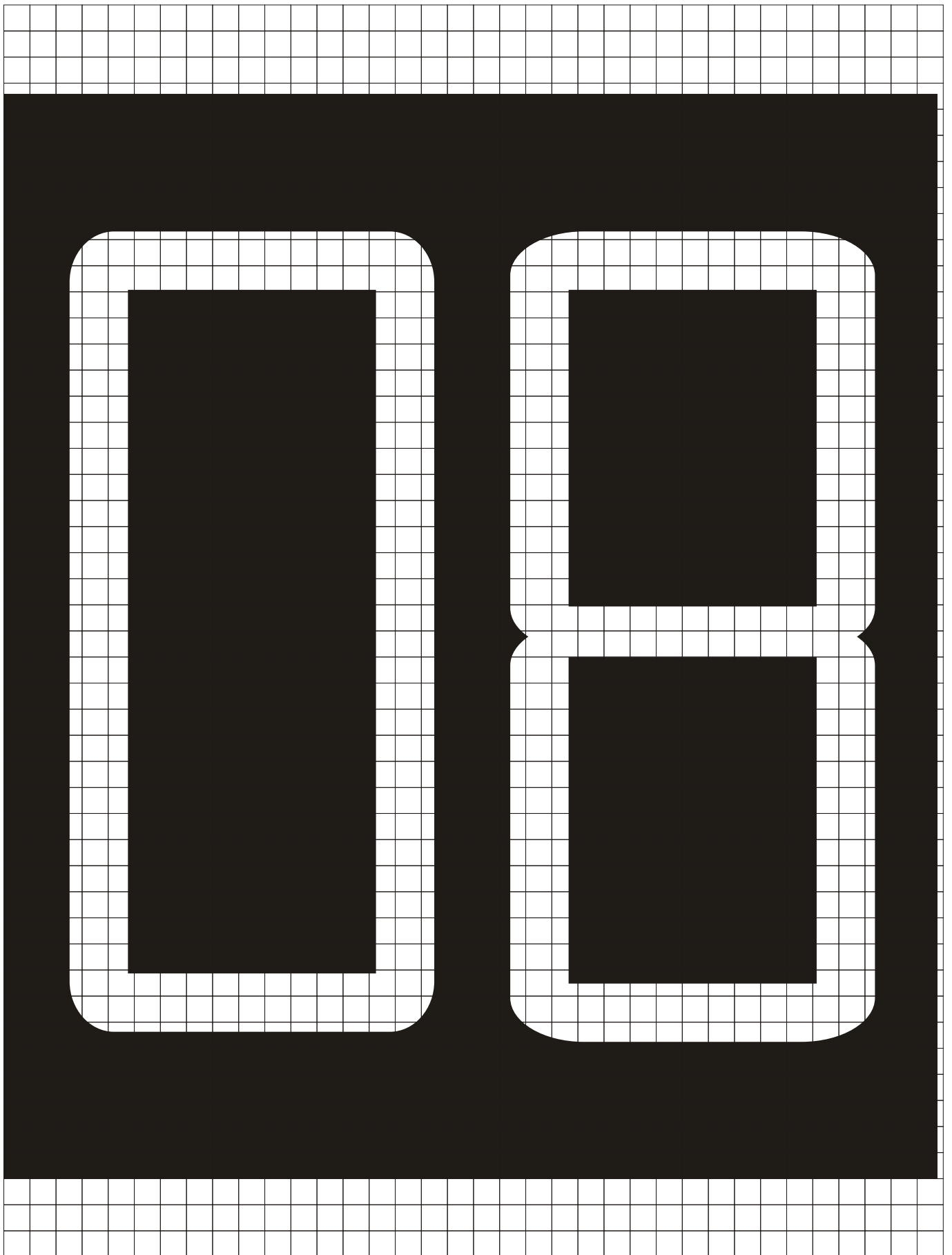

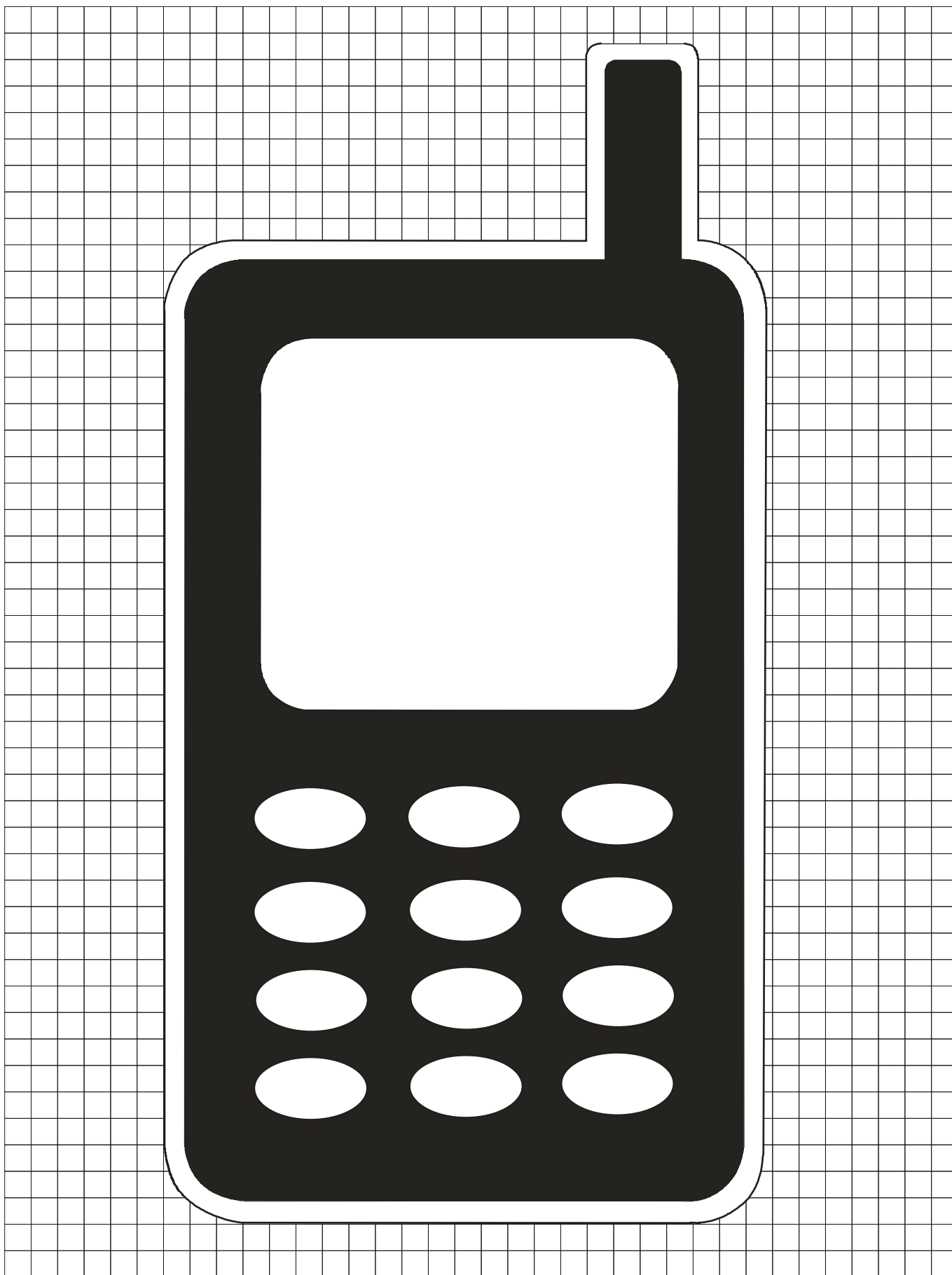

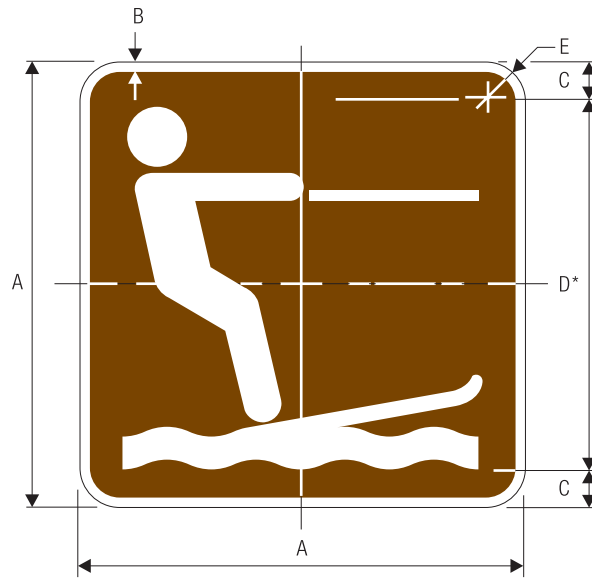

RS-058

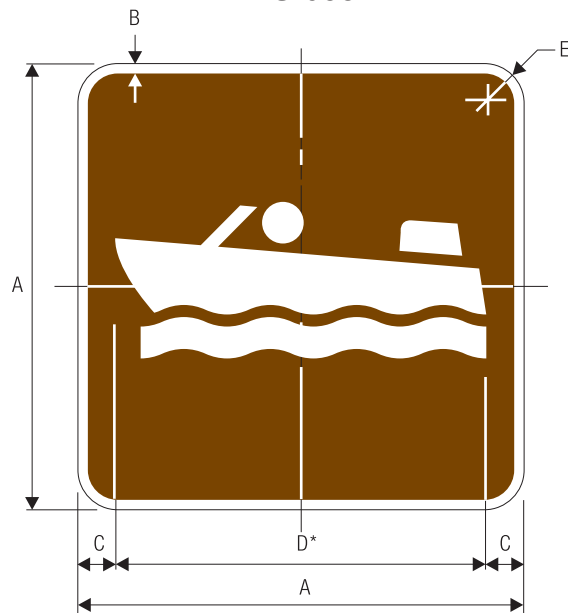

RS-055

* The largest dimension of most symbols should be about 83.5% of the total sign width. Symbols for showers, trailer sanitary stations, boat tours, interpretative trails, and climbing areas should extend near or into the sign border as shown in the grid layouts.

A	B	C	D	E
24	.5	2	20	1.5
18	.5	1.5	15	1.5

COLORS: LEGEND — WHITE (REFLECTIVE)
BACKGROUND — BROWN

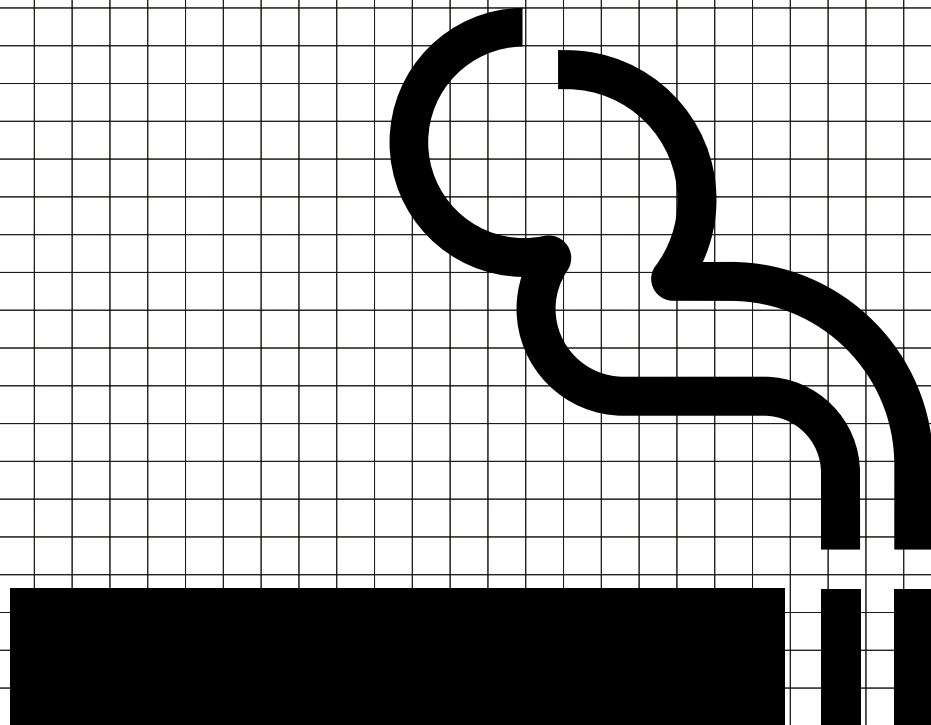

RS-002
Smoking

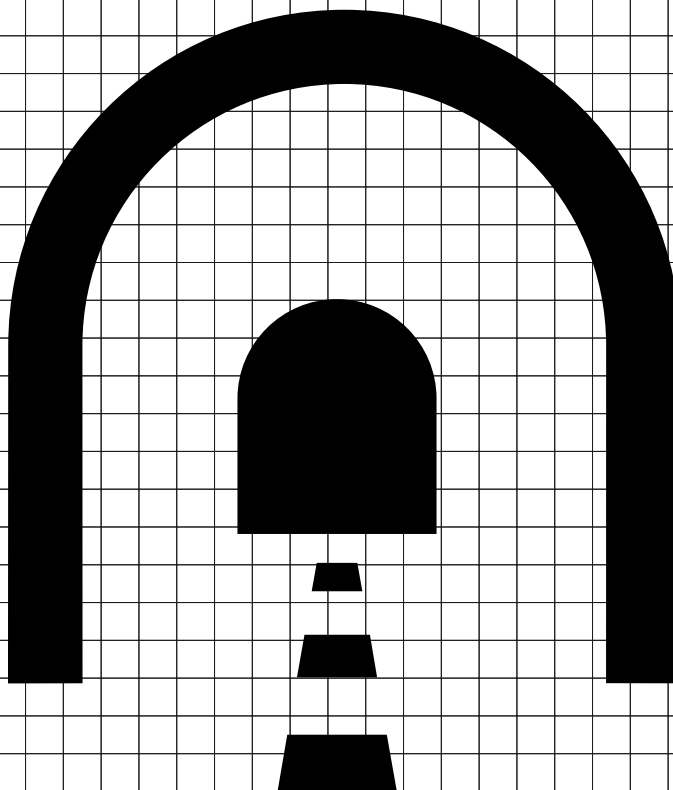

RS-005
Tunnel

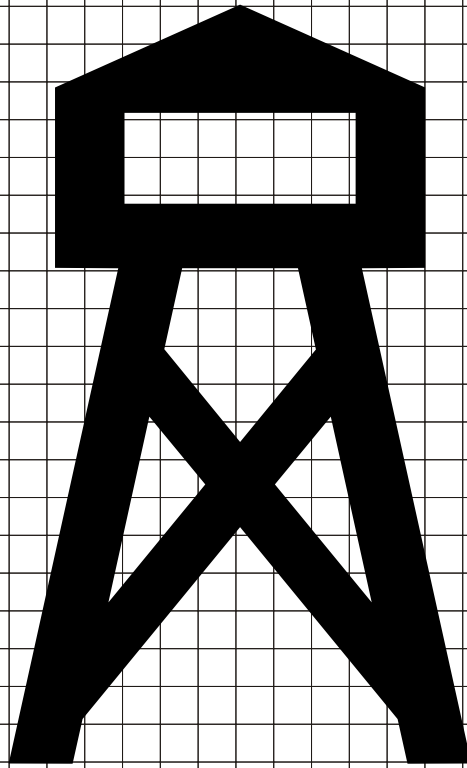

RS-006
Lookout Tower

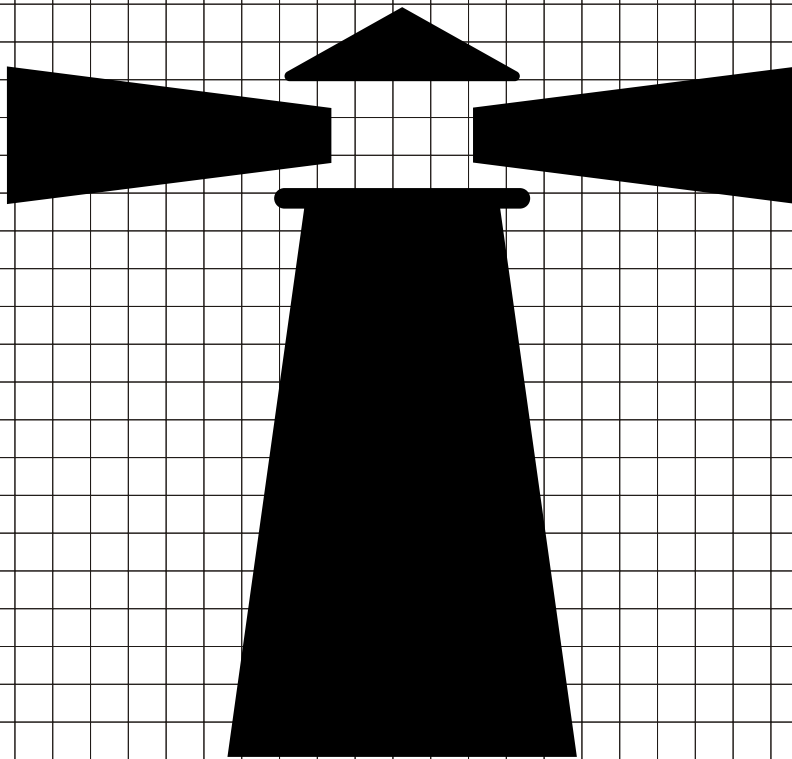

RS-007
Lighthouse

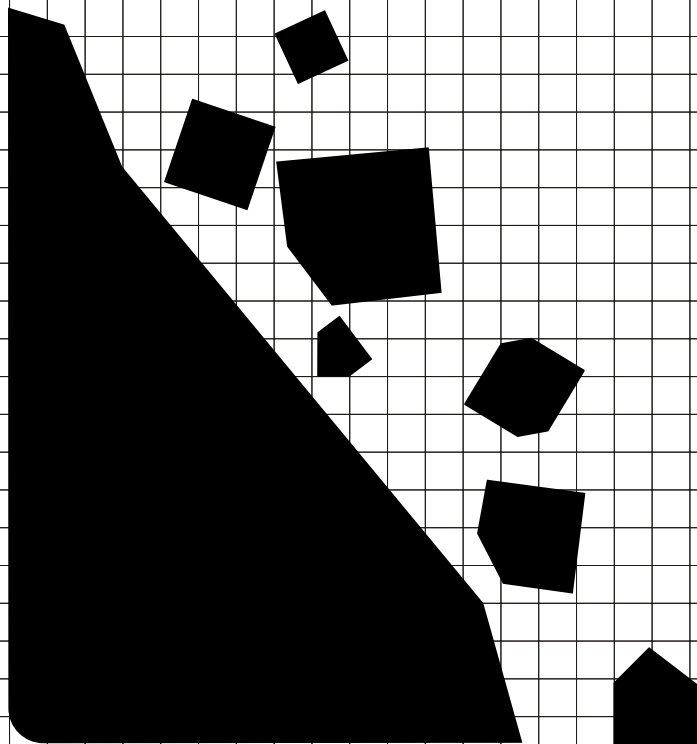

RS-008
Falling Rocks

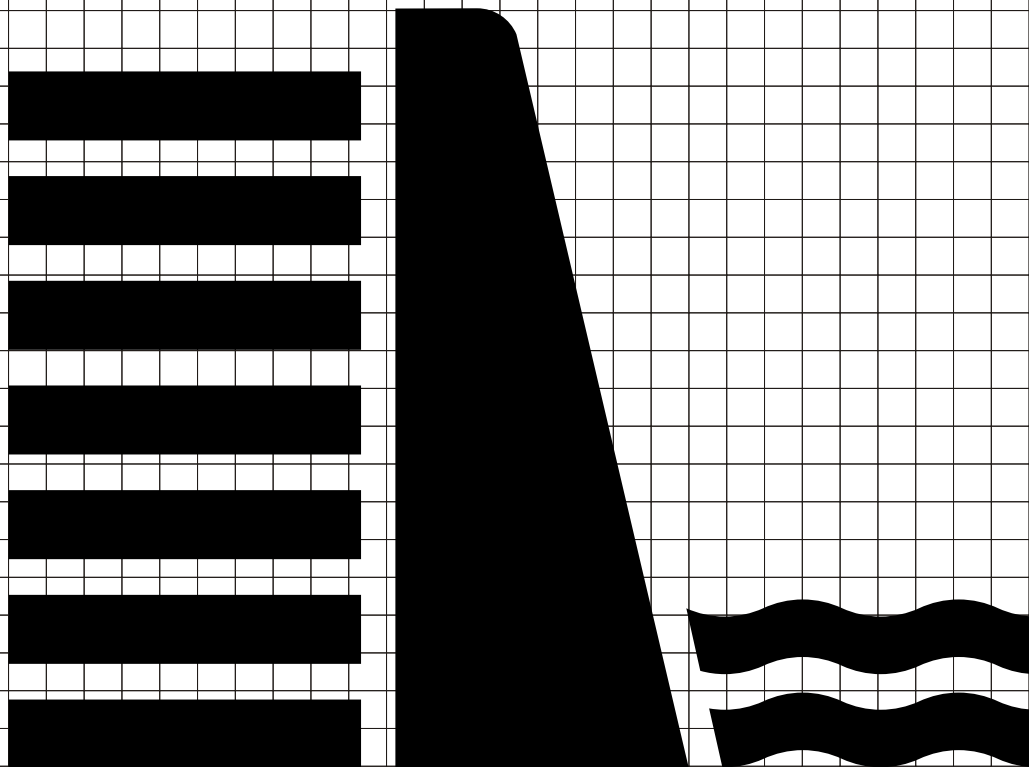

RS-009
Dam

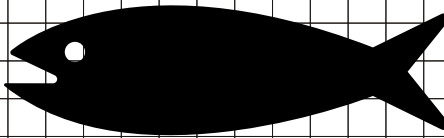
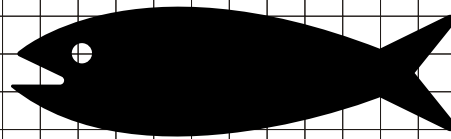
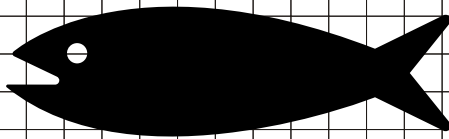
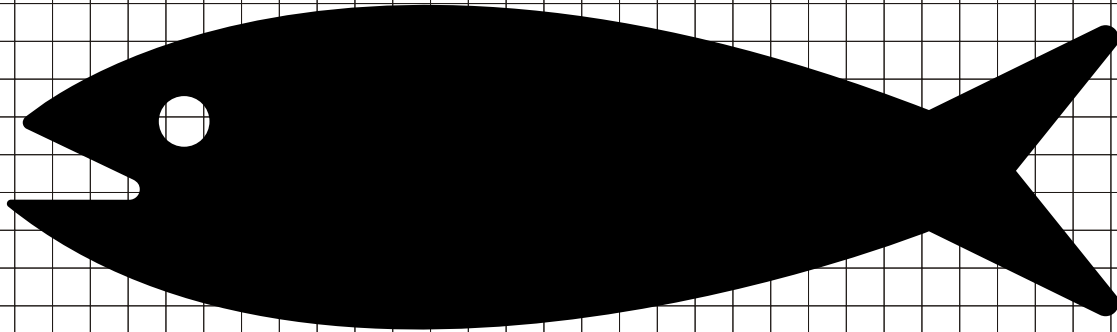

RS-010
Fish Hatchery

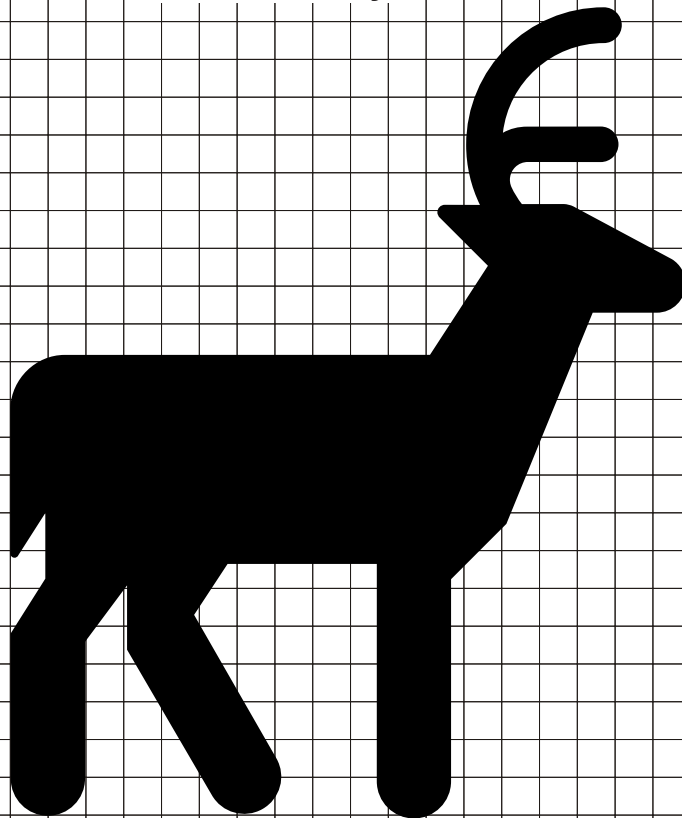

RS-011
Deer Viewing Area

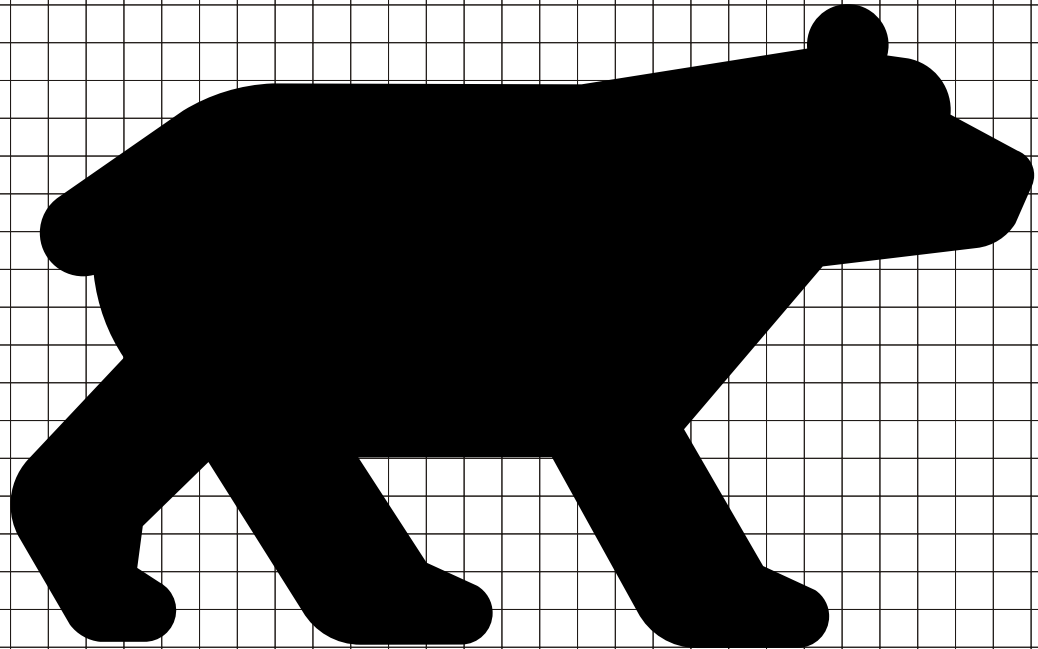

RS-012
Bear Viewing Area

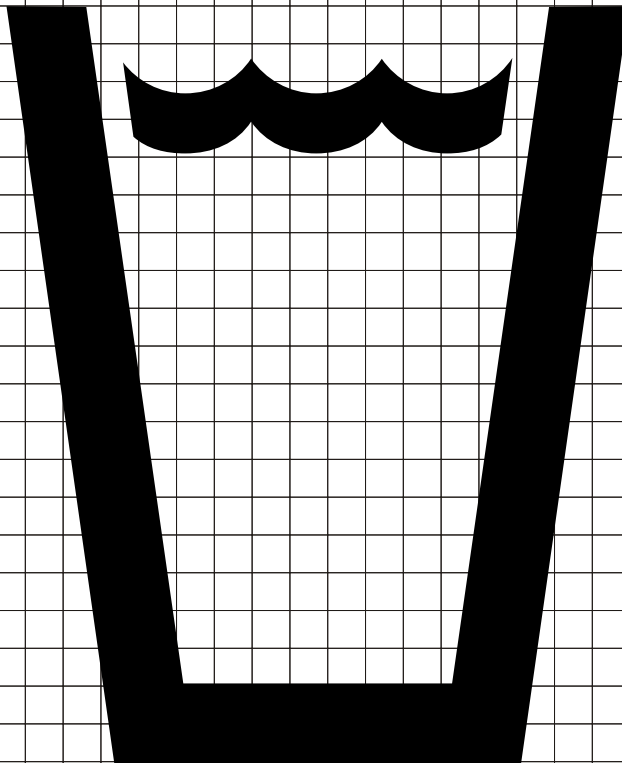

RS-013
Drinking Water

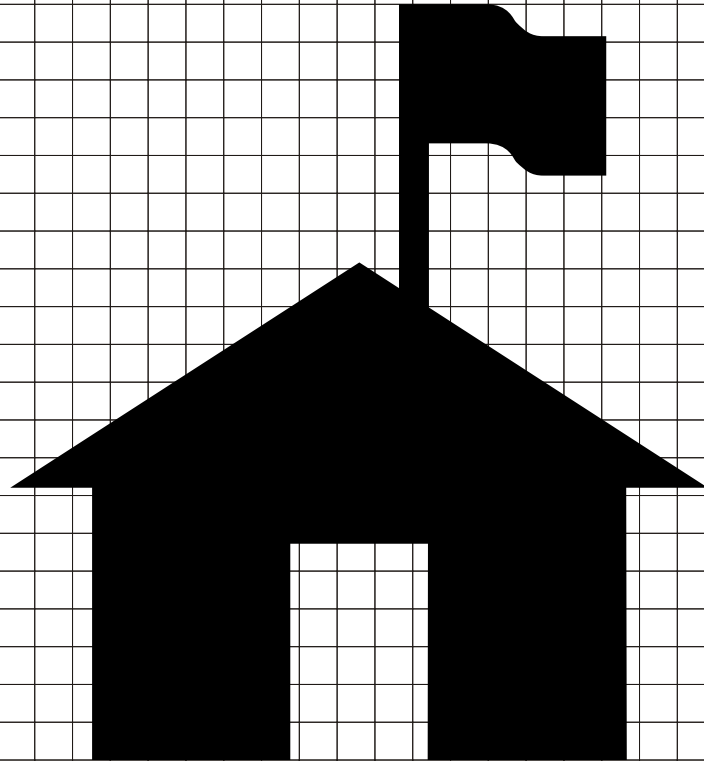

RS-015
Ranger Station

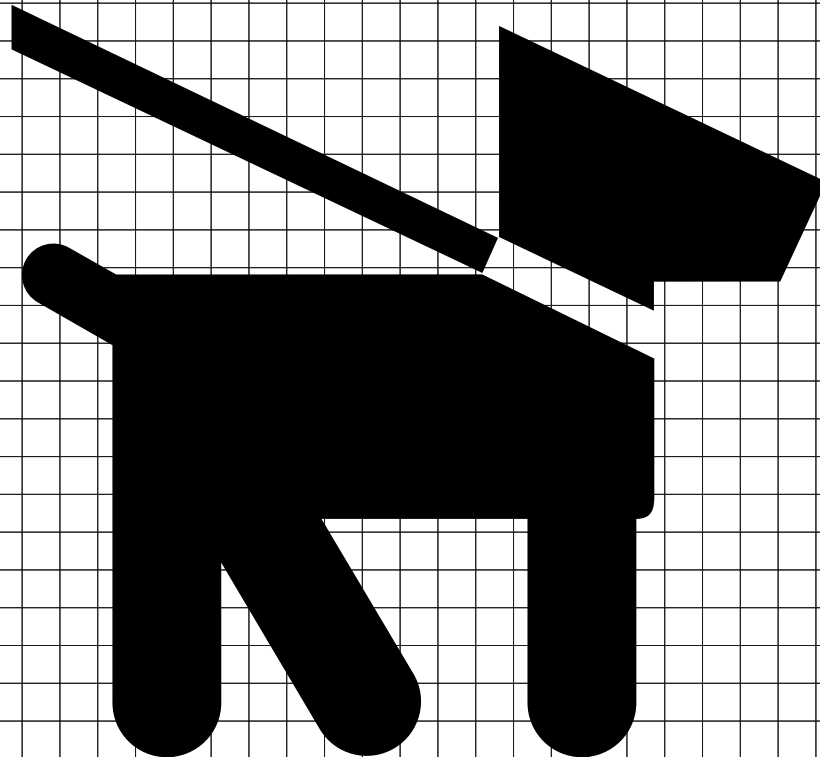

RS-017
Pets on Leash

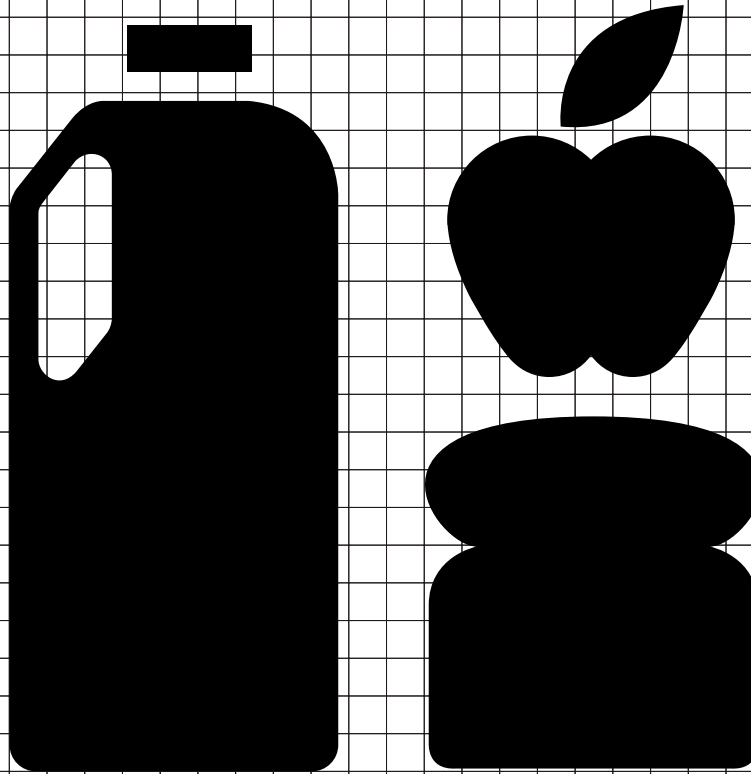

**RS-020
Grocery Store**

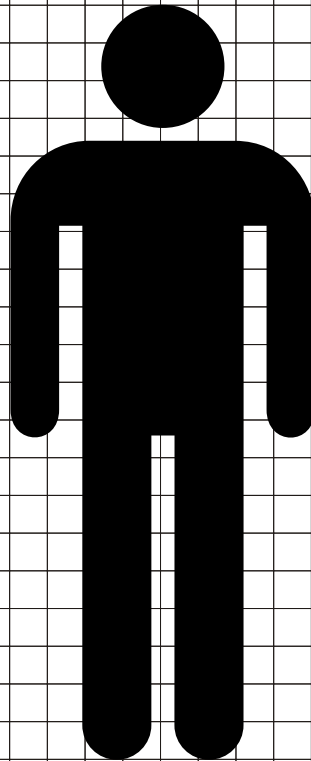

**RS-021
Men's Restroom**

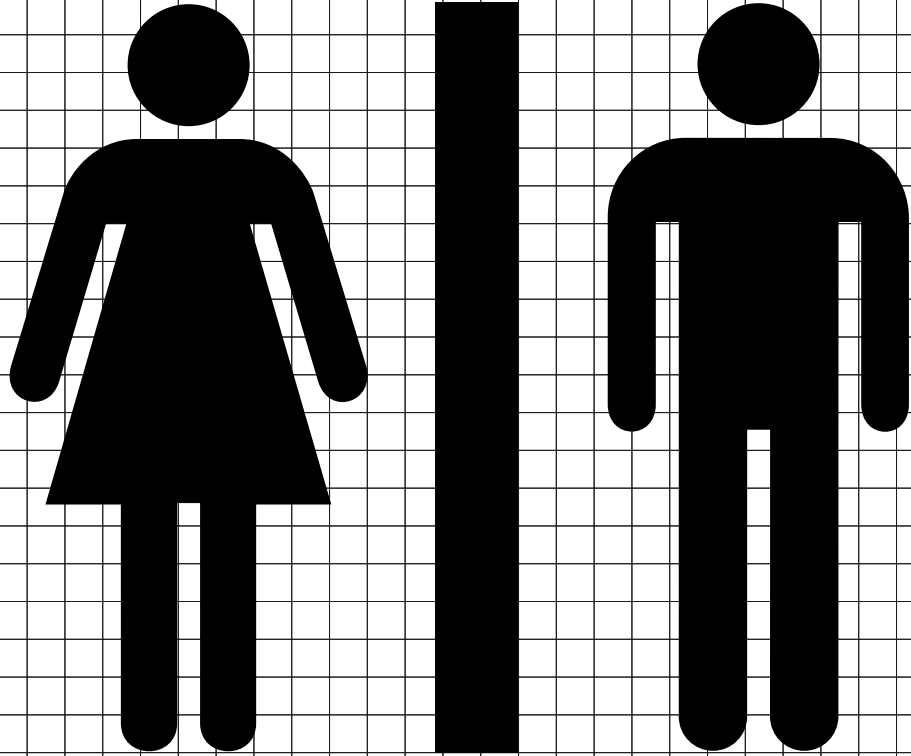

**RS-022
Restrooms**

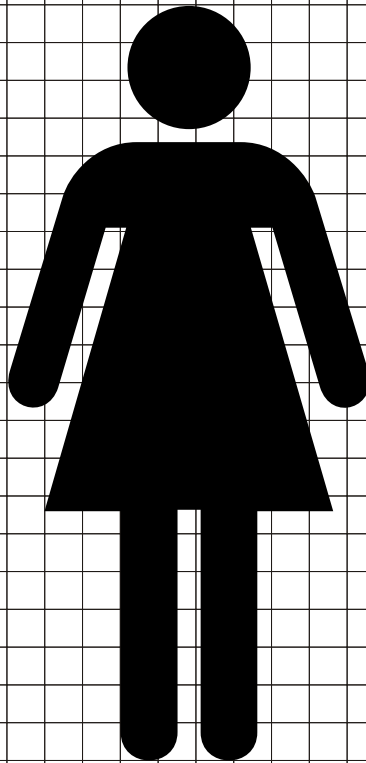

**RS-023
Women's Restroom**

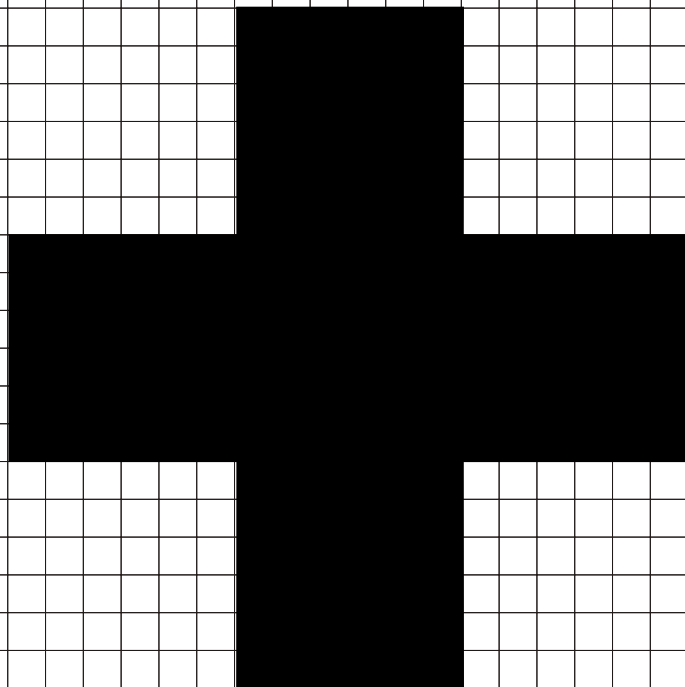

RS-024
First Aid

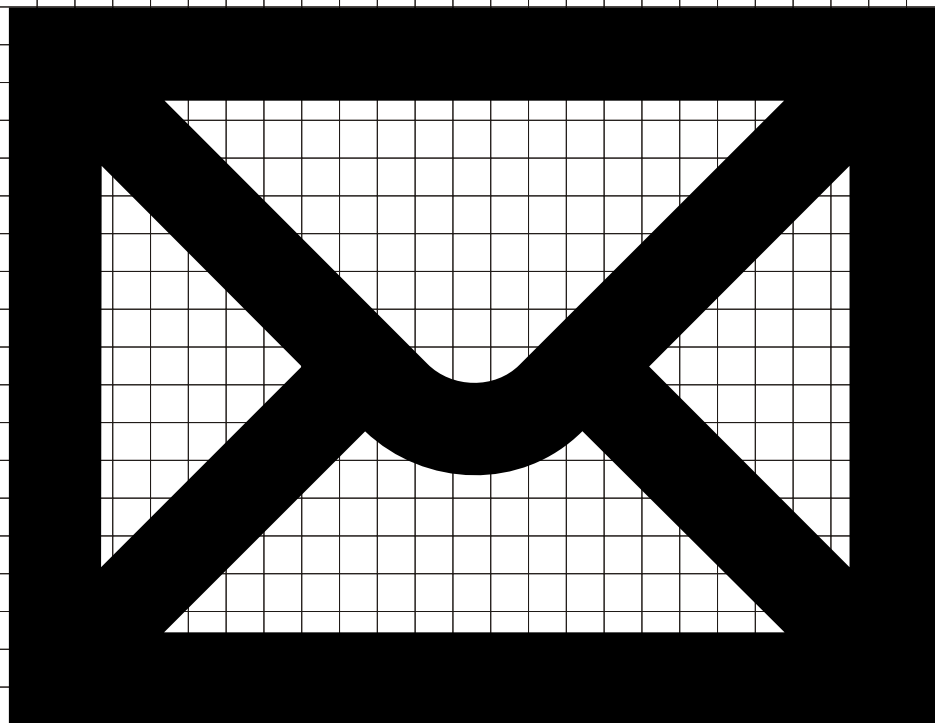

RS-026
Post Office

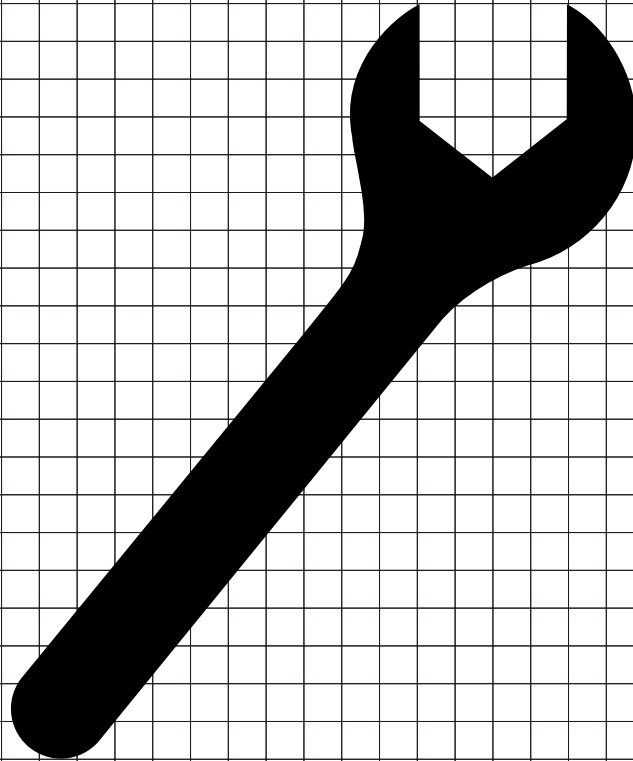

RS-027
Mechanic

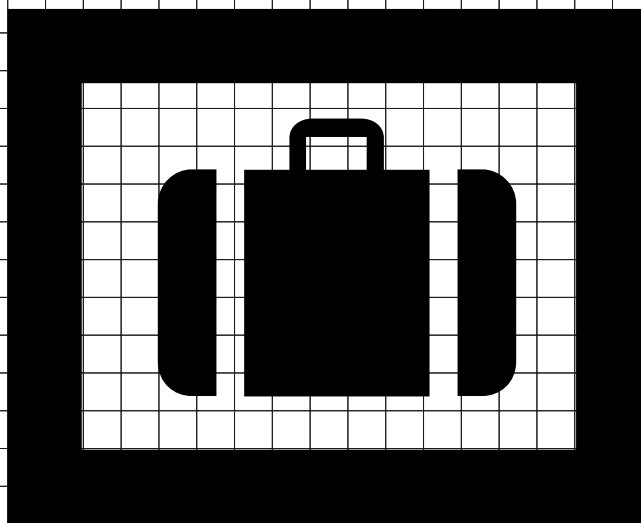
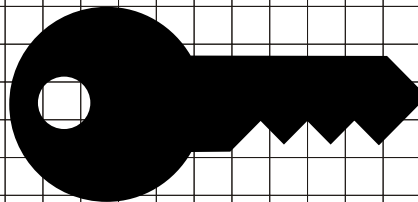

RS-030
Lockers/Storage

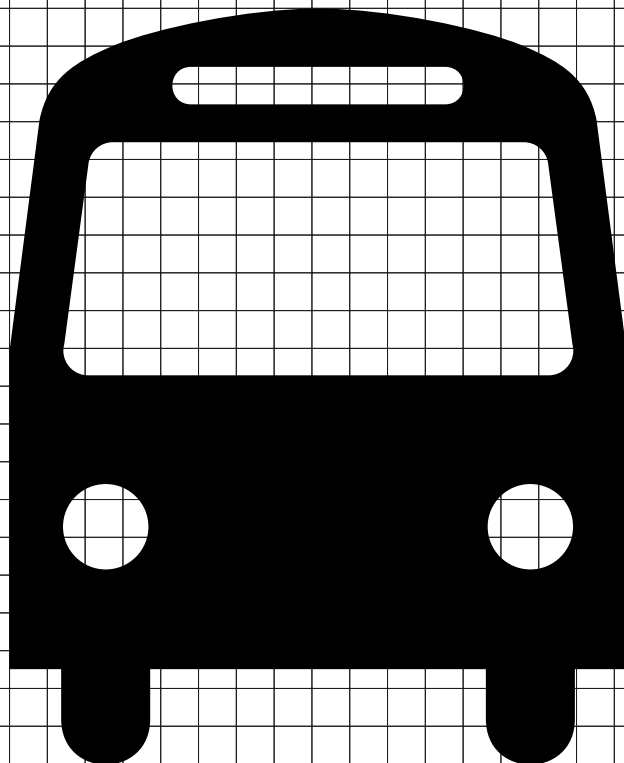

**RS-031
Bus Stop**

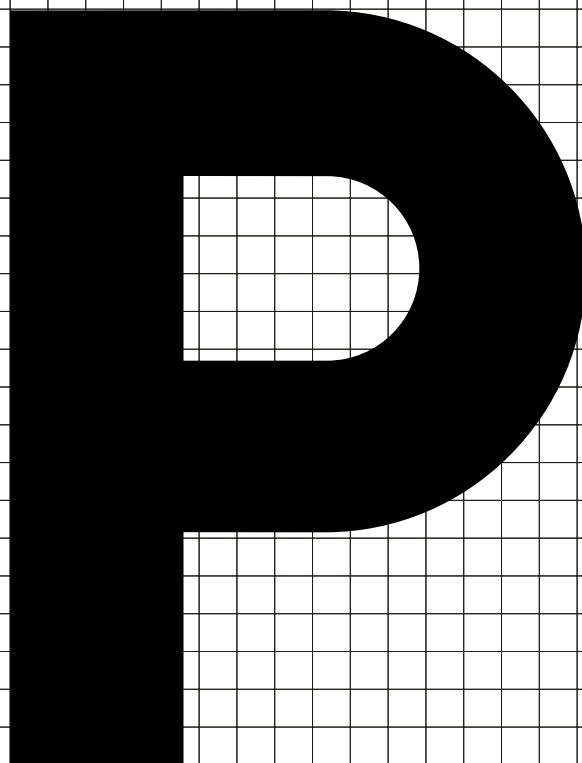

**RS-034
Parking**

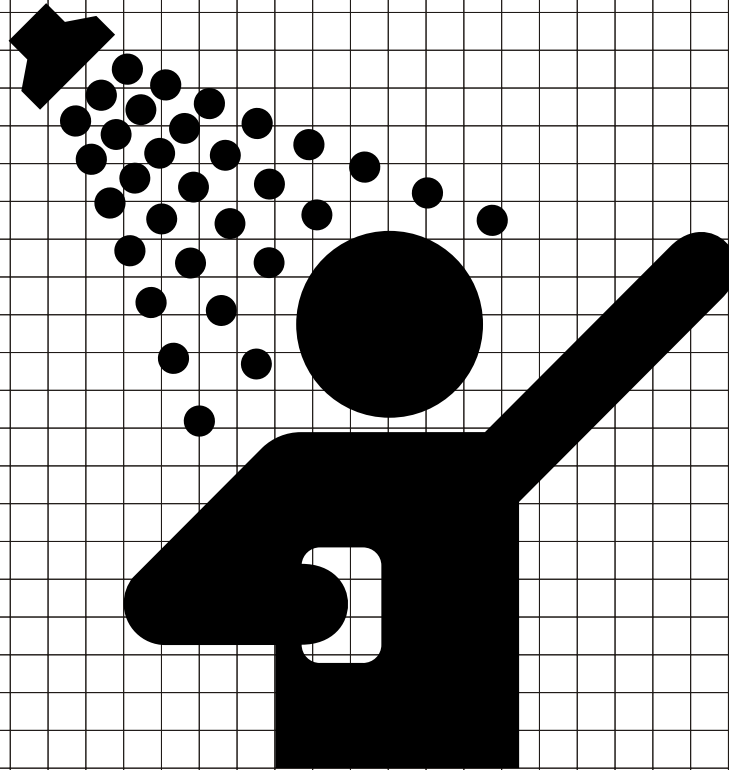

RS-035
Showers

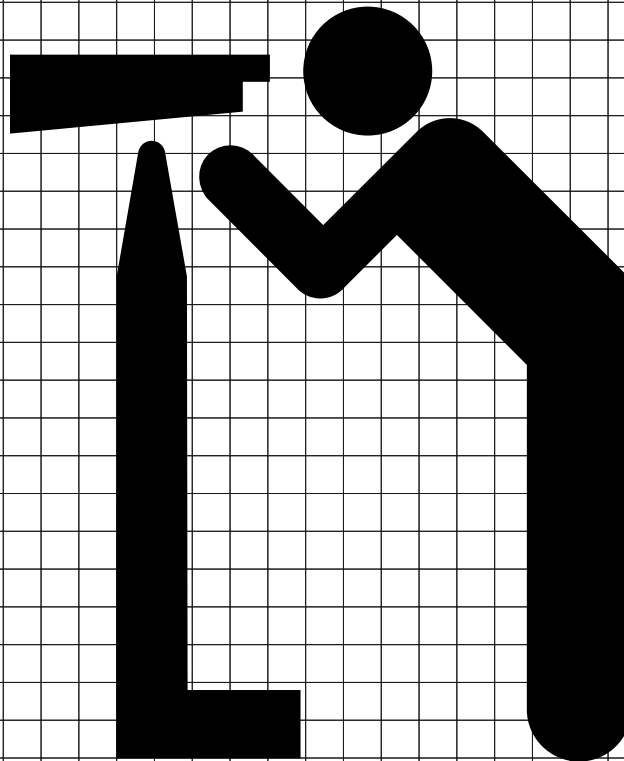

RS-036
Viewing Area

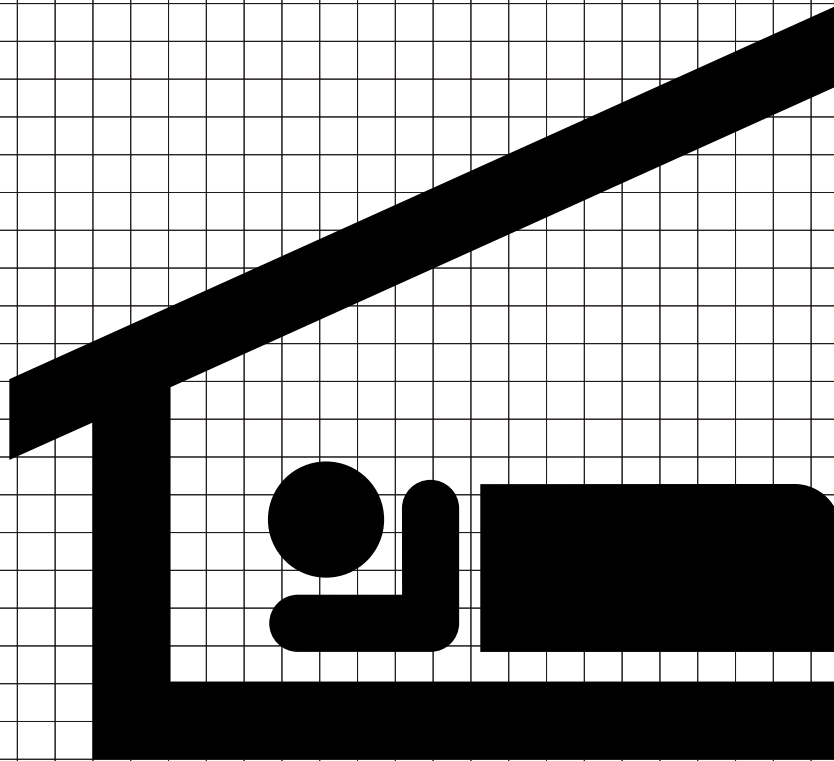

RS-037
Sleeping Shelter

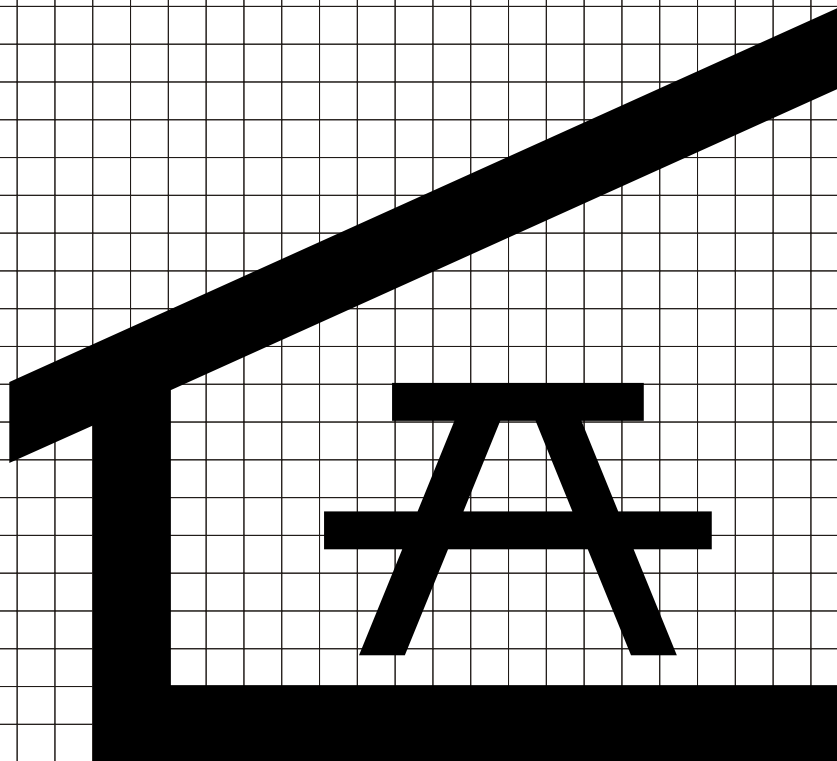

RS-039
Picnic Shelter

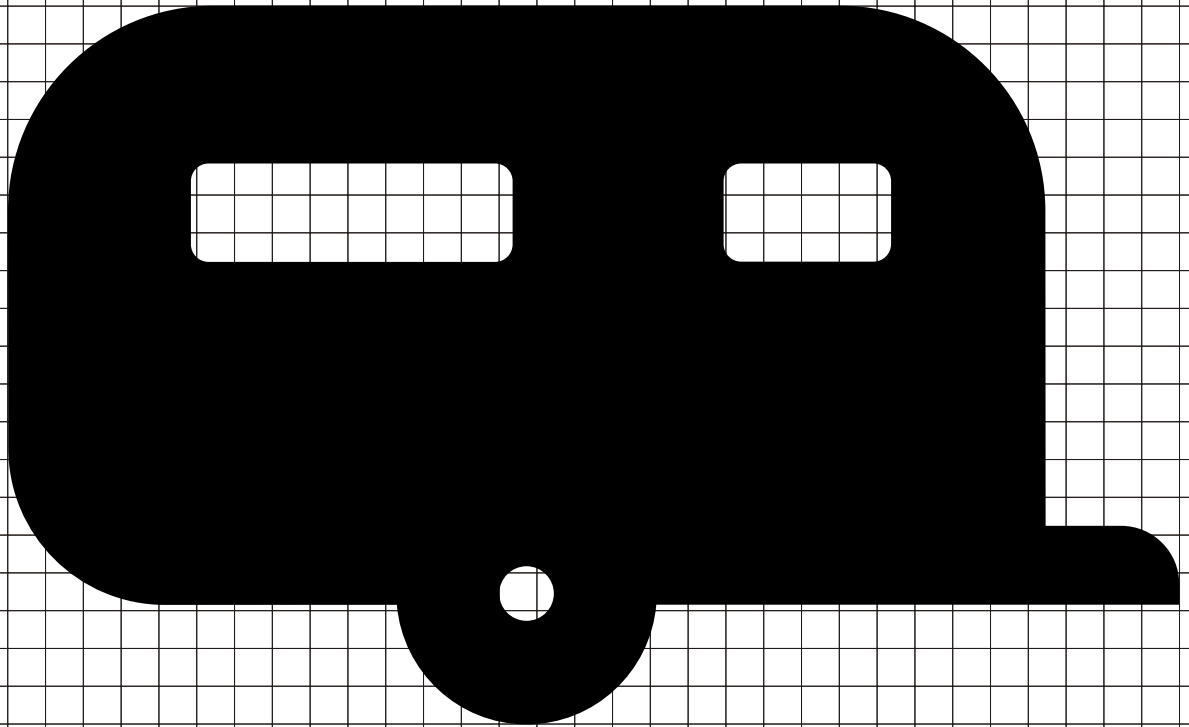

**RS-040
Trailer Site**

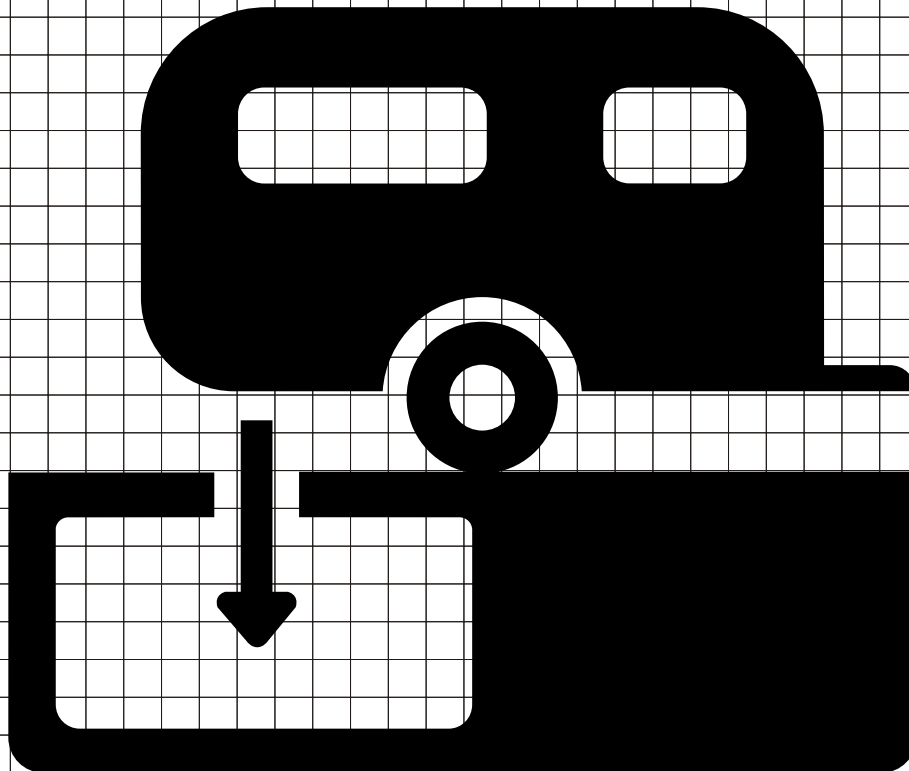

**RS-041
Sanitary Station**

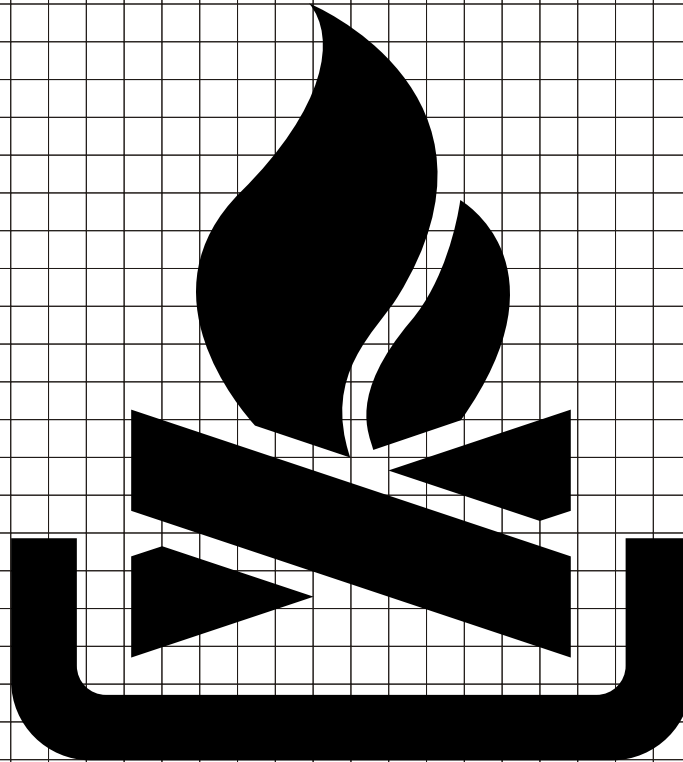

RS-042
Campfires

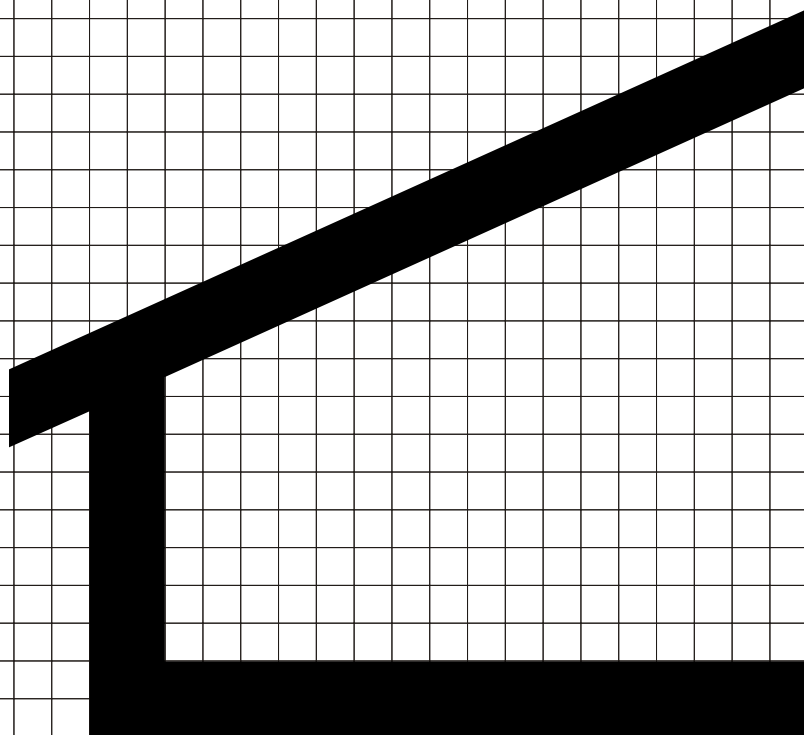

RS-043
Trail Shelter

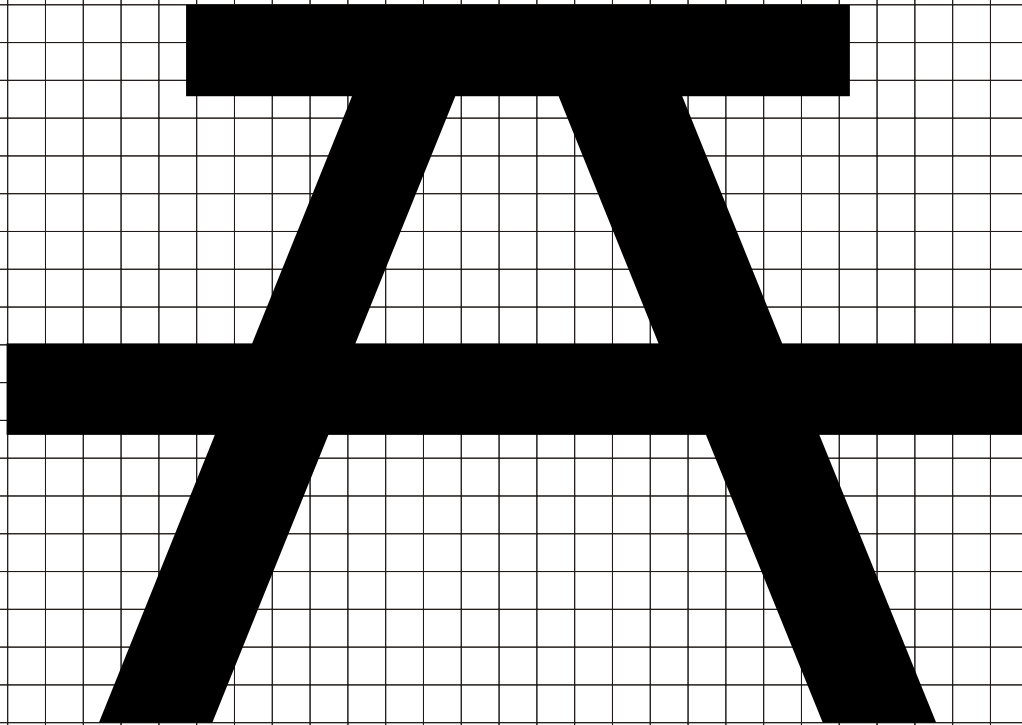

RS-044
Picnic Site

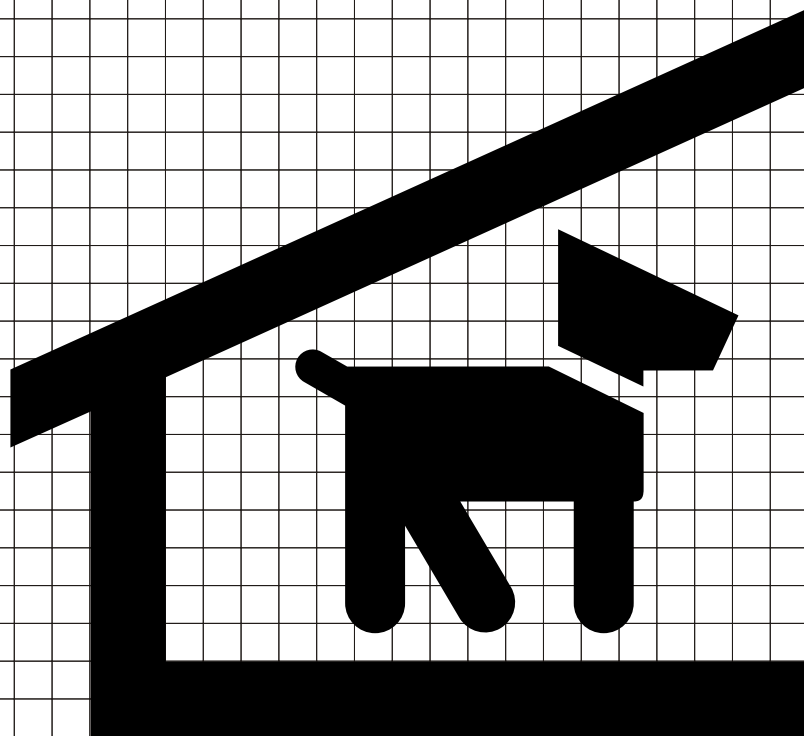

RS-045
Kennel

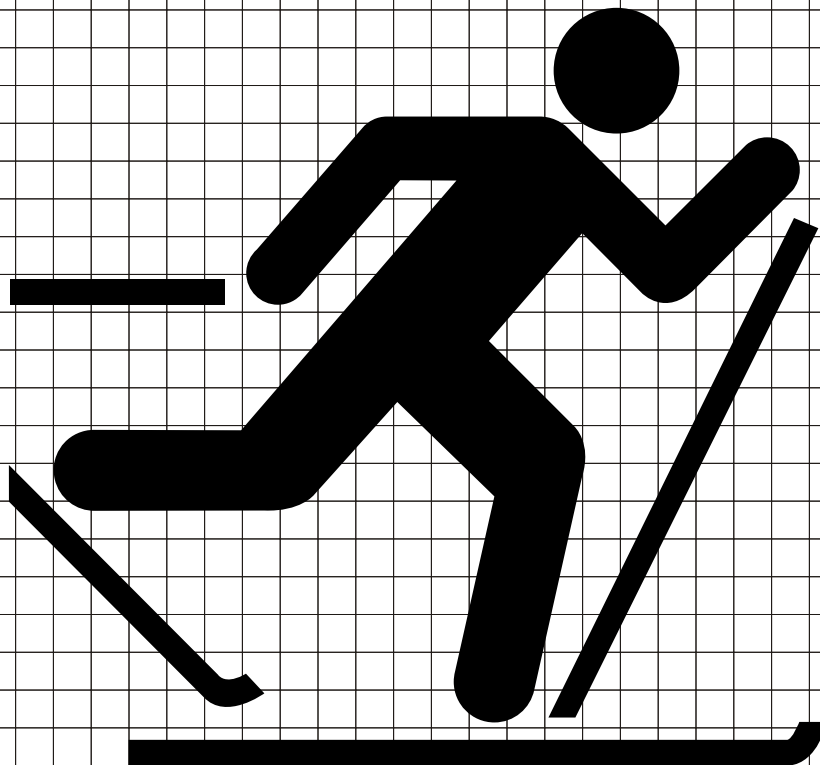

RS-046
Cross Country Skiing

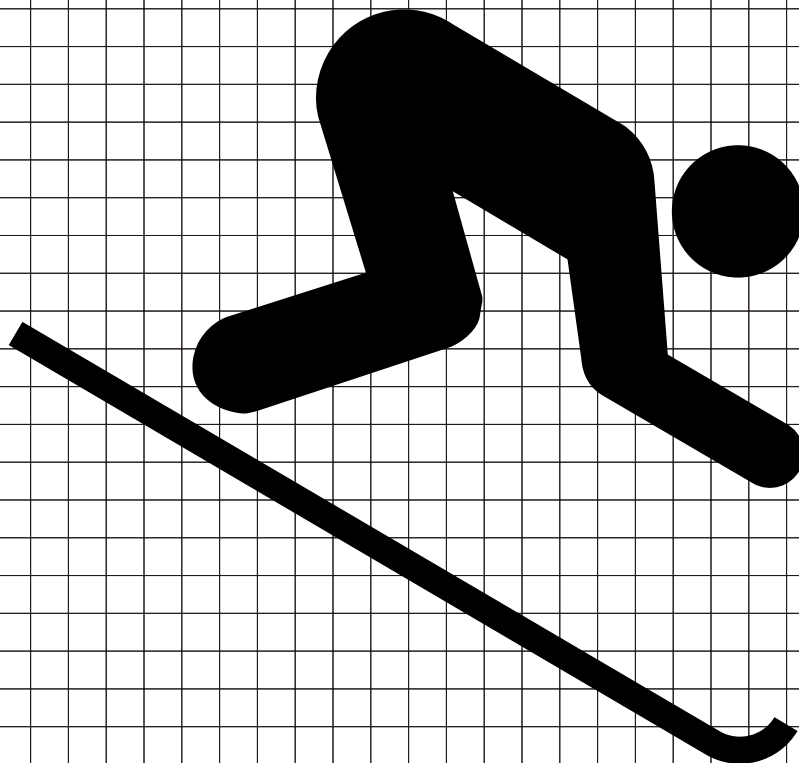

RS-047
Downhill Skiing

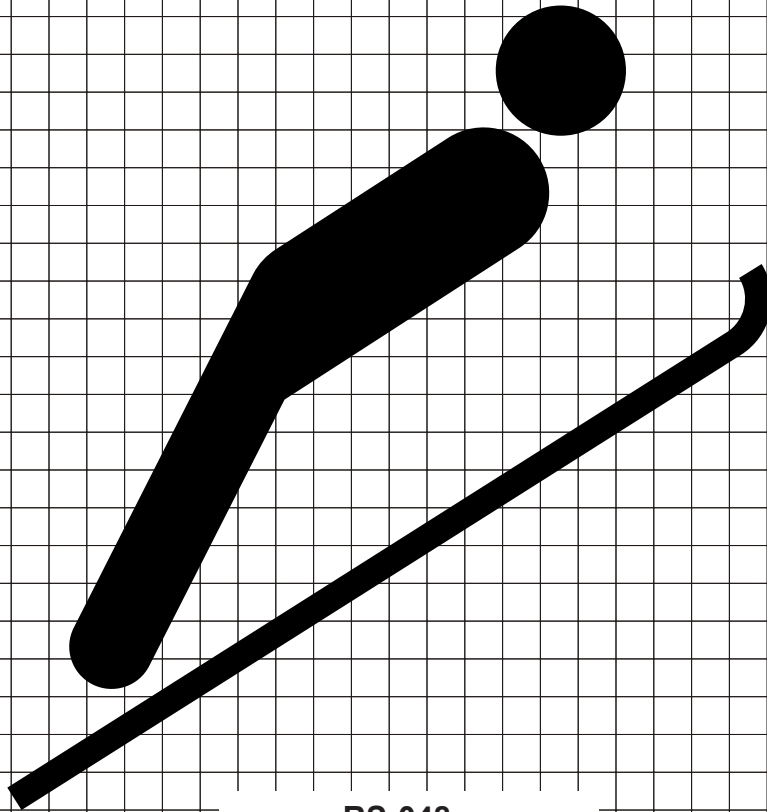

RS-048
Ski Jumping

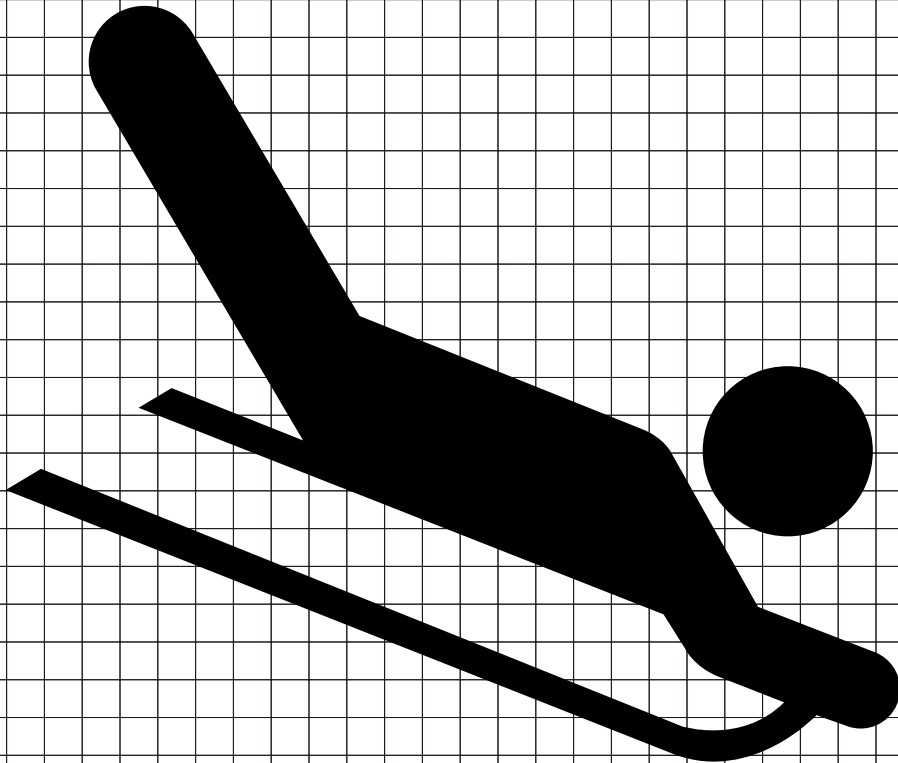

RS-049
Sledding

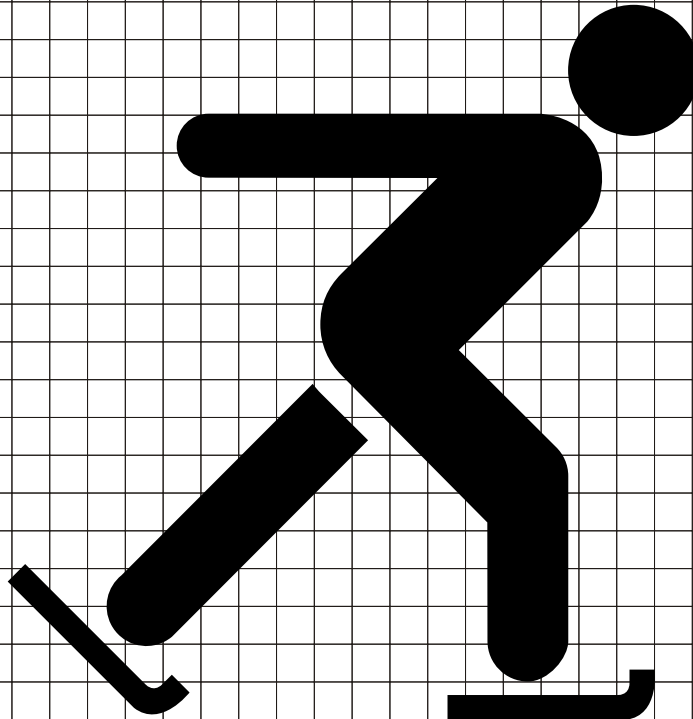

RS-050
Ice Skating

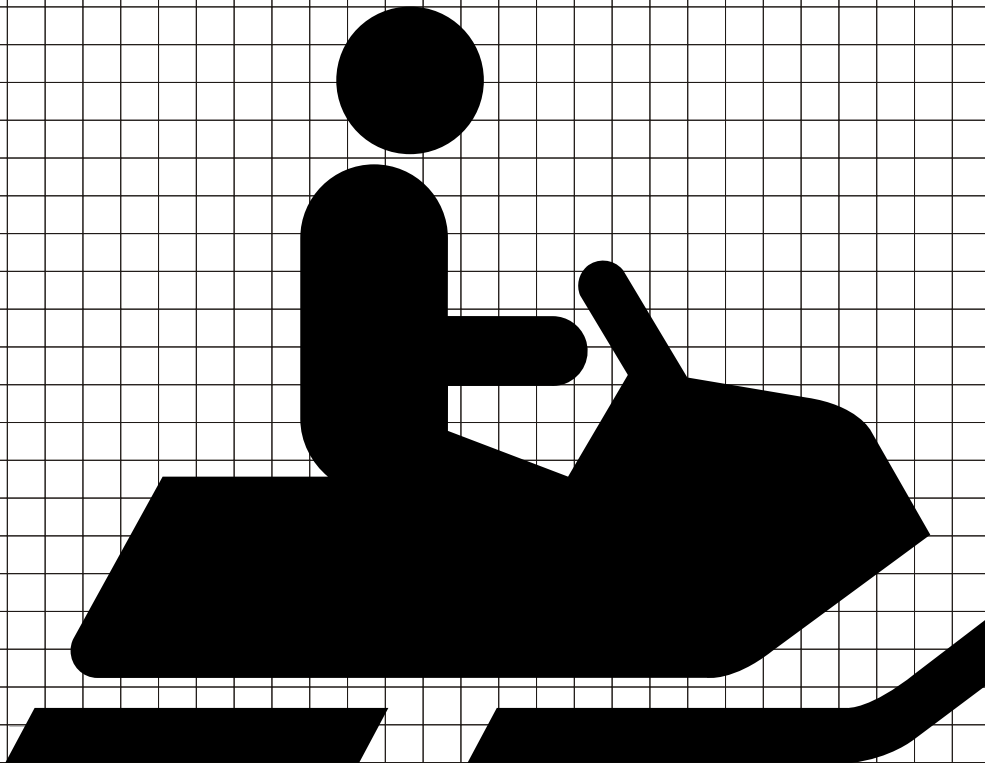

RS-052
Snowmobiling

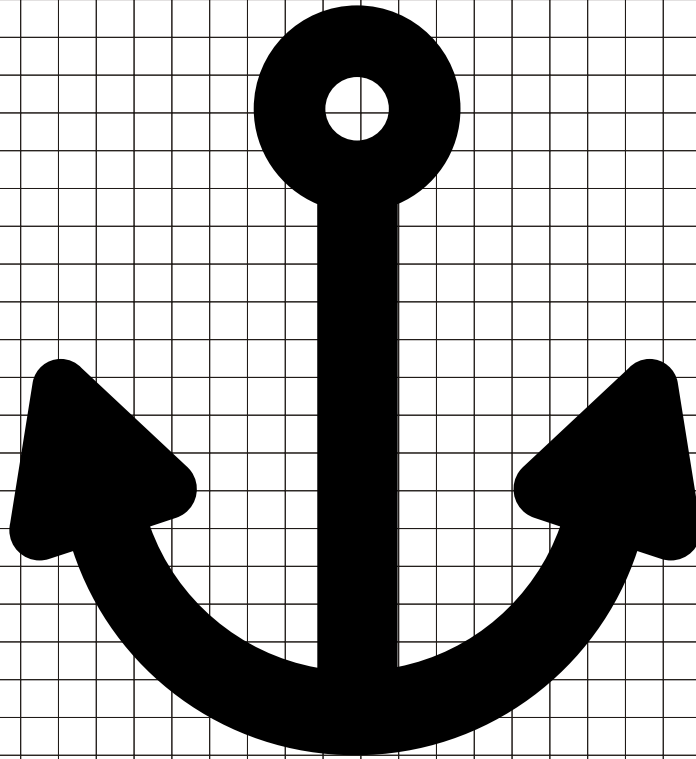

**RS-053
Marina**

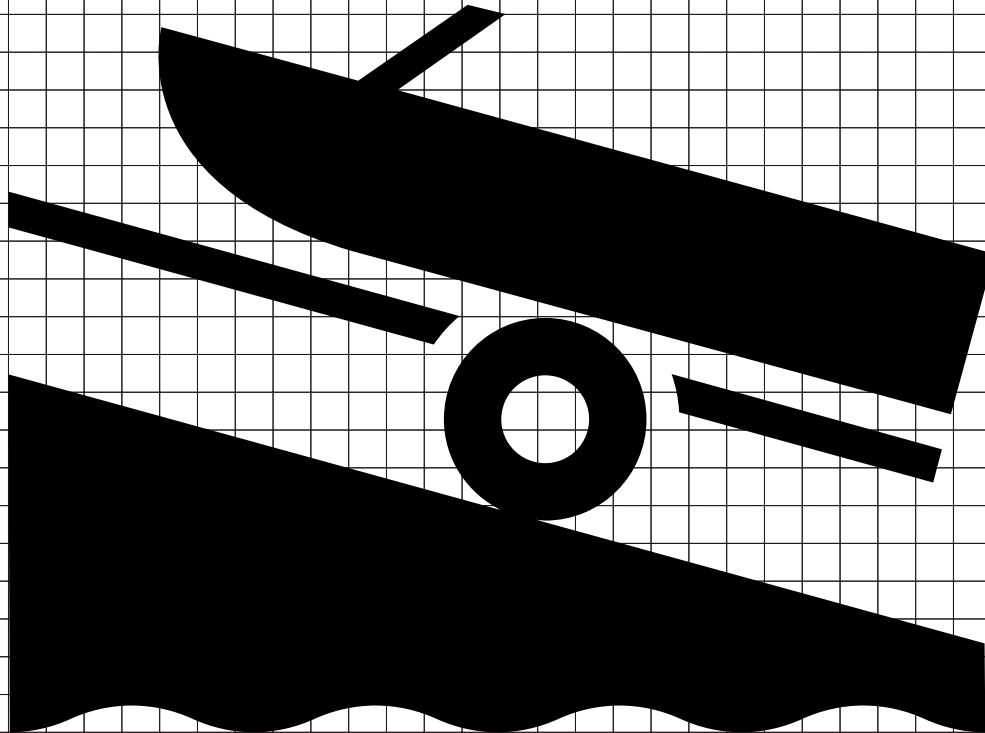

**RS-054
Boat Ramp**

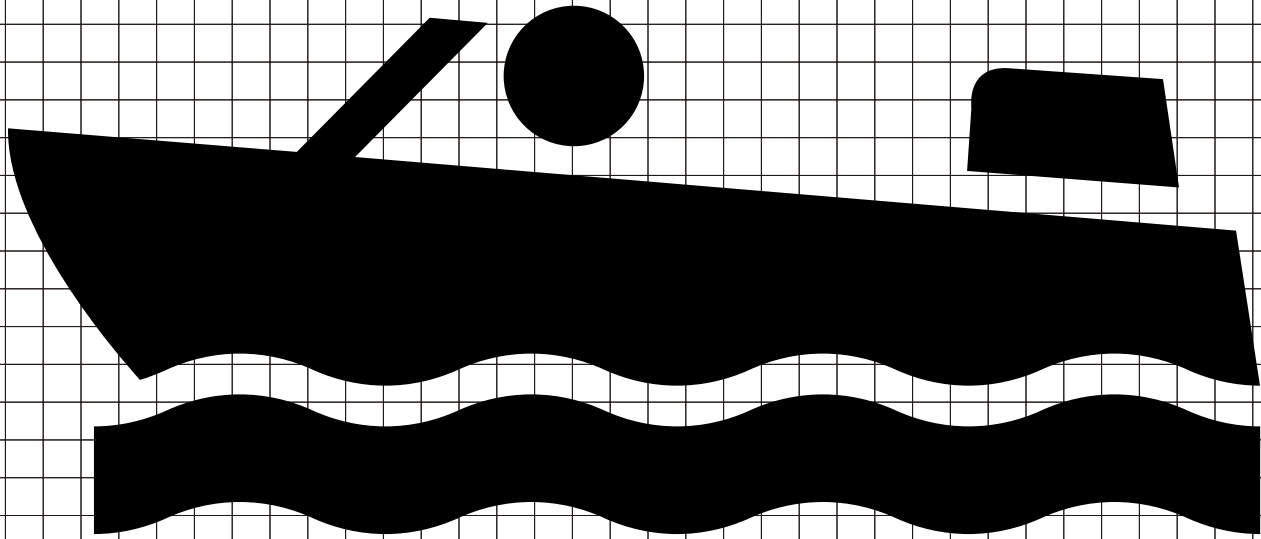

RS-055
Motorboating

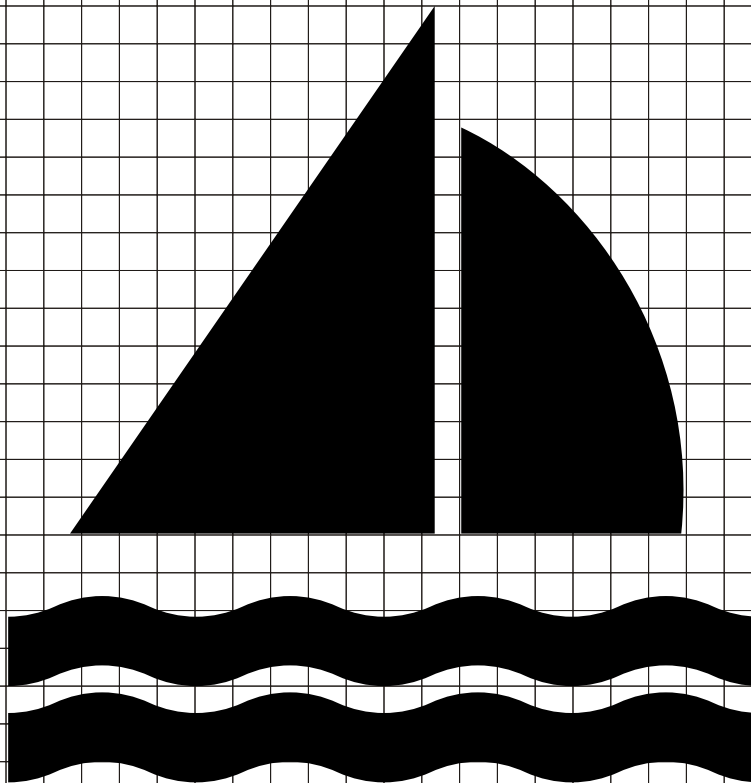

RS-056
Sailing

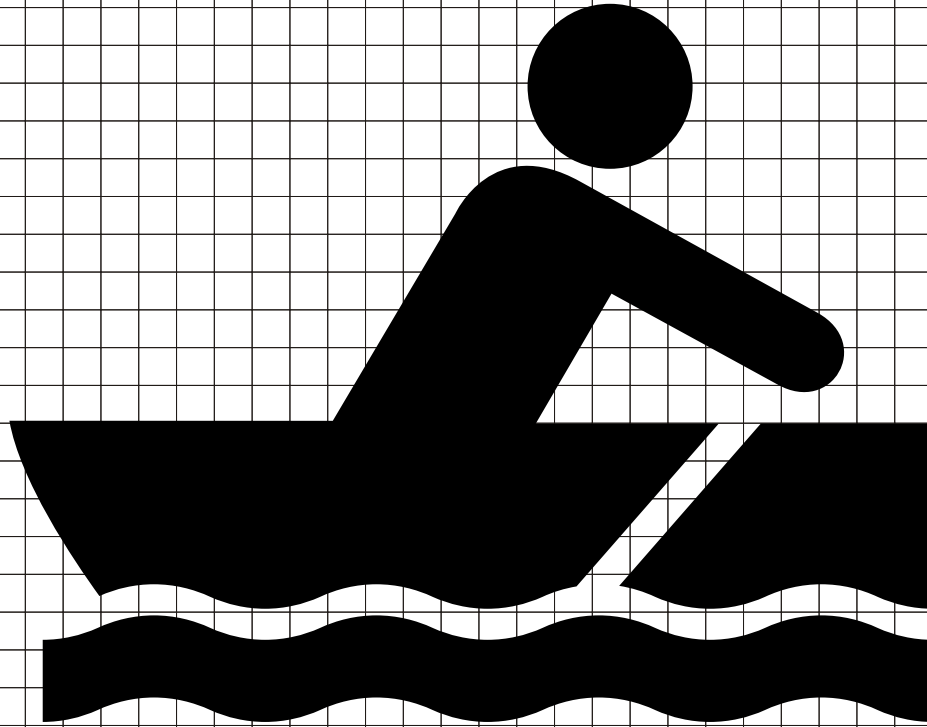

RS-057
Rowboating

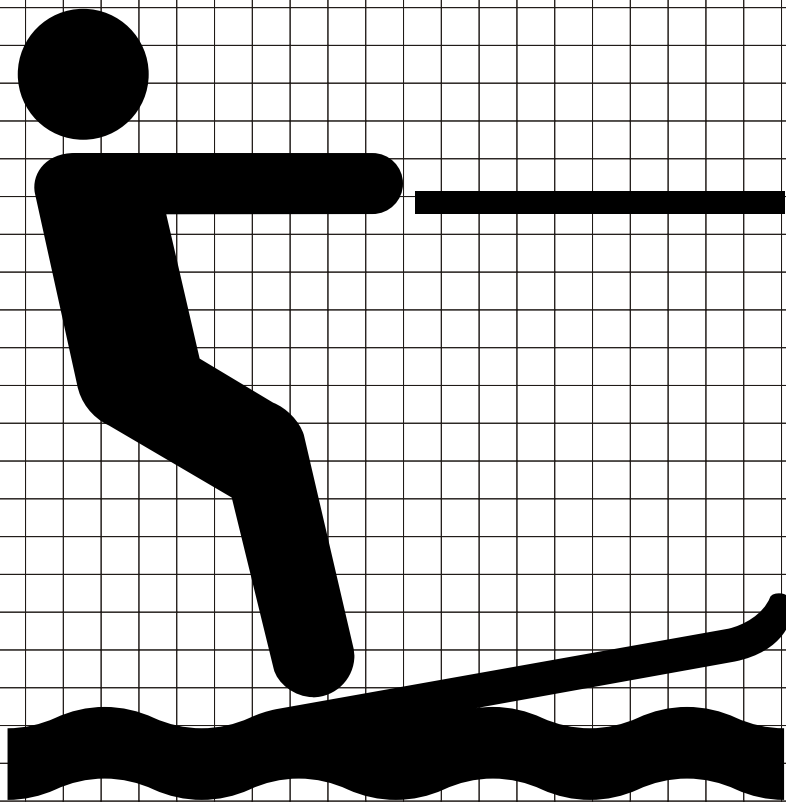

RS-058
Waterskiing

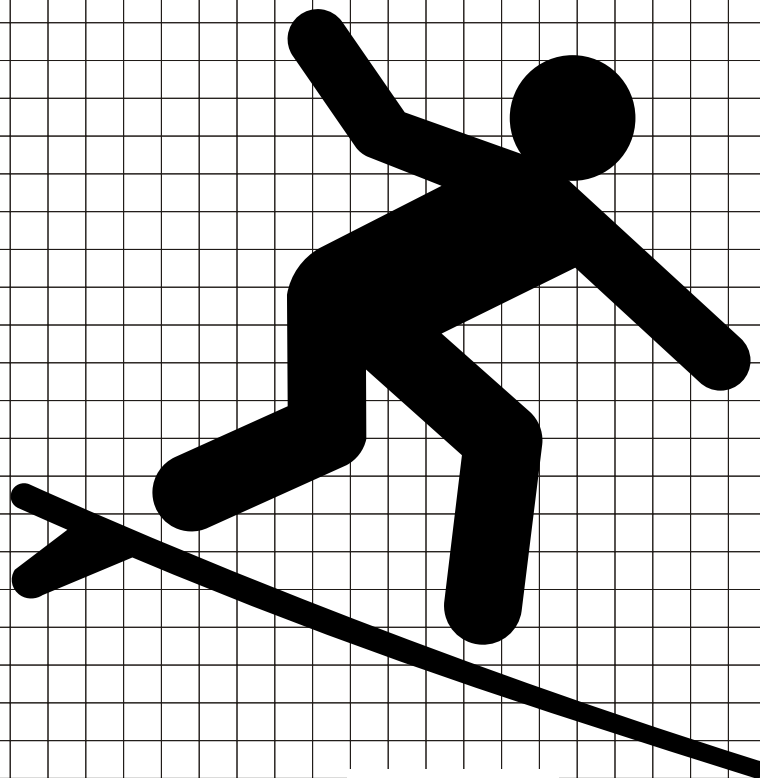

RS-059
Surfing

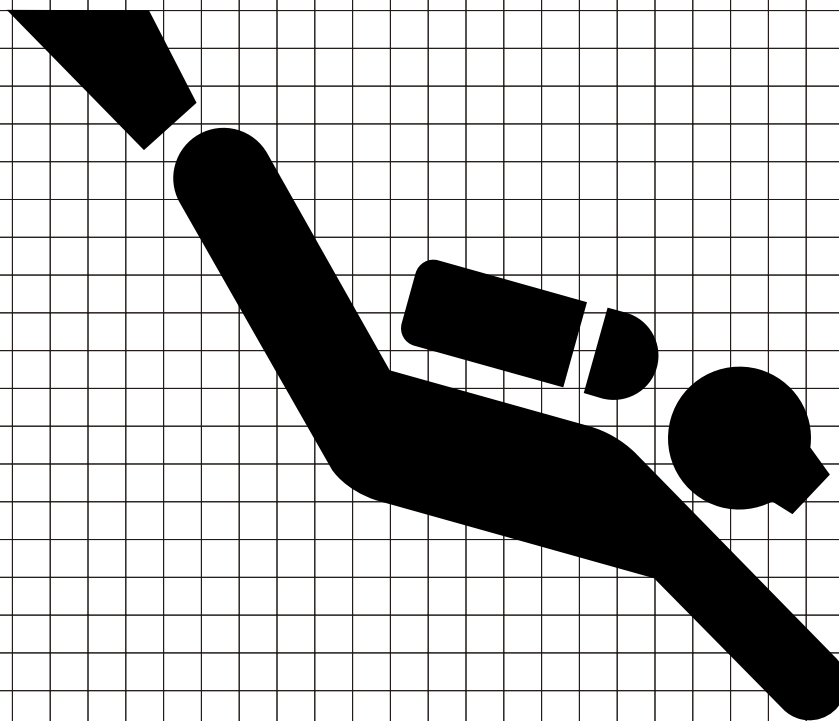

RS-060
Scuba Diving

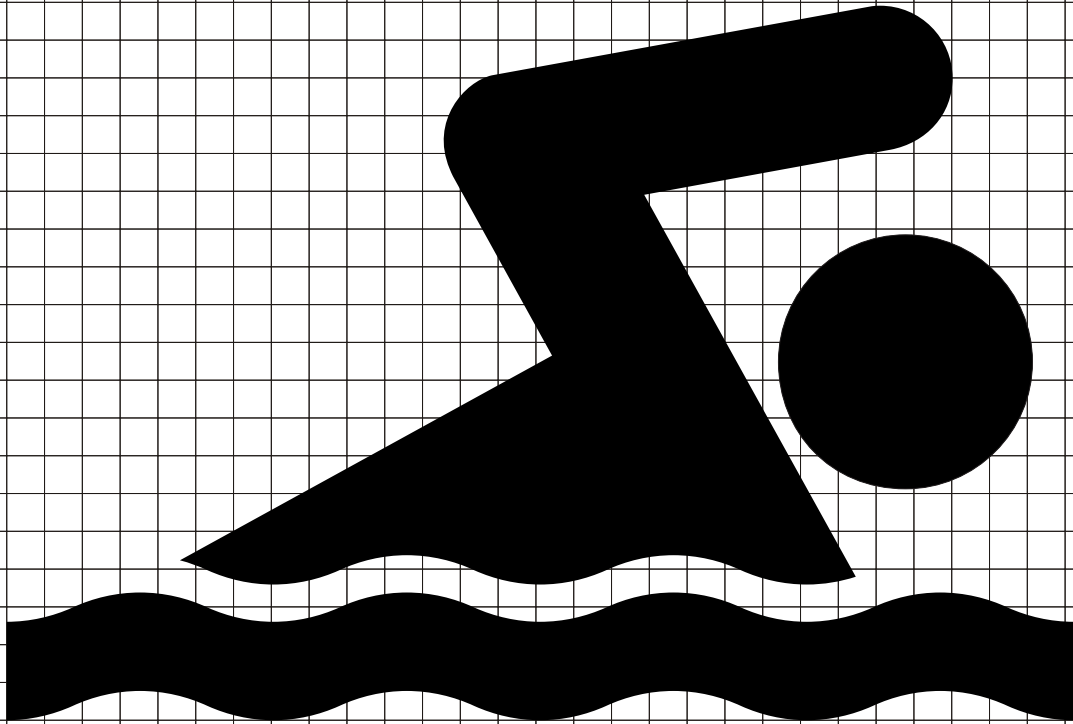

RS-061
Swimming

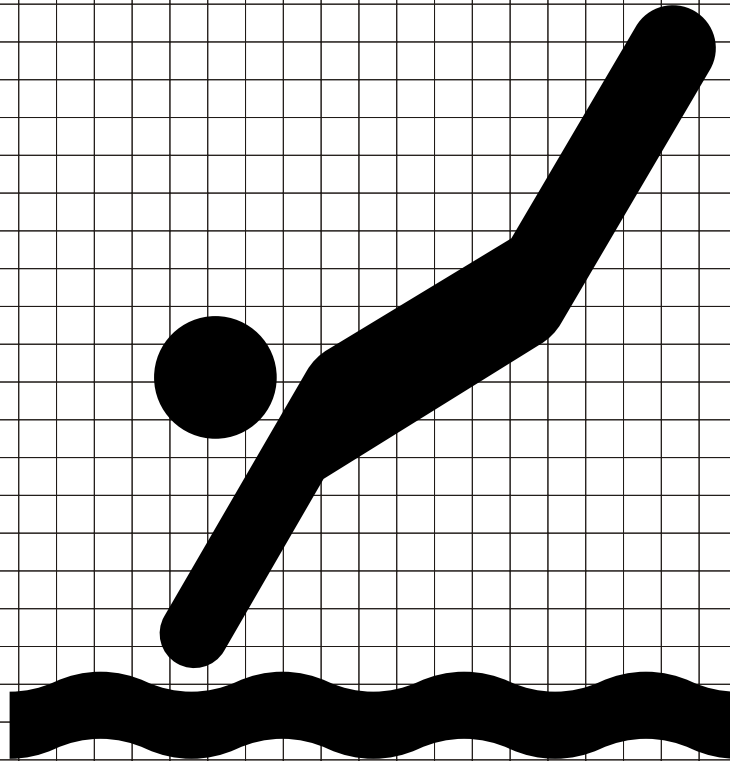

RS-062
Diving

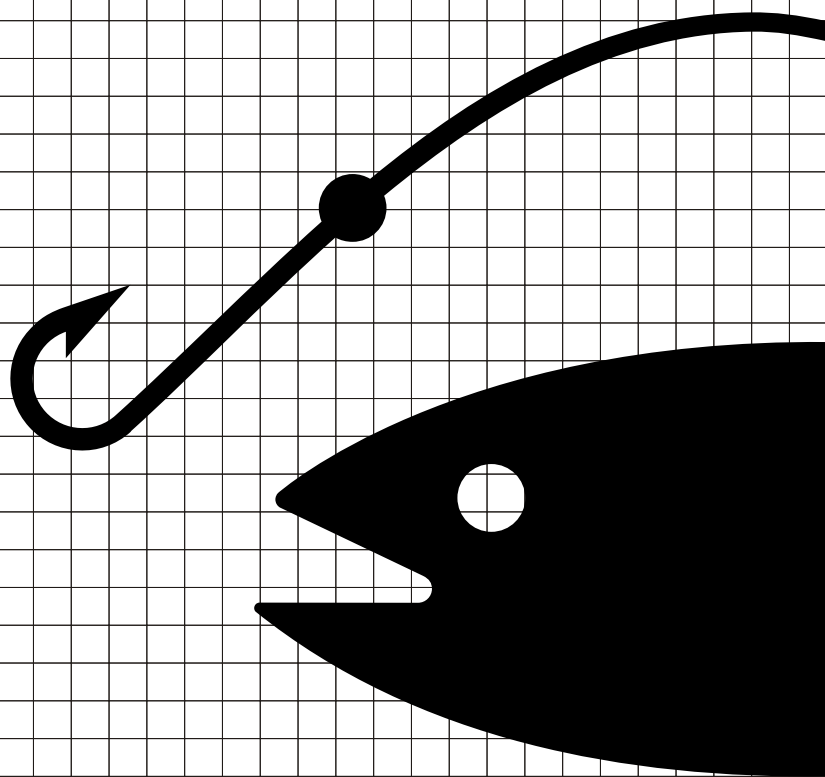

RS-063
Fishing Area

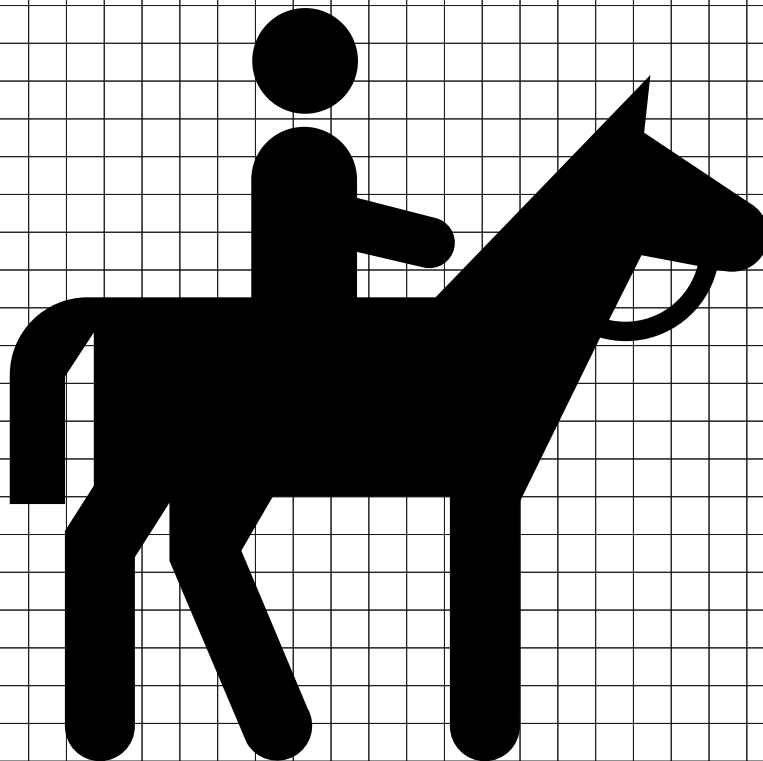

RS-064
Horse Trail

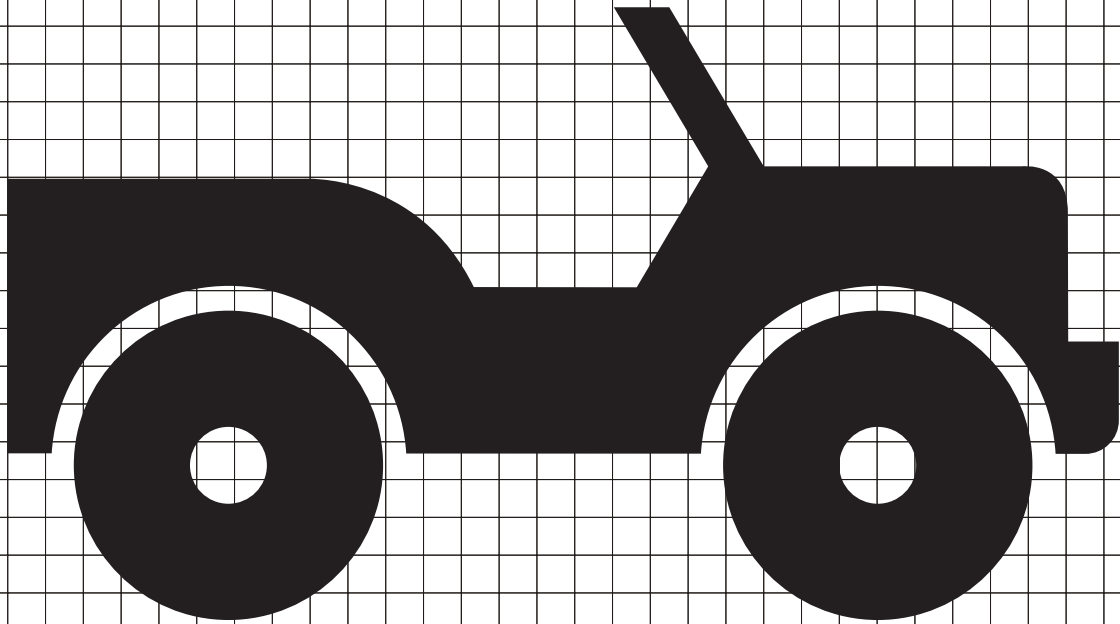

RS-067
Off-Road Vehicle Trail

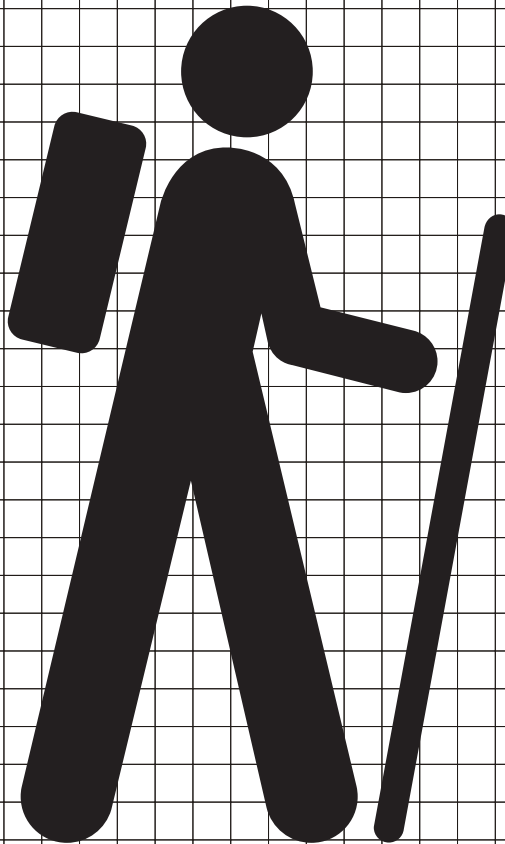

RS-068
Hiking Trail

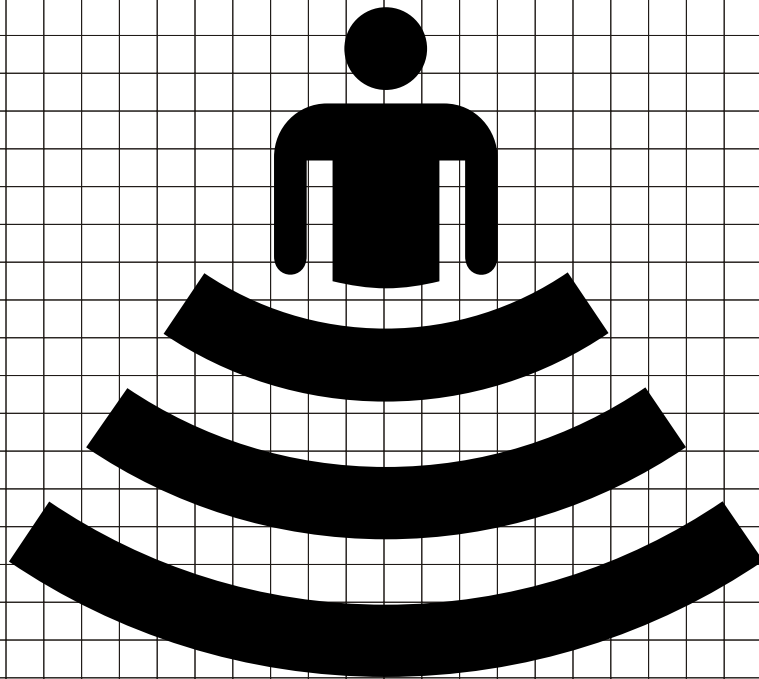

RS-070
Amphitheater

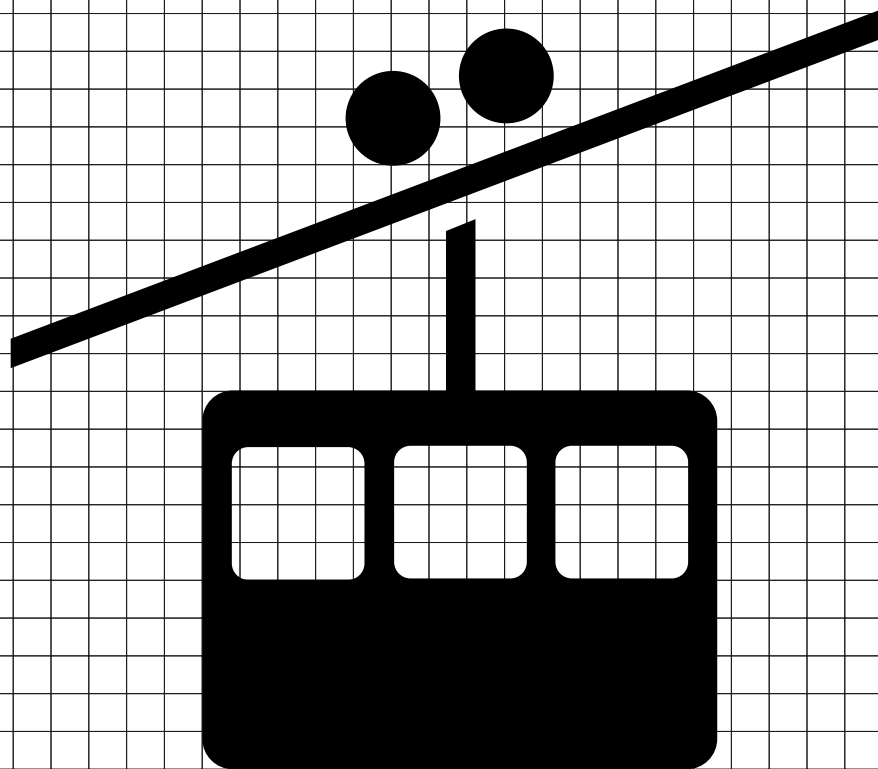

RS-071
Tramway

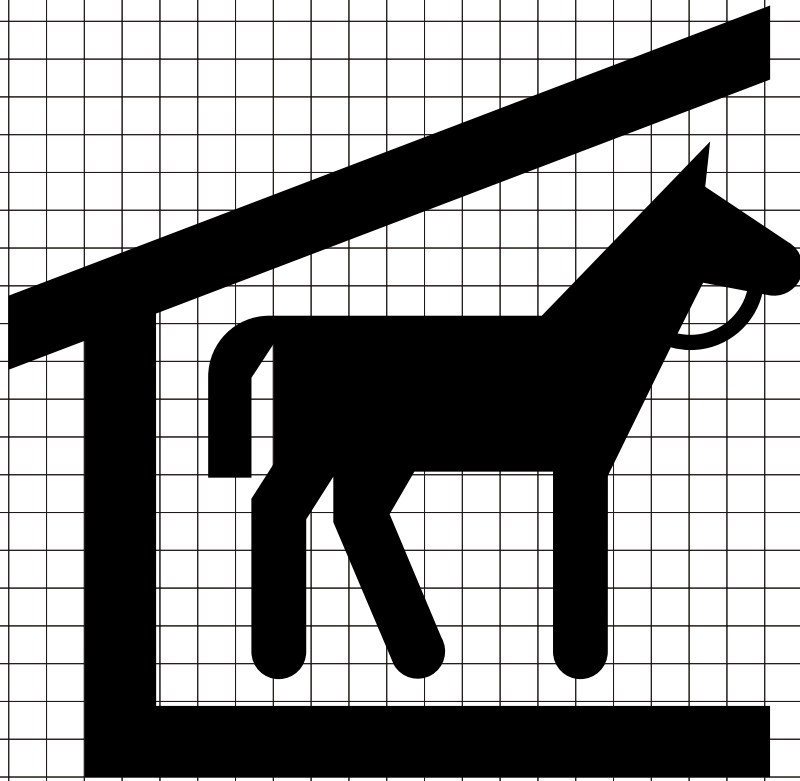

**RS-073
Stable**

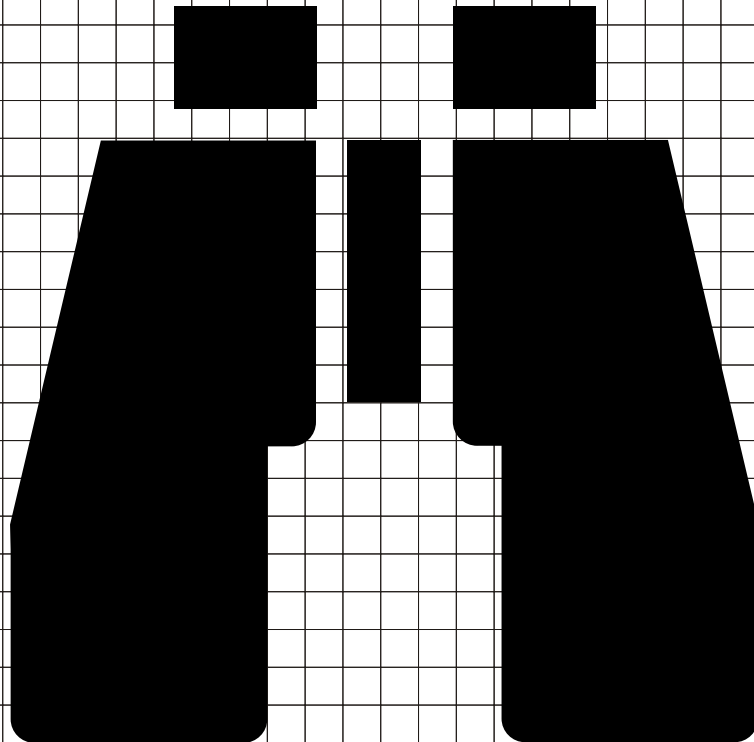

**RS-076
Wildlife Viewing**

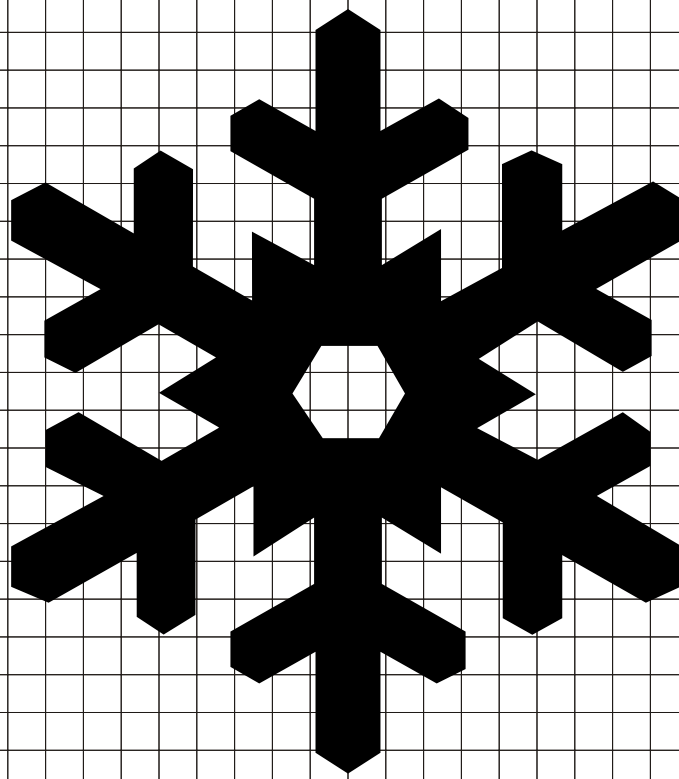

RS-077
Winter Recreational Area

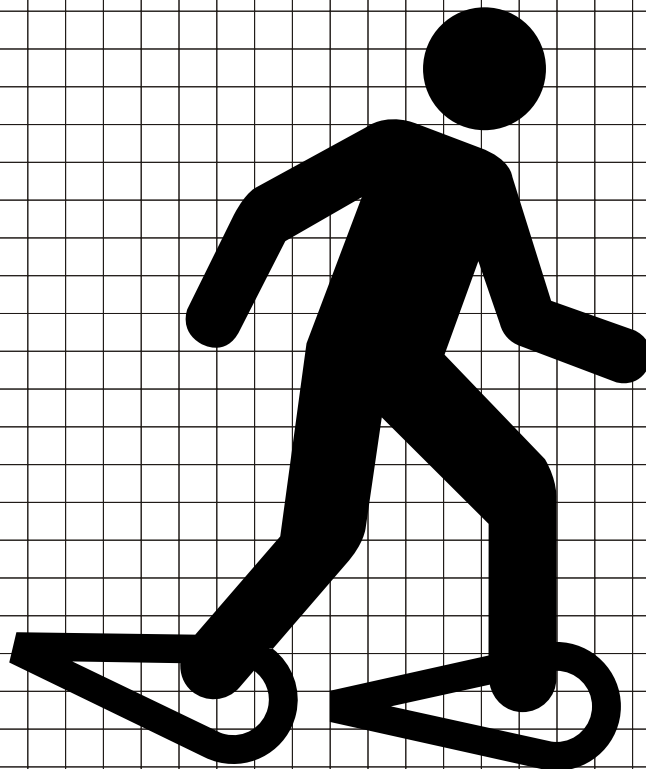

RS-078
Snowshoeing



RS-079
Canoeing

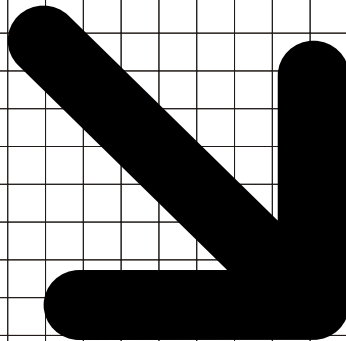

RS-080
Point of Interest

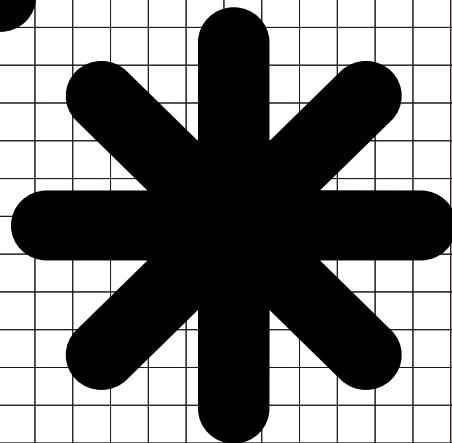

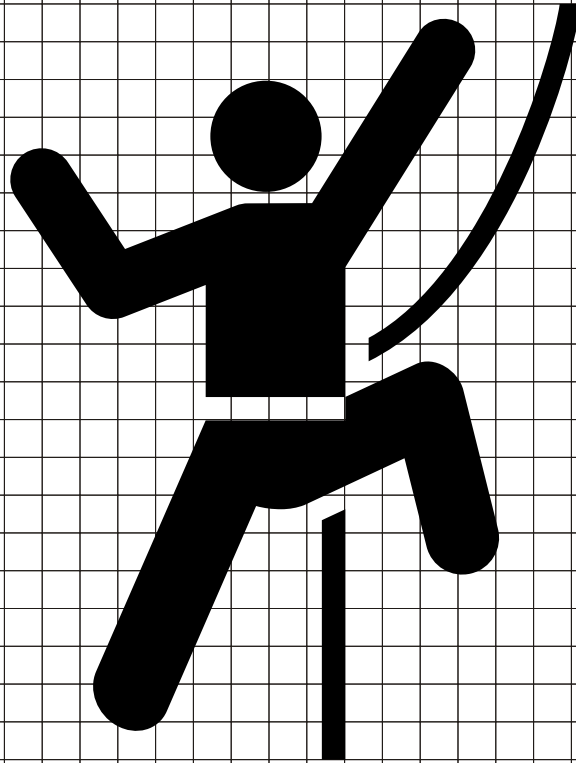

**RS-081 Technical
Rock Climbing**

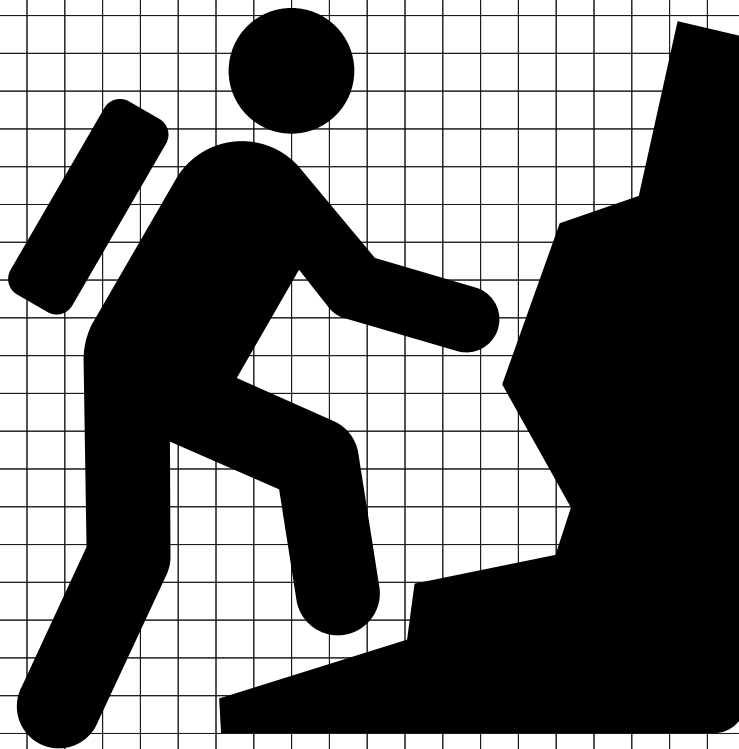

**RS-082
Climbing**

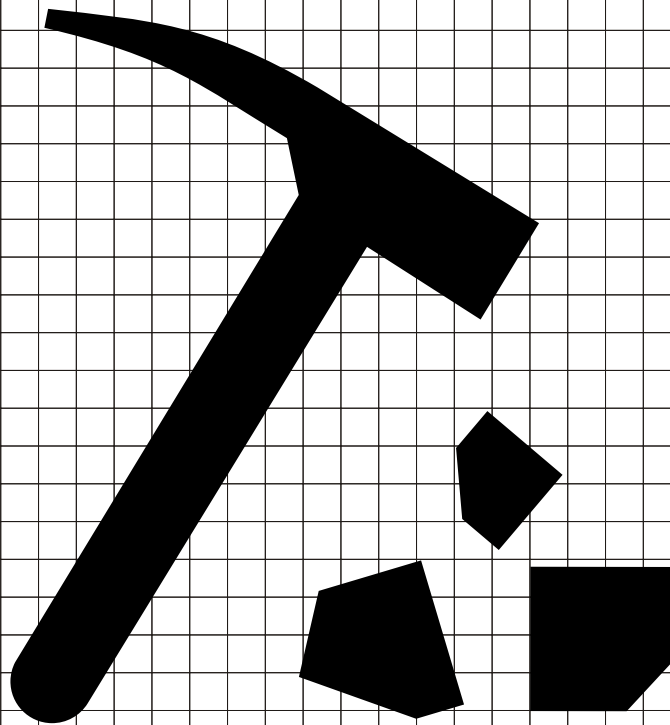

RS-083
Rock Collecting

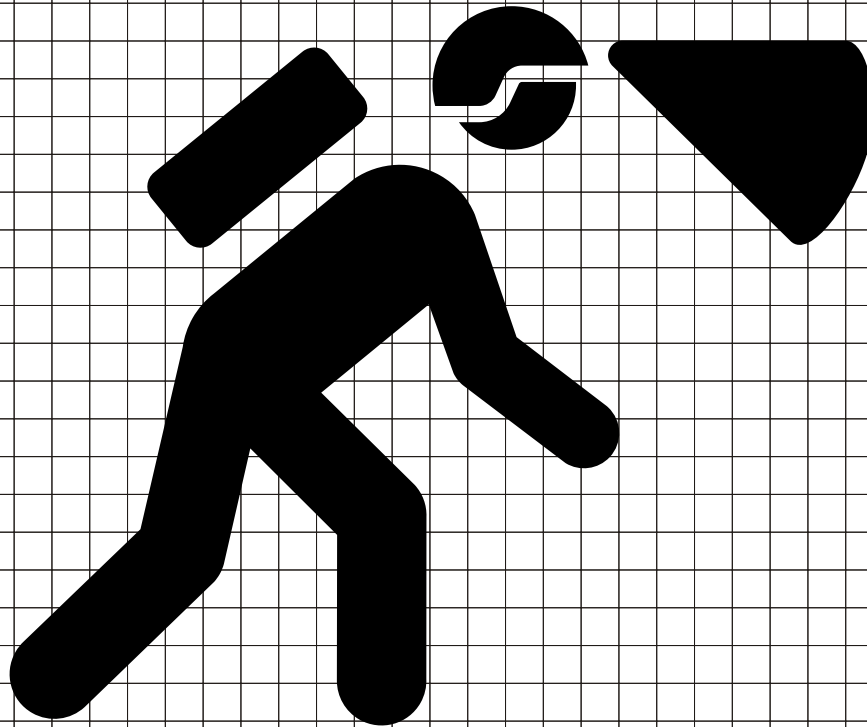

RS-084
Spelunking/Caves

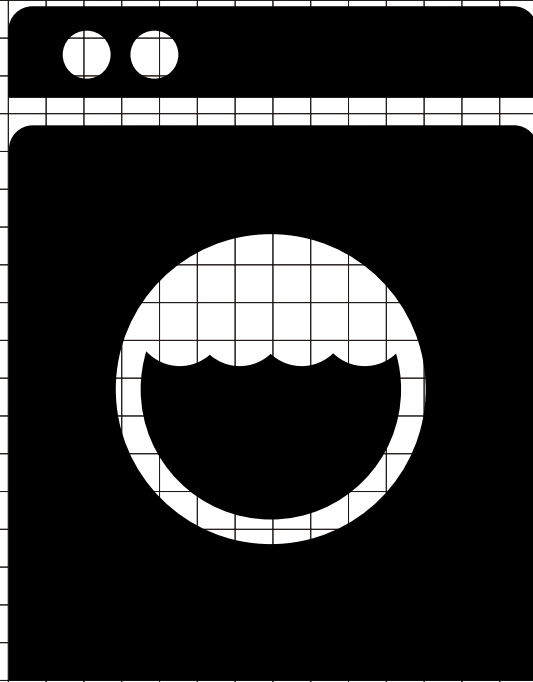

RS-085
Laundromat

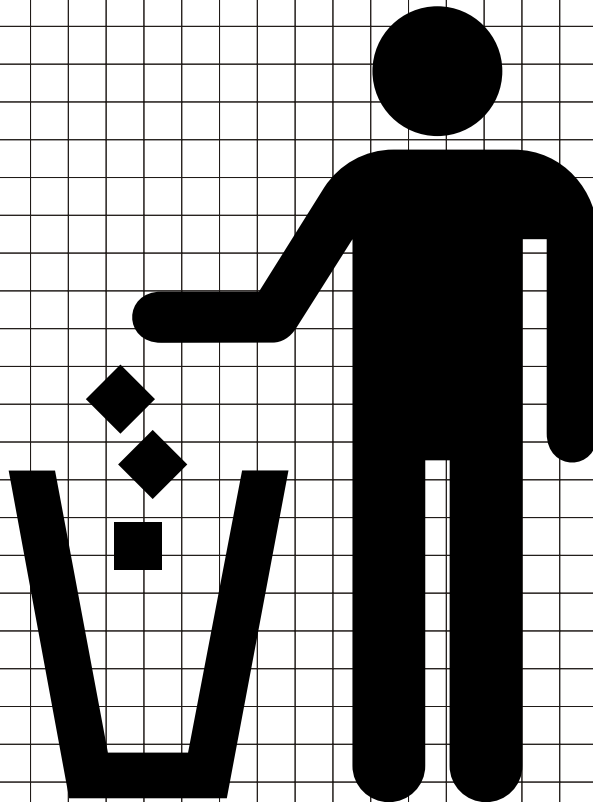

RS-086
Litter Receptacle

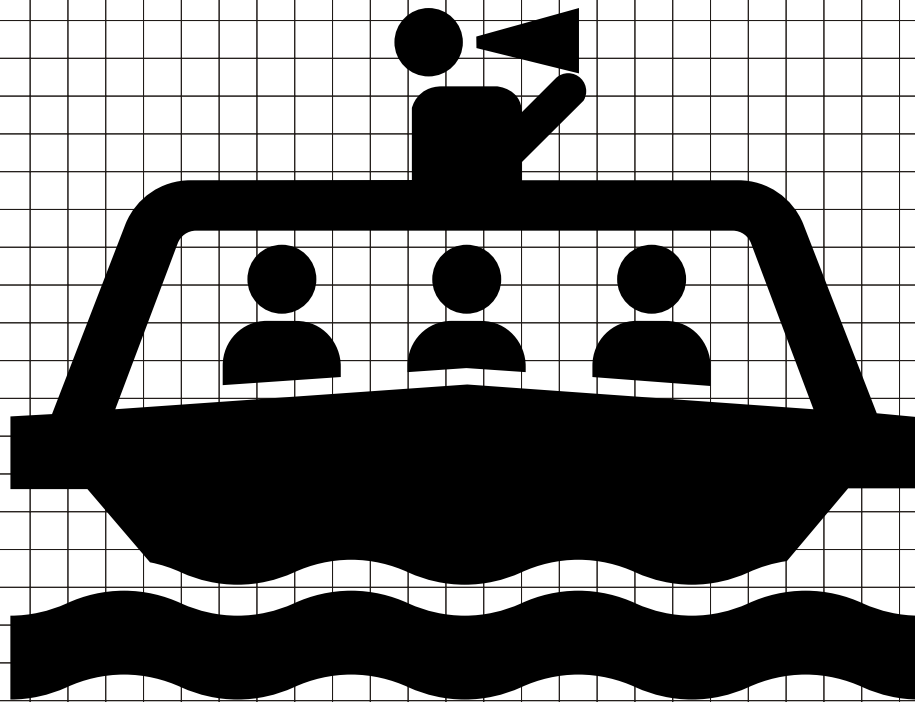

RS-087
Tour Boat

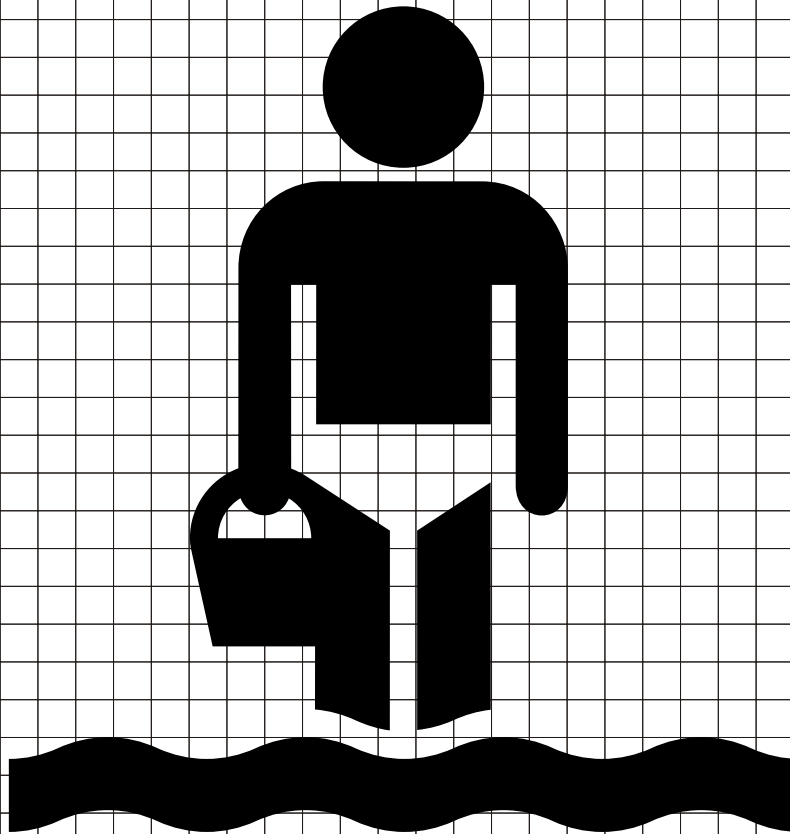

RS-088
Wading

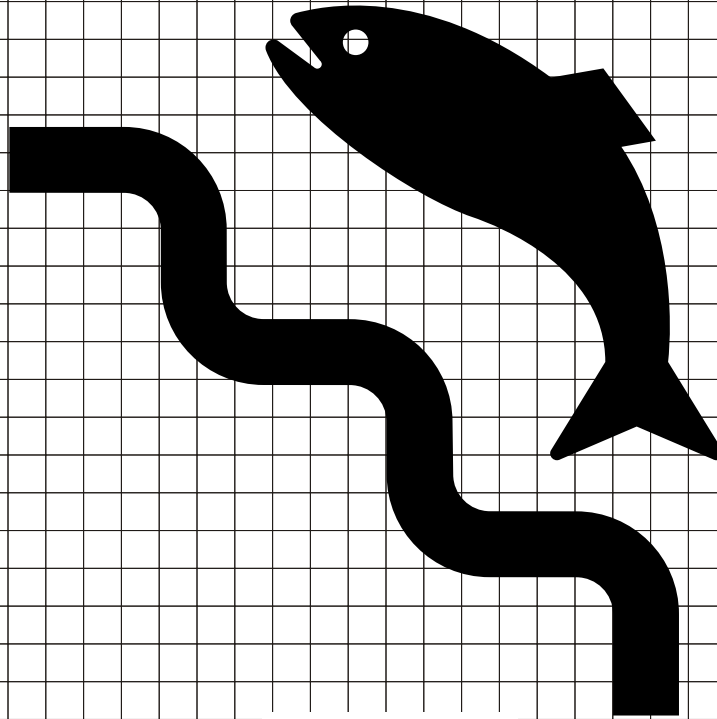

RS-089
Fish Ladder

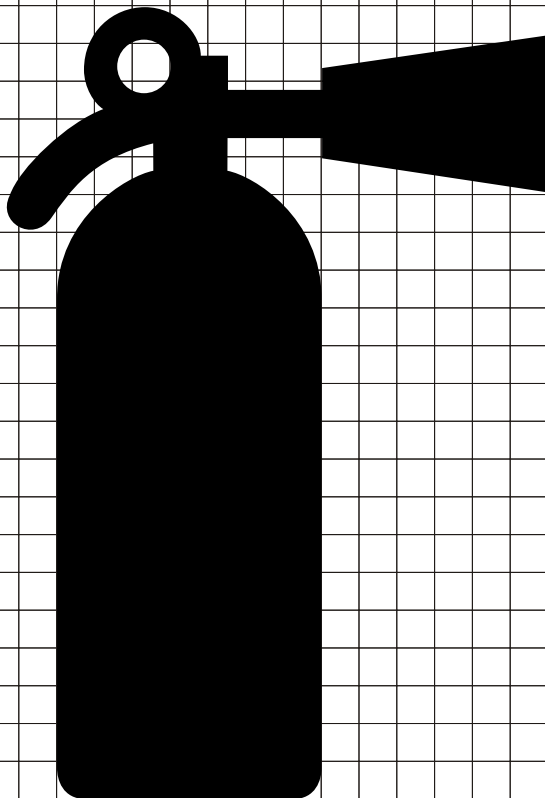

RS-090
Fire Extinguisher



RS-091
Trash Dumpster

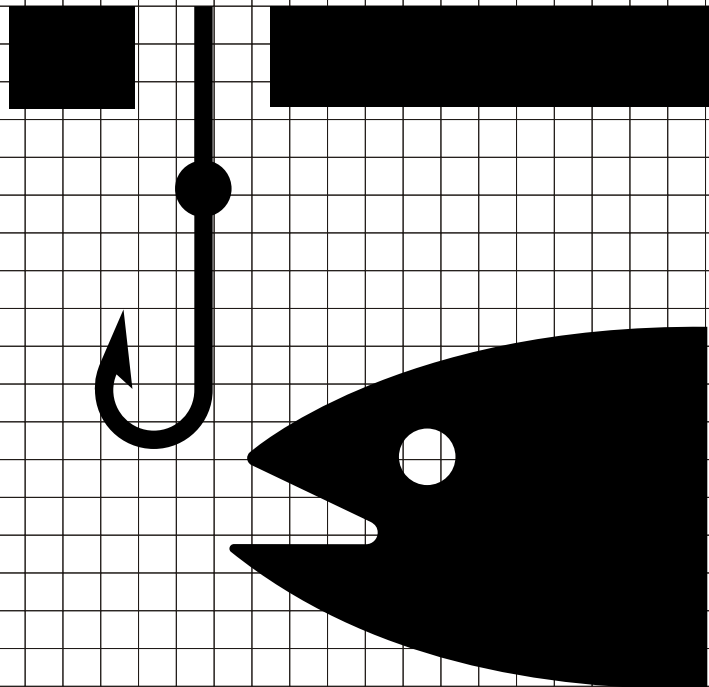

RS-092
Ice Fishing

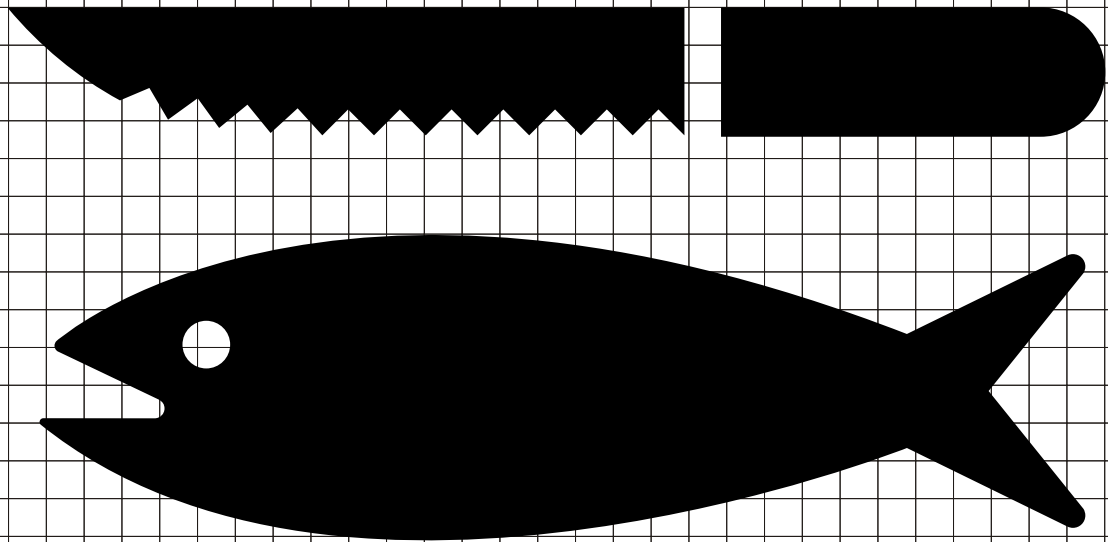

RS-093
Fish Cleaning

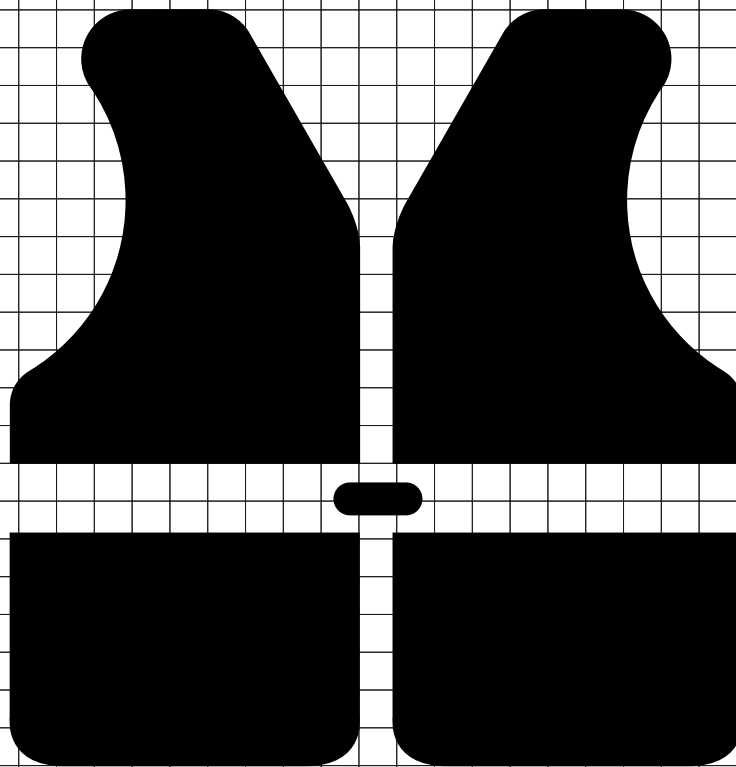

RS-094
Lifejackets

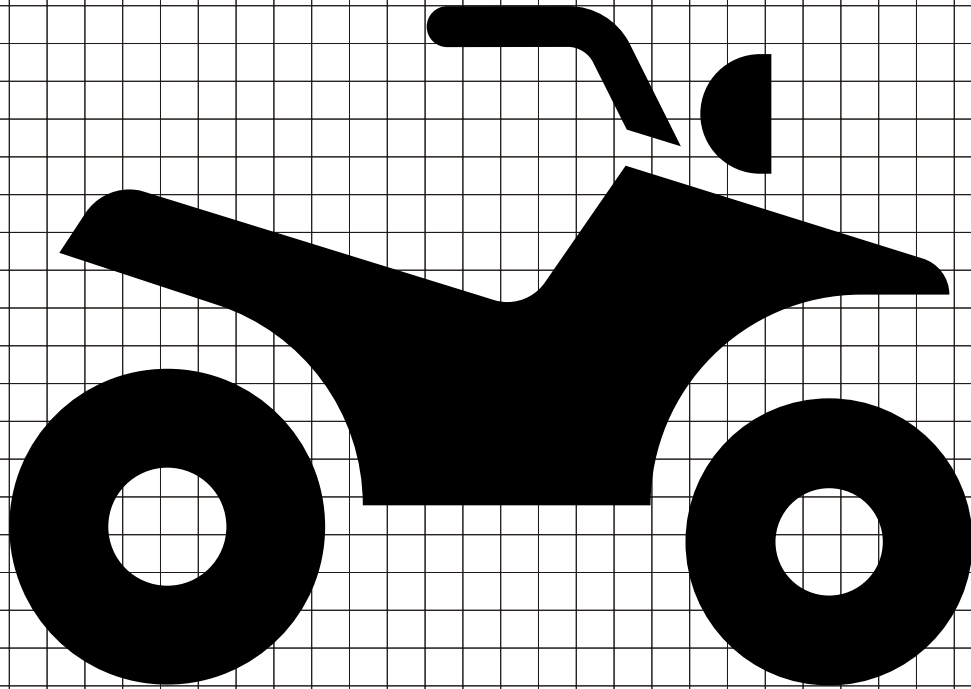

**RS-095
All-Terrain Trail**

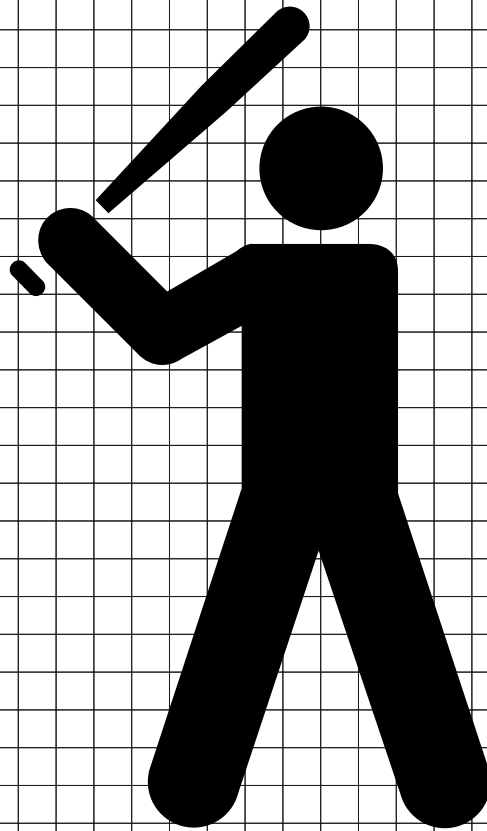

**RS-096
Baseball**

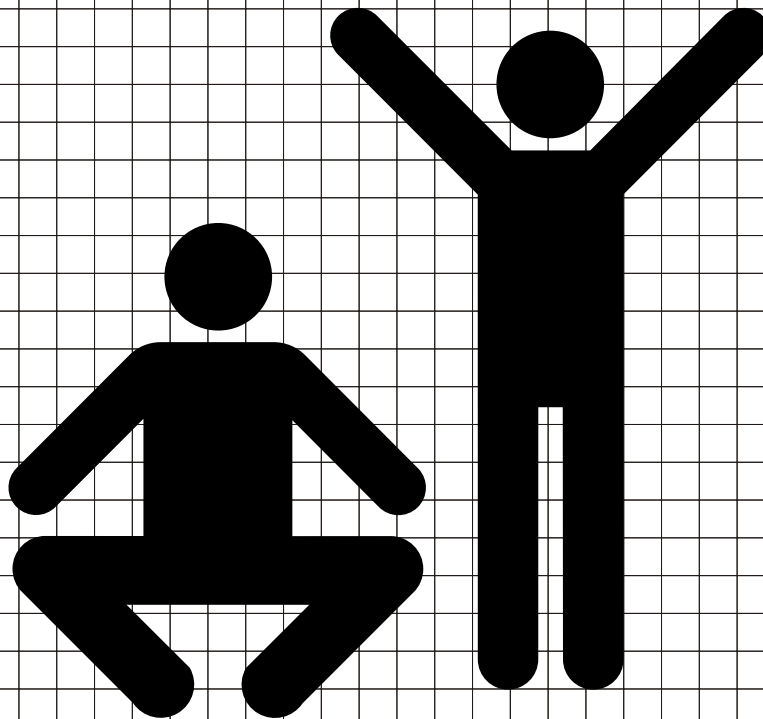

RS-097
Exercise/Fitness

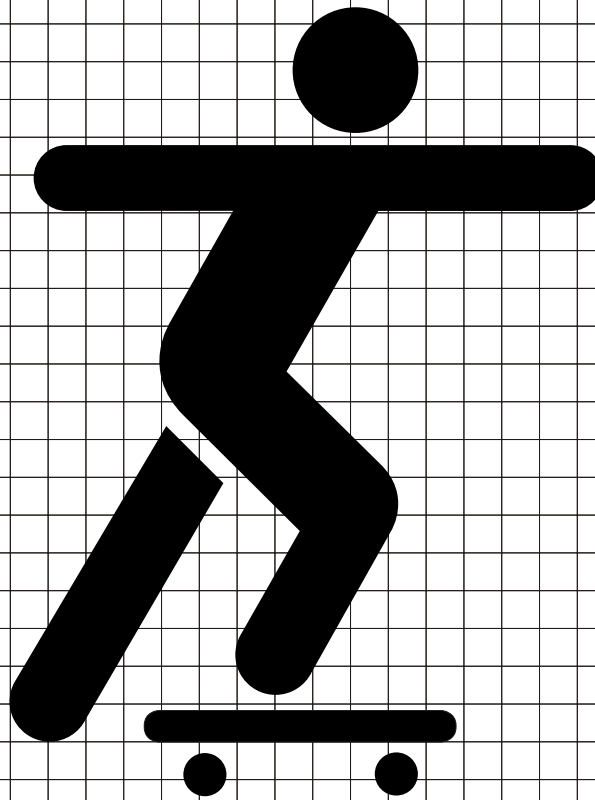

RS-098
Skateboarding

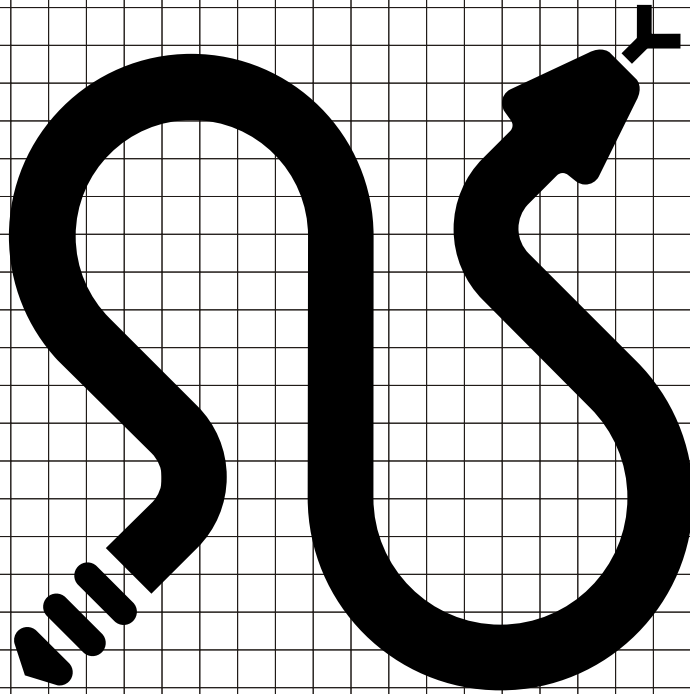

RS-099
Rattlesnakes

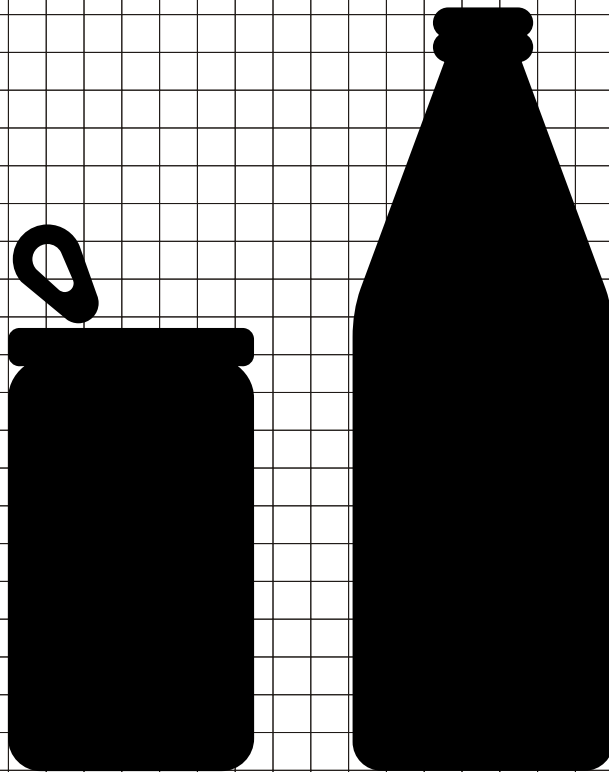

RS-101
Cans or Bottles

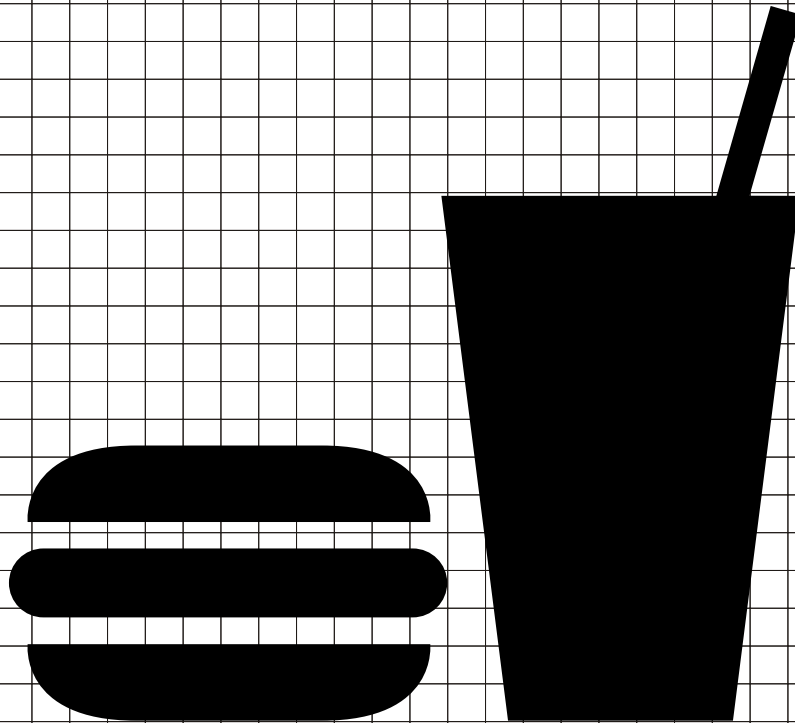

**RS-102
Snack Bar**

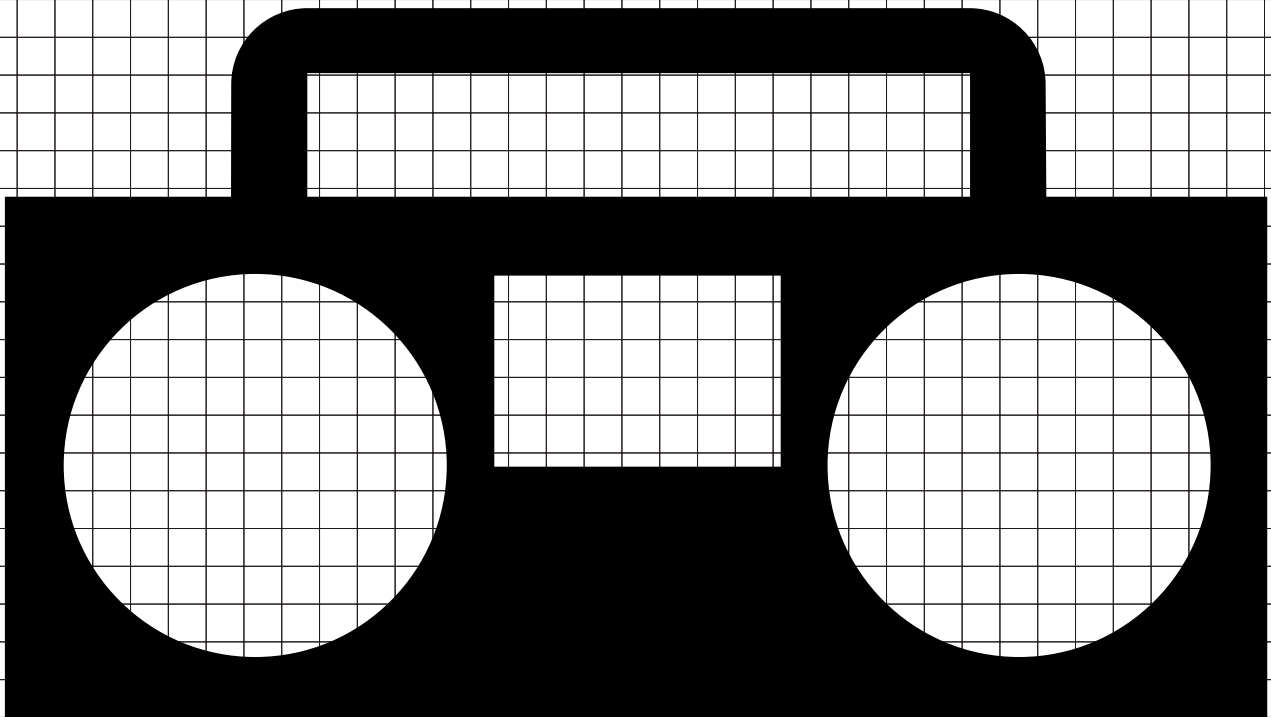

**RS-103
Radios**

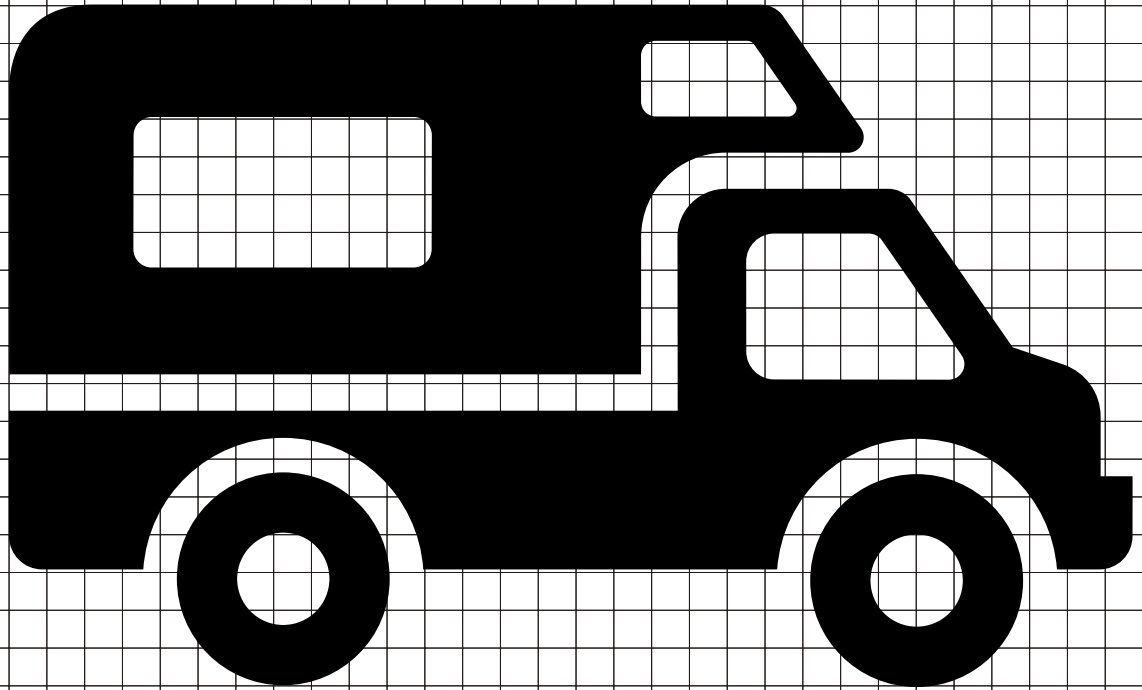

RS-104
Recreational Vehicle
Site

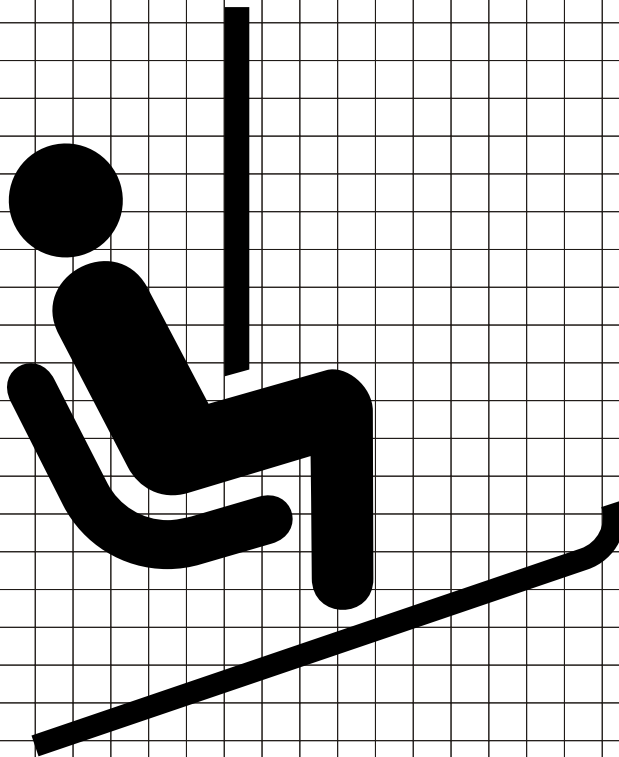

RS-105
Chair Lift/Ski Lift

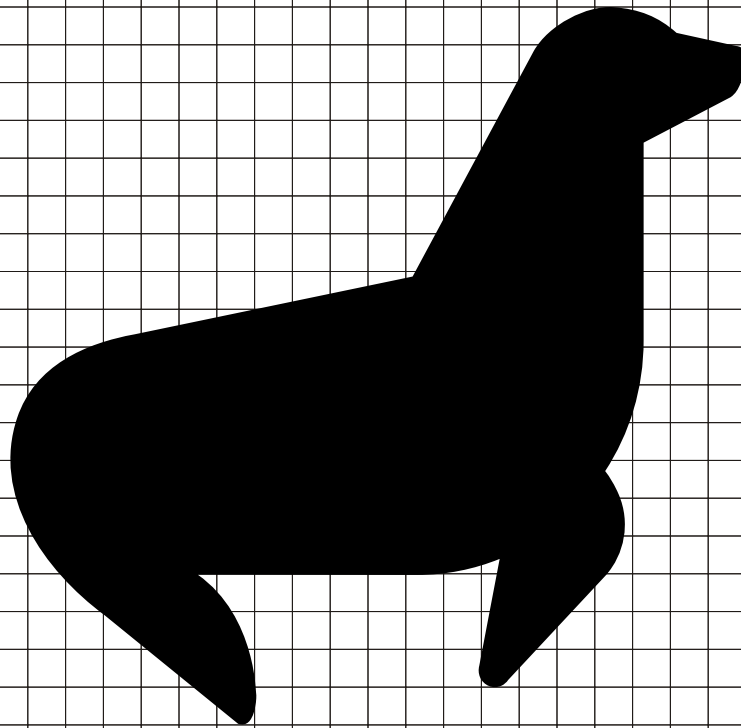

RS-106
Seal Viewing

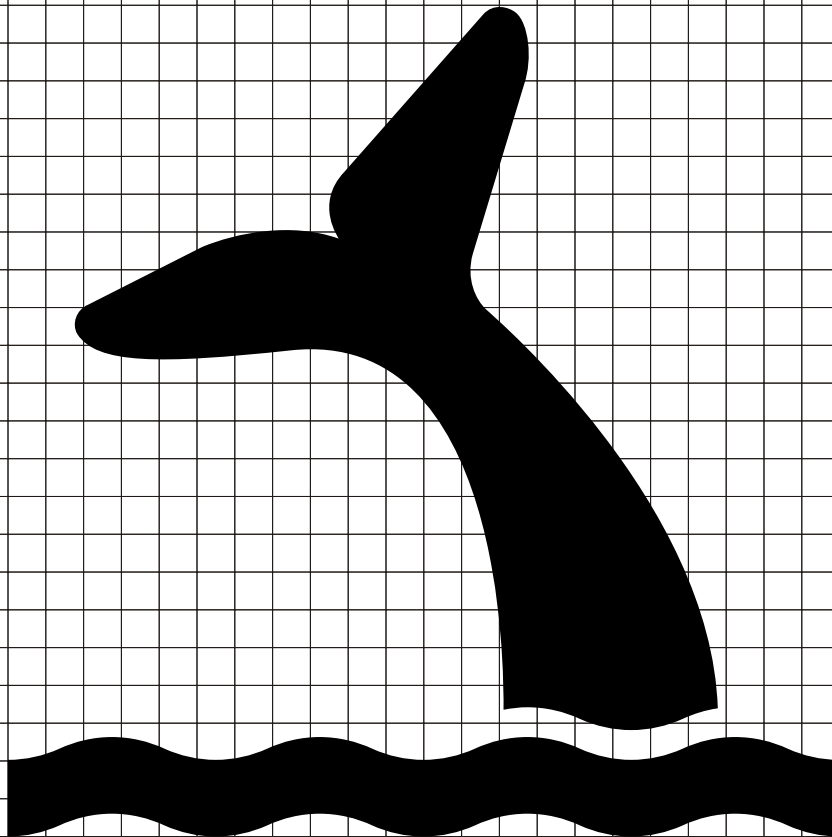

RS-107
Whale Viewing

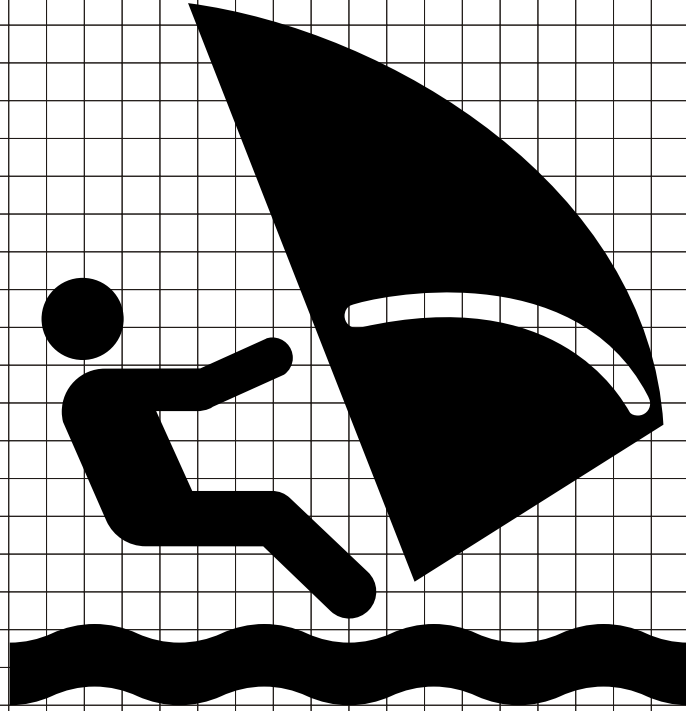

RS-108
Wind Surfing

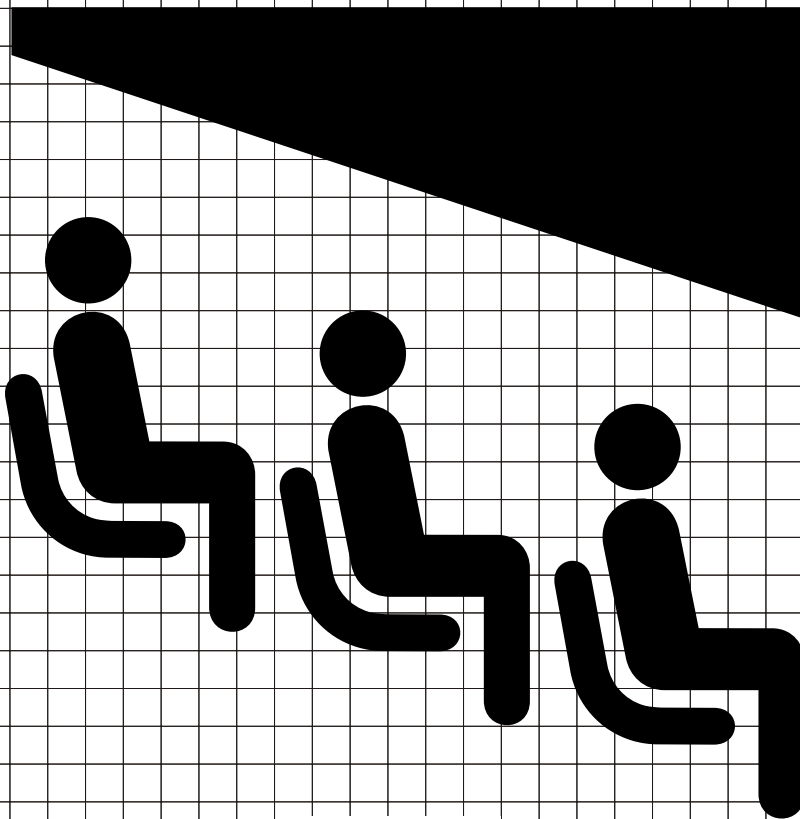

RS-109
Theater

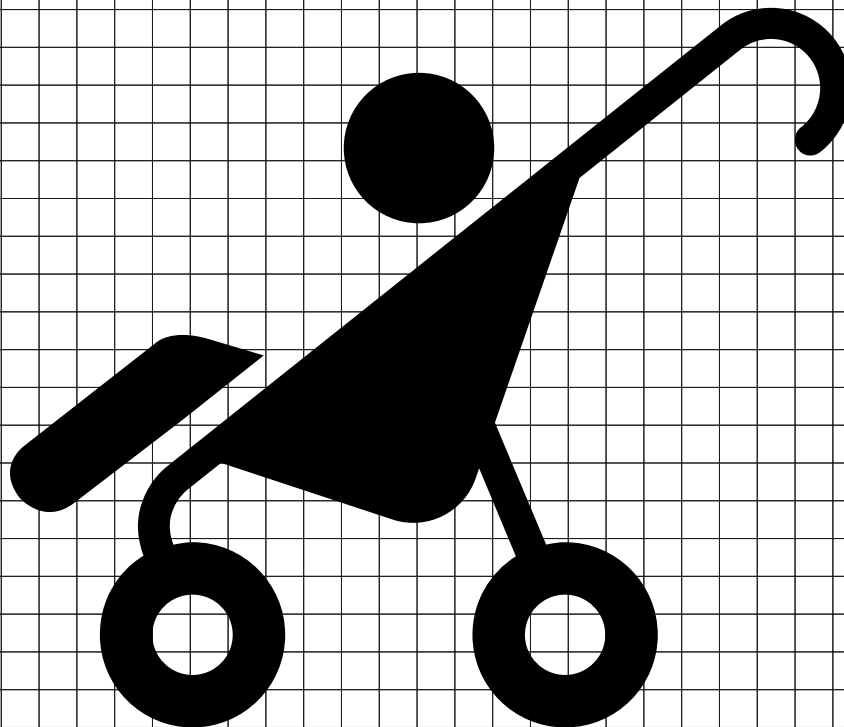

**RS-111
Strollers**

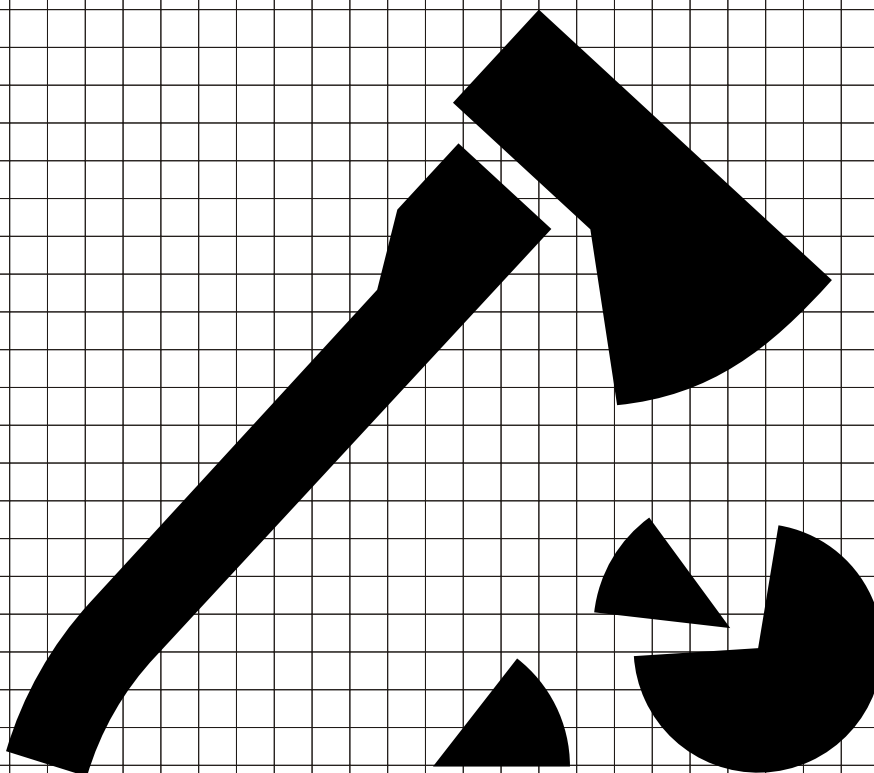

**RS-112
Firewood Cutting**

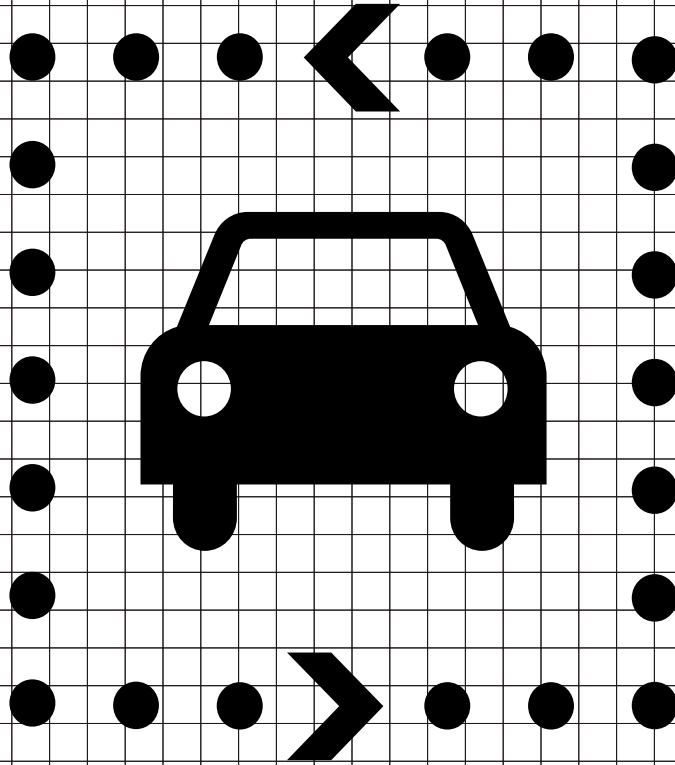

RS-113
Driving Tour

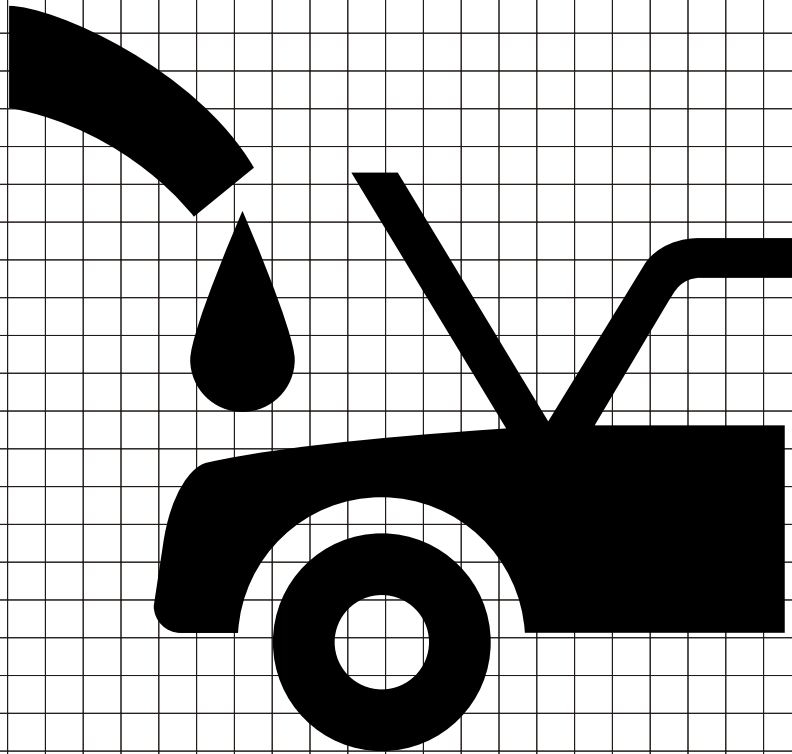

RS-114
Radiator Water

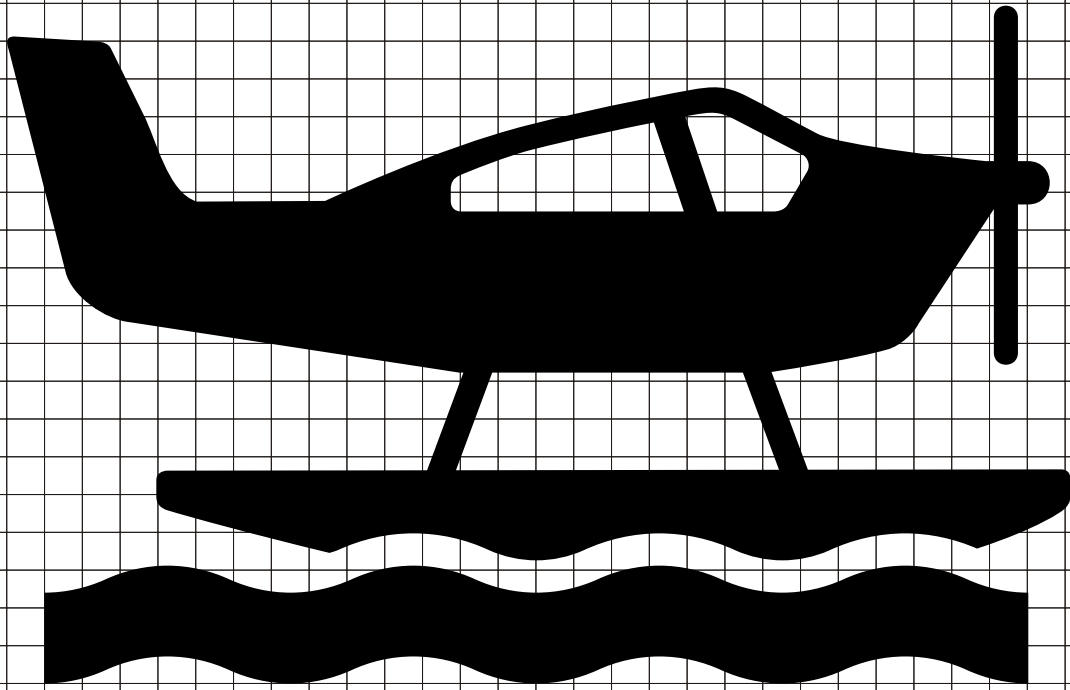

RS-115
Sea Plane

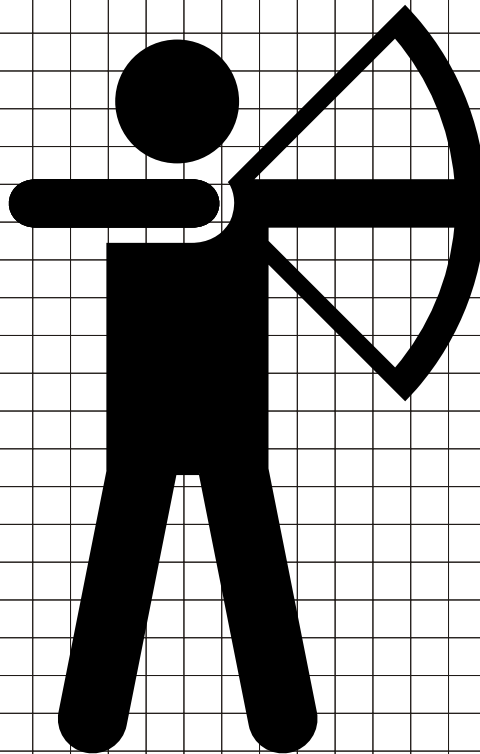

RS-116
Archery

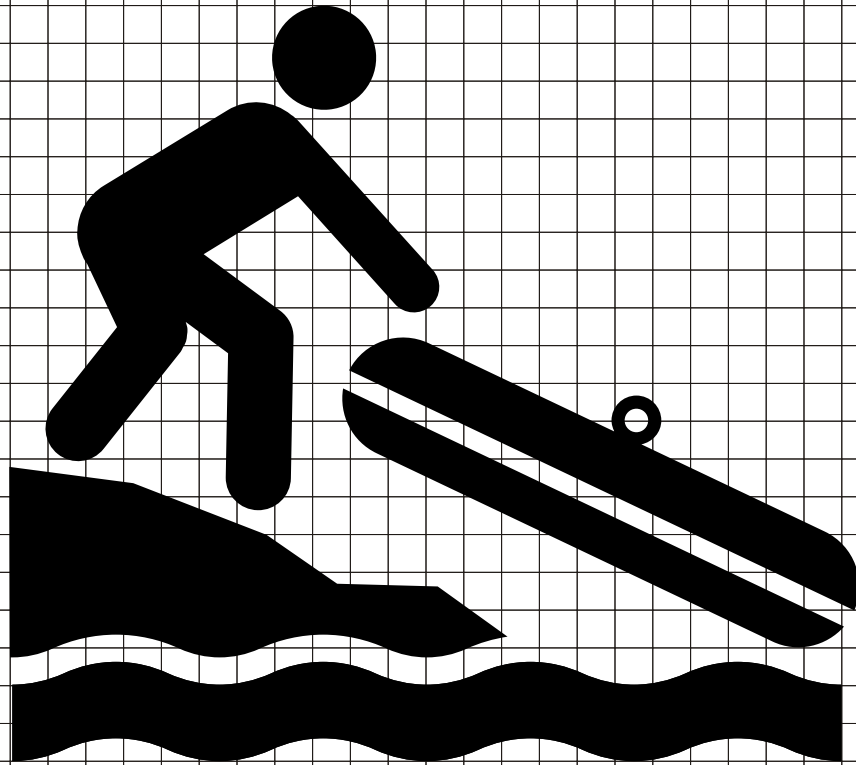

RS-117
**Hand Launch/
Small Boat Launch**

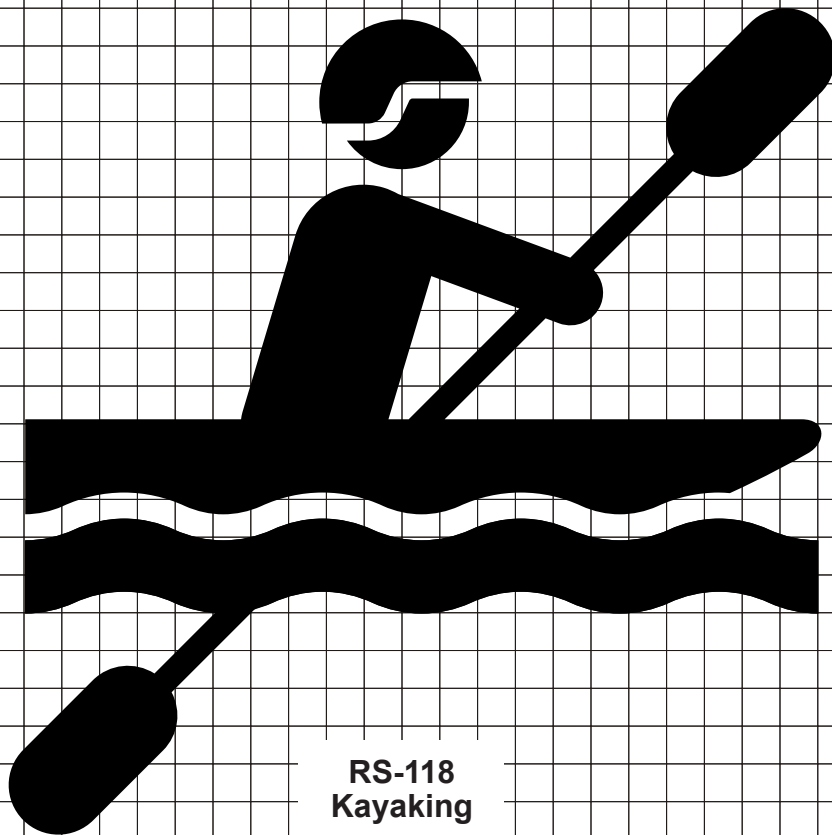

RS-118
Kayaking

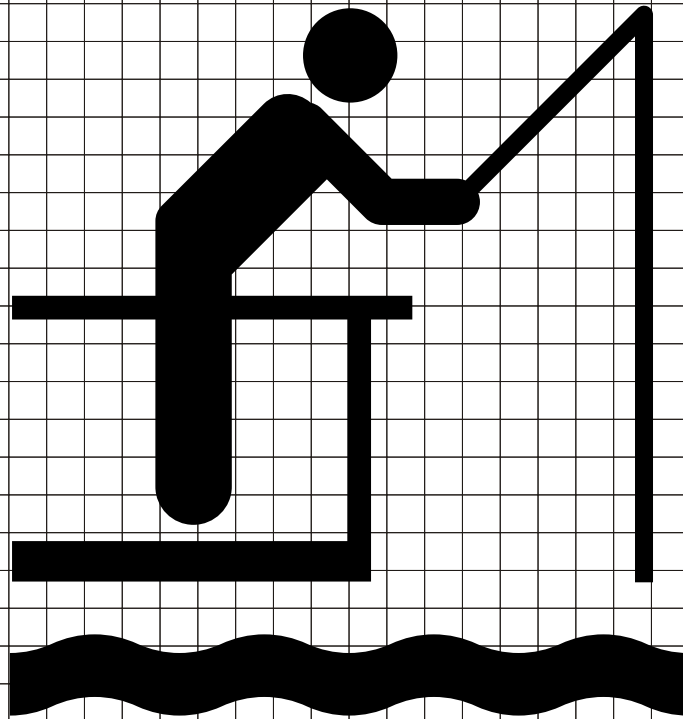

RS-119
Fishing Pier

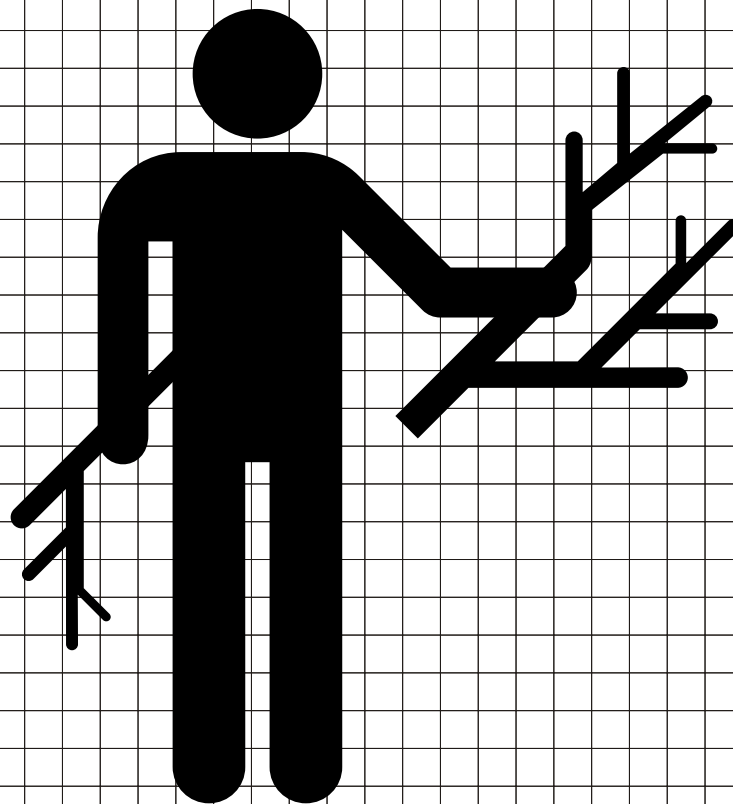

RS-120
Wood Gathering

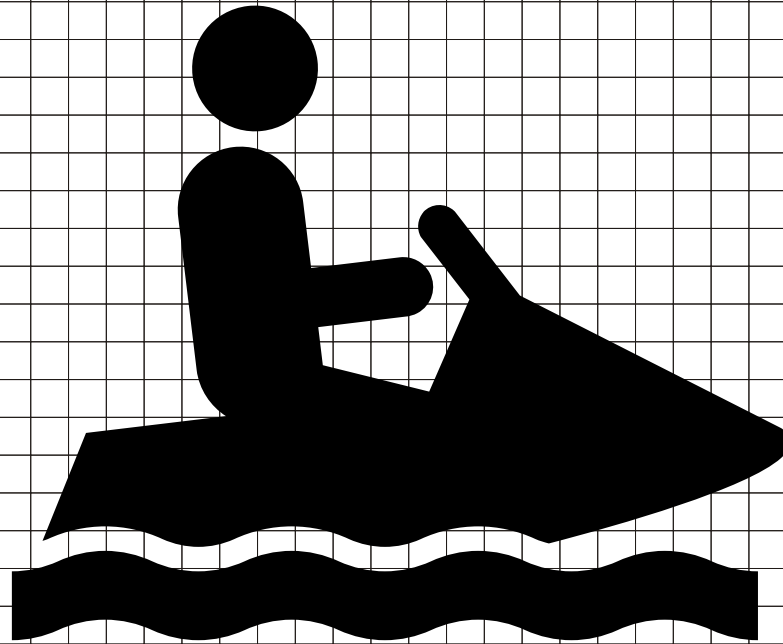

RS-121
Jet Ski/Personal
Watercraft

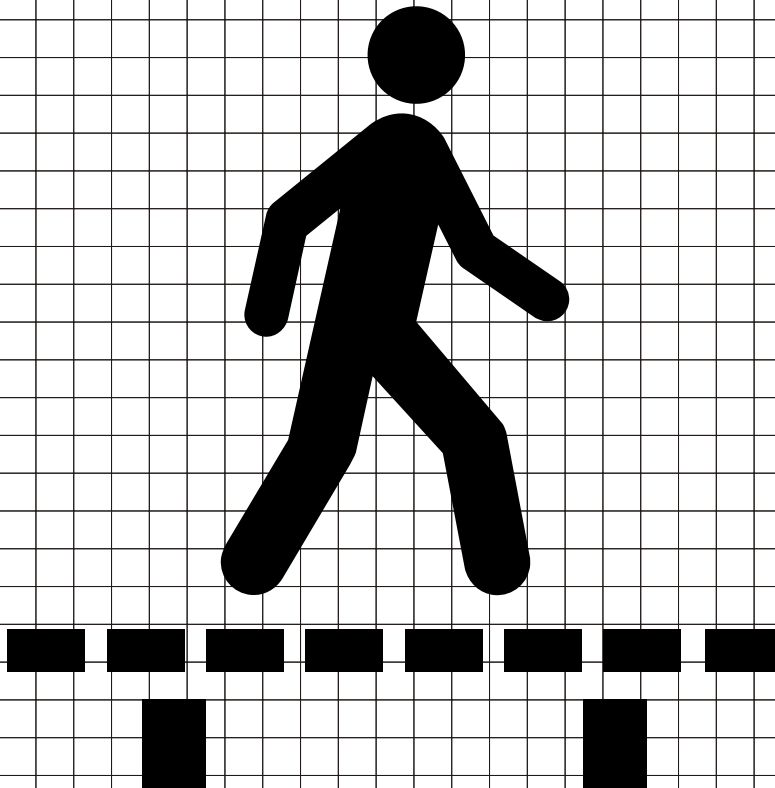

RS-122
Walk on Boardwalk

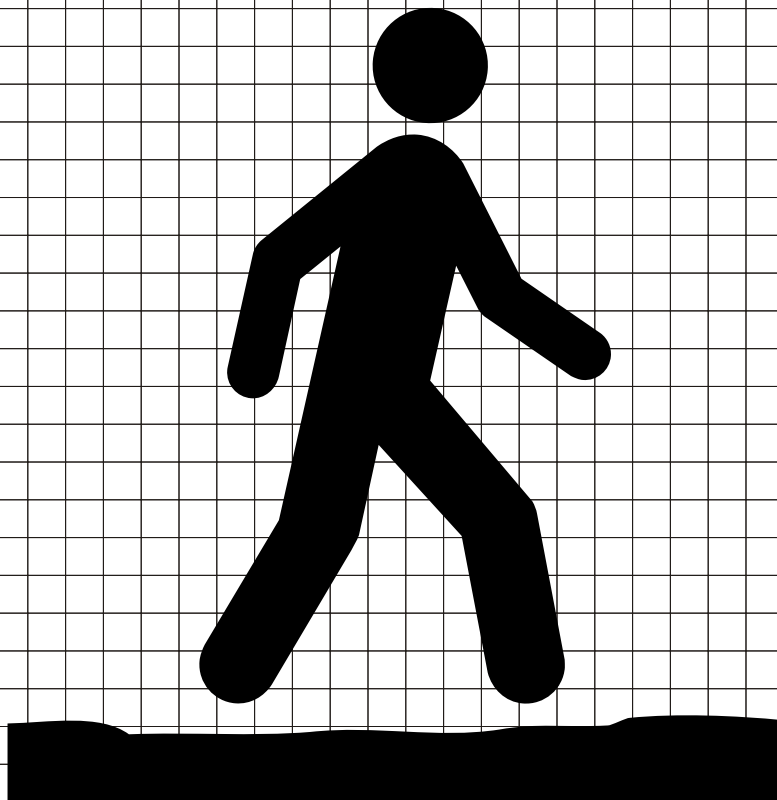

RS-123
Stay on Trail

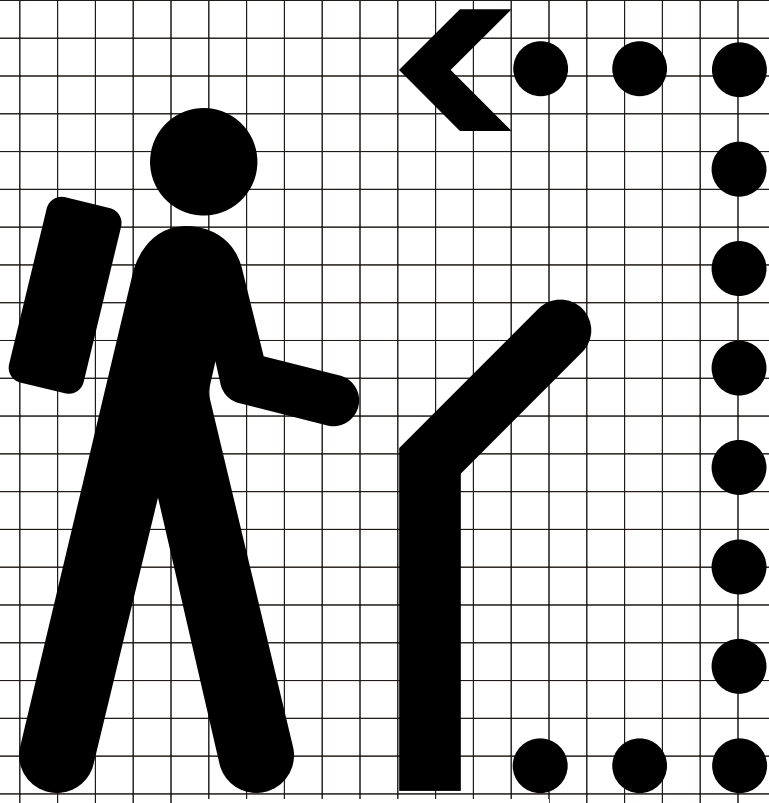

RS-124
Interpretive Trail

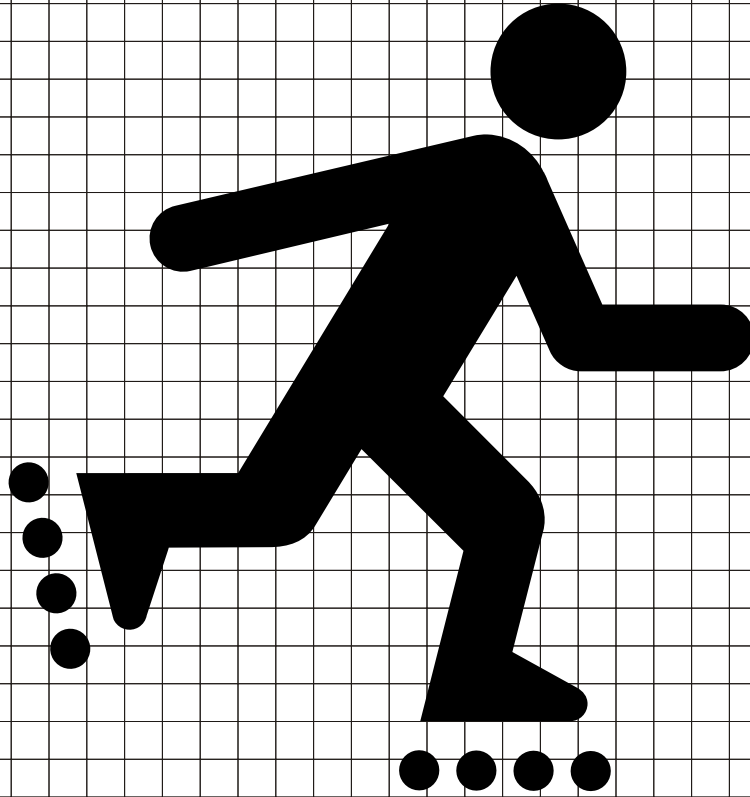

RS-125
In-Line Skating

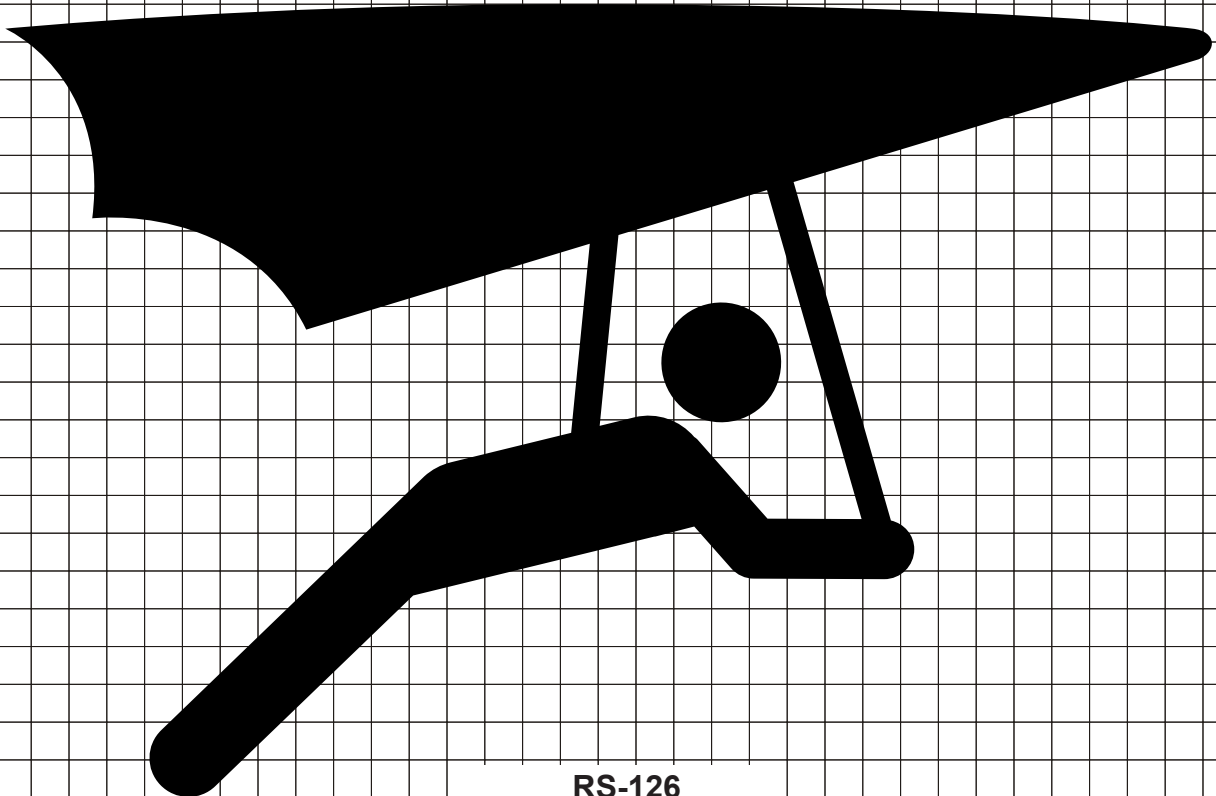

RS-126
Hang Gliding



RS-127
Snowboarding

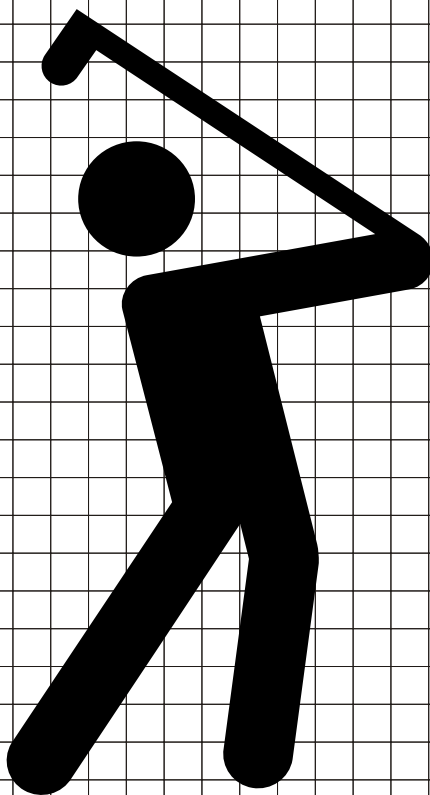

RS-128
Golfing

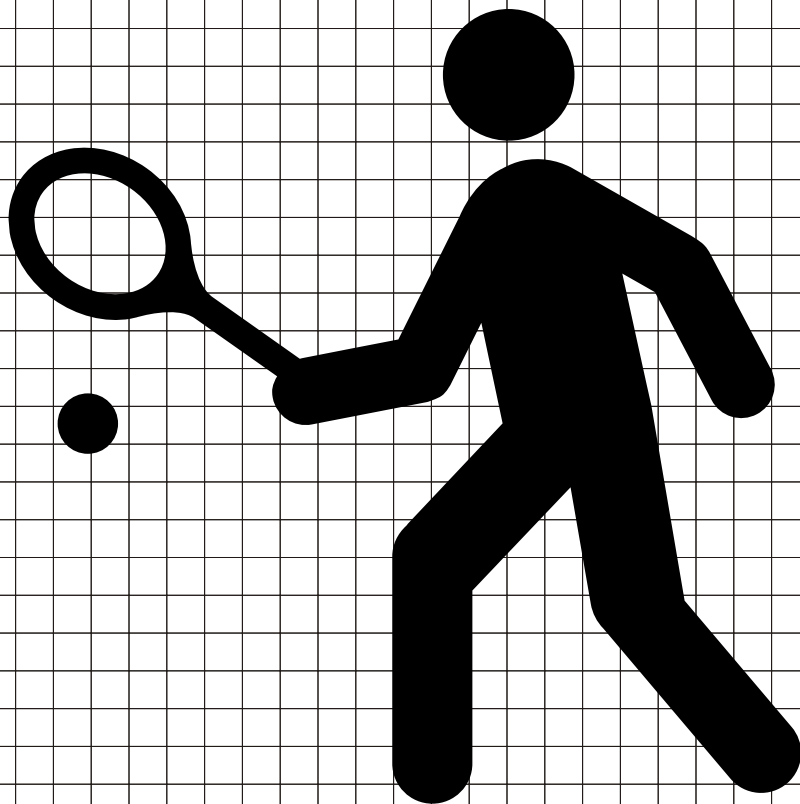

RS-129
Tennis

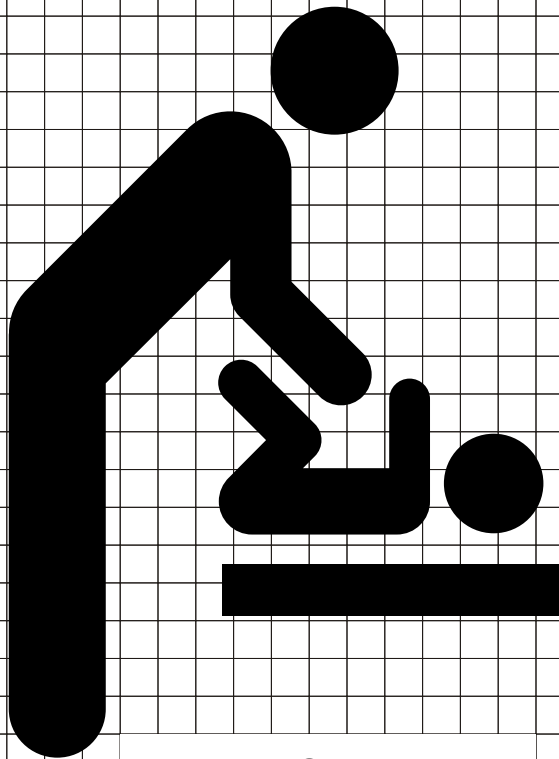

RS-137
Baby Changing Station
(Men's Room)

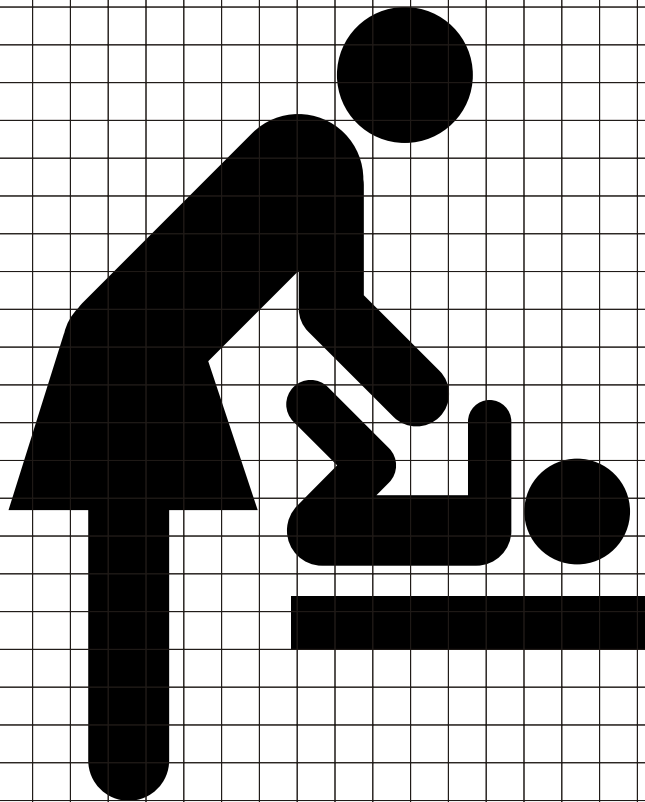

RS-138
Baby Changing Station
(Women's Room)

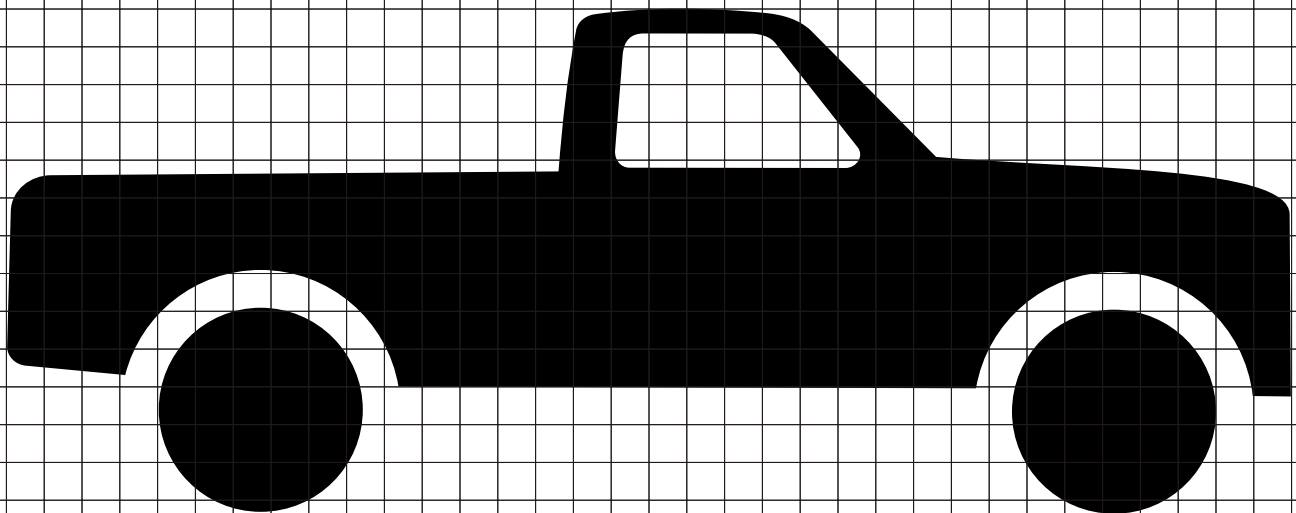

RS-140
Pick-up Trucks

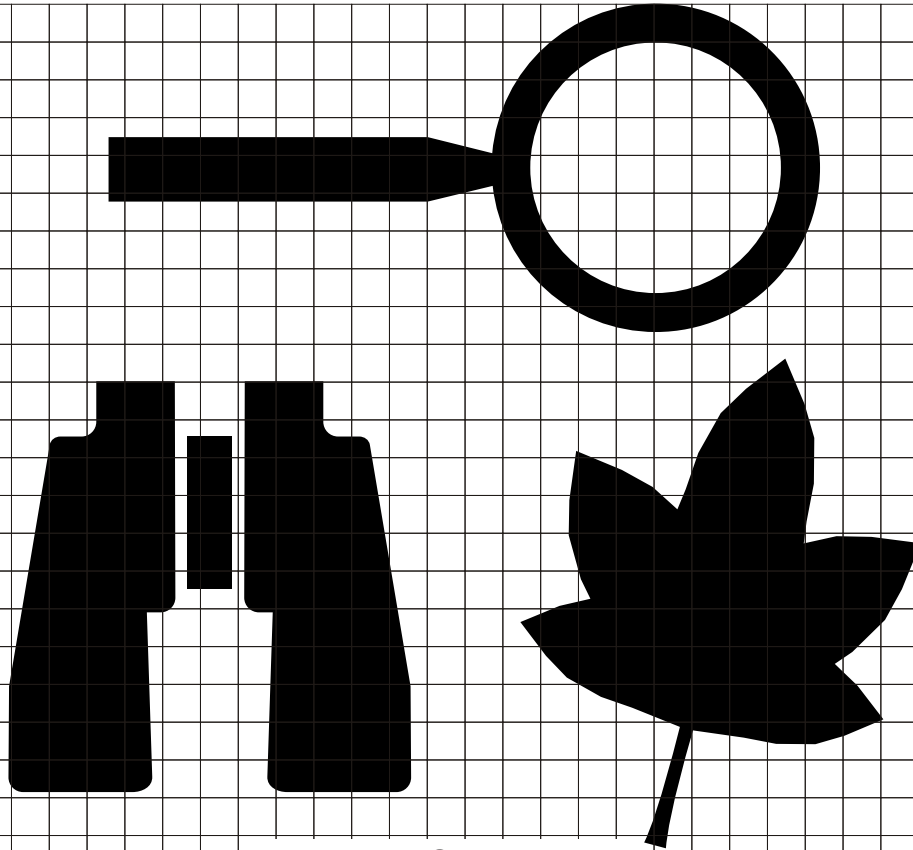

RS-141
Nature Study Area

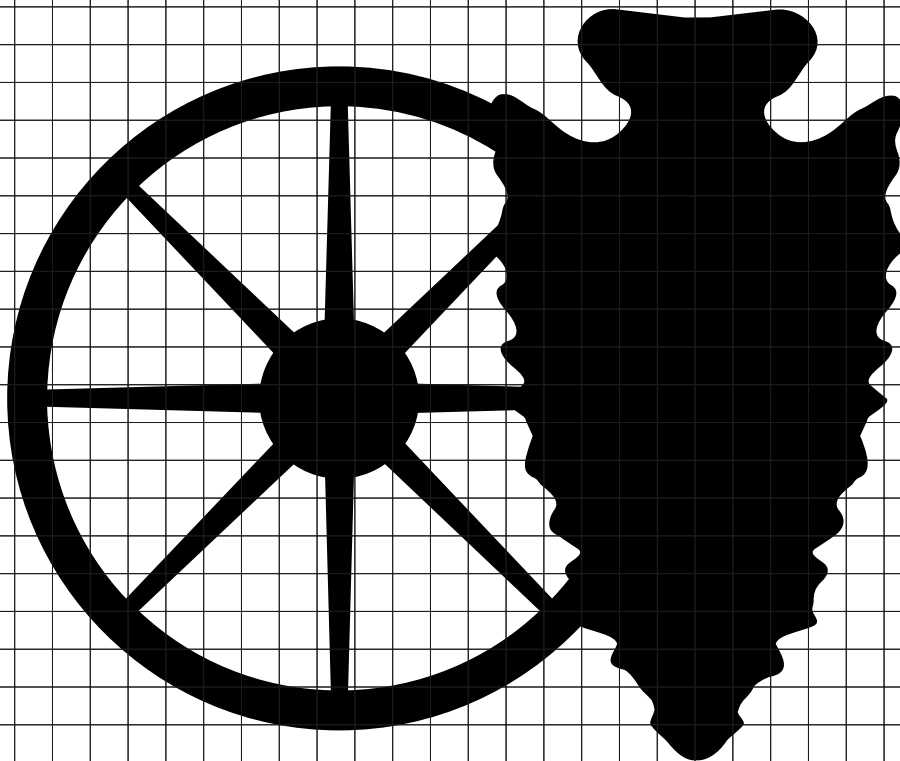

RS-142
Cultural Interest Area

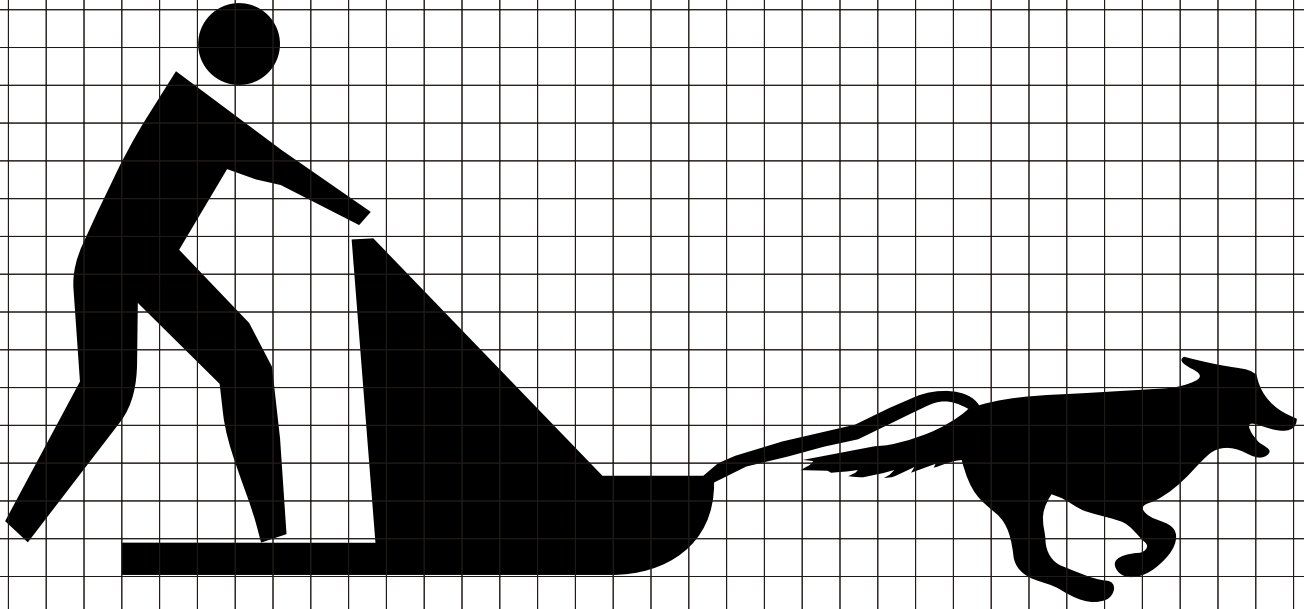

RS-143
Dog Sledding

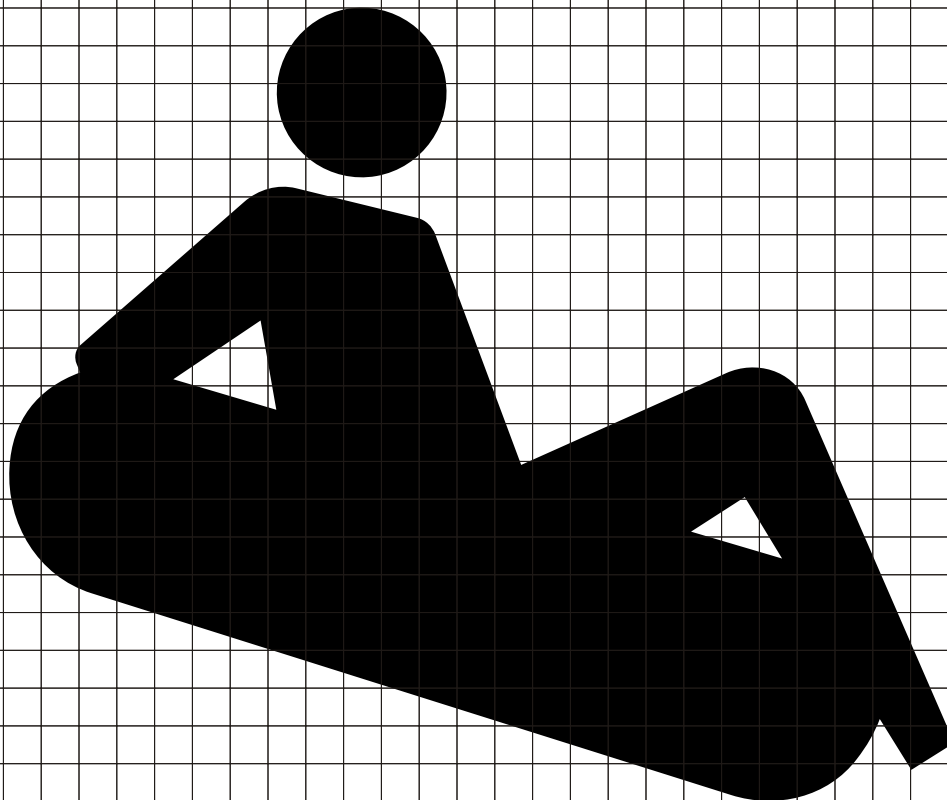

RS-144
Snow Tubing

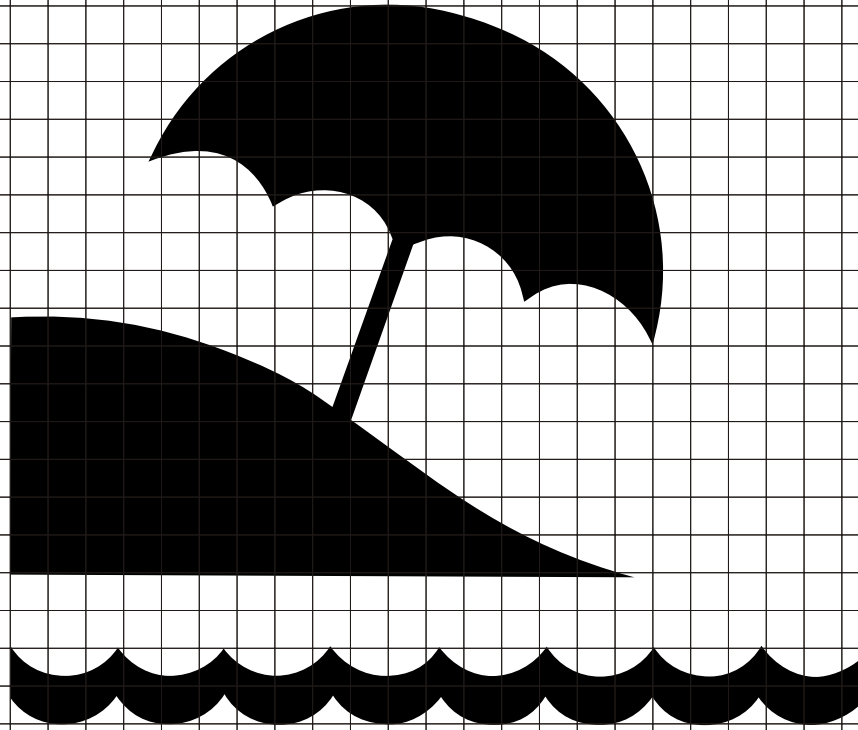

RS-145
Beach

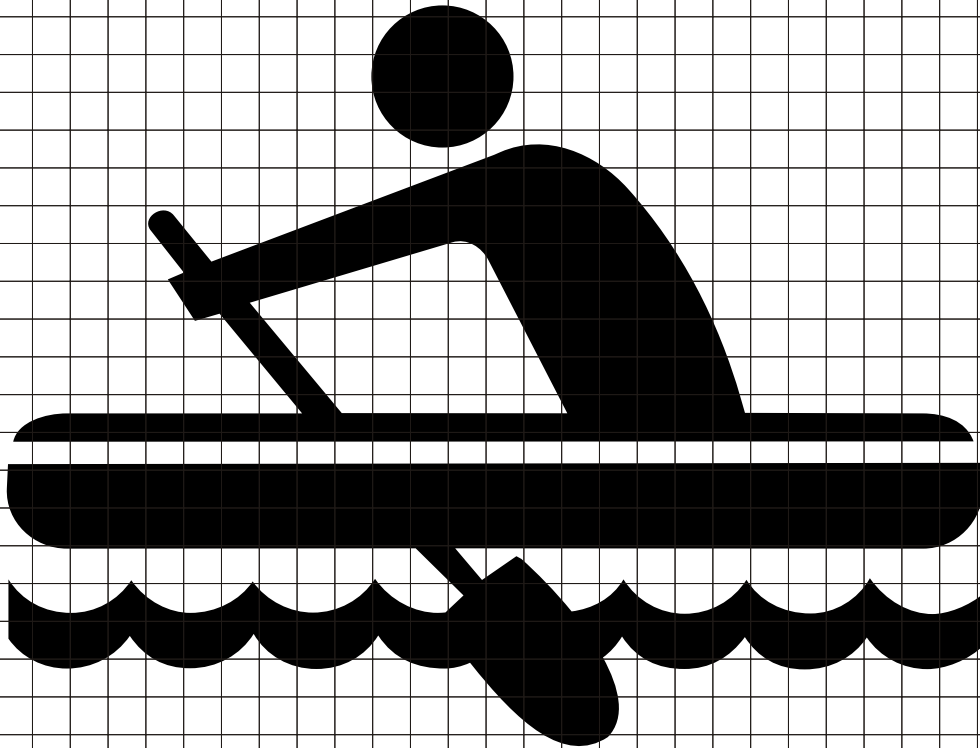

RS-146
Rafting

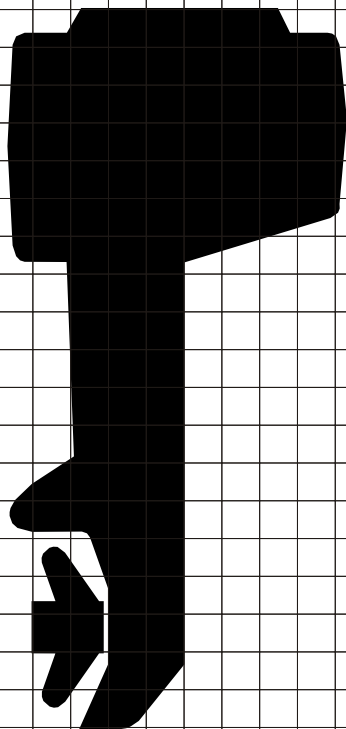

RS-147
Boat Motor

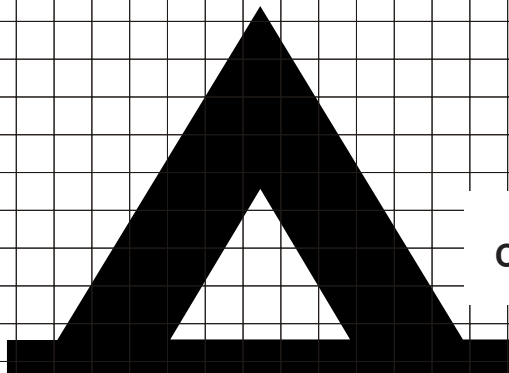

D9-3
Camping

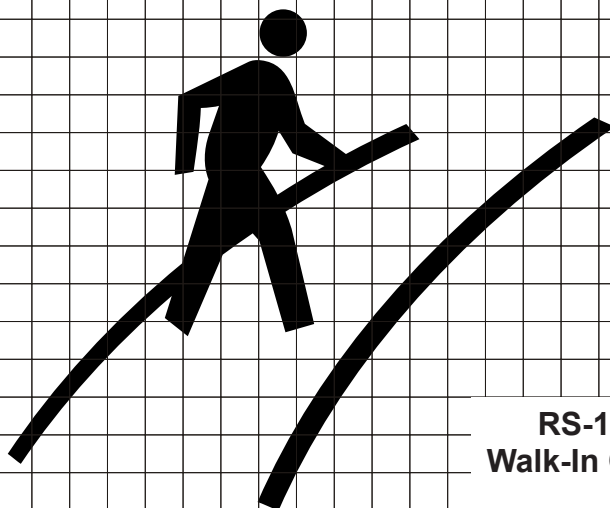

RS-148
Walk-In Camp

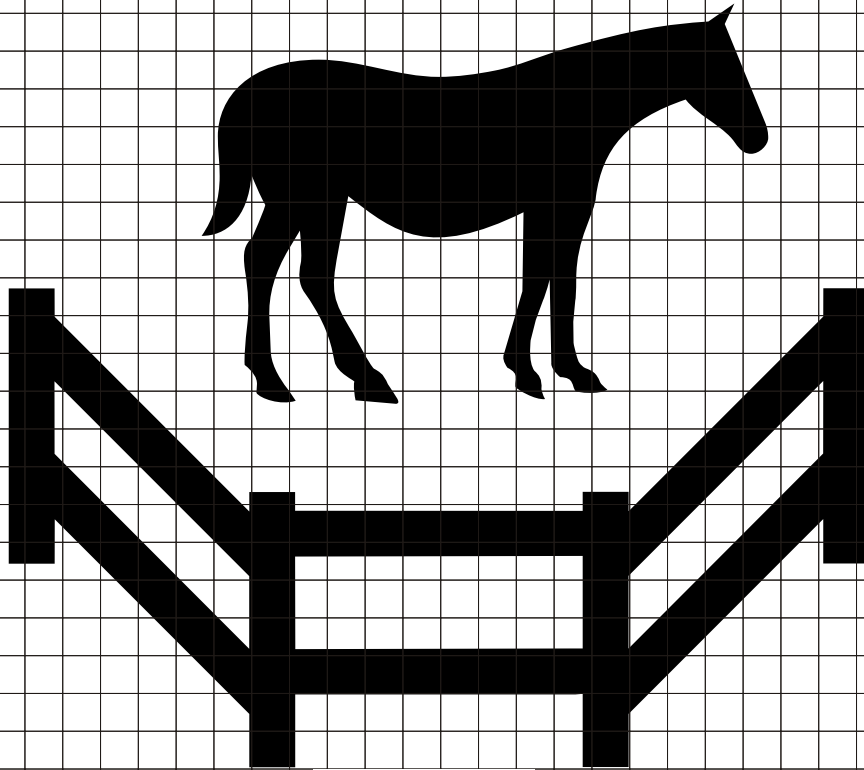

RS-149
Corral

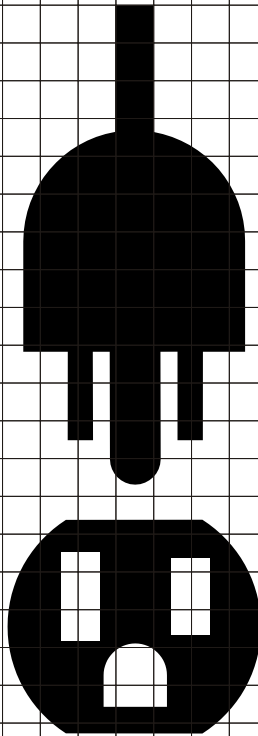

RS-150
Electrical Hook-Up

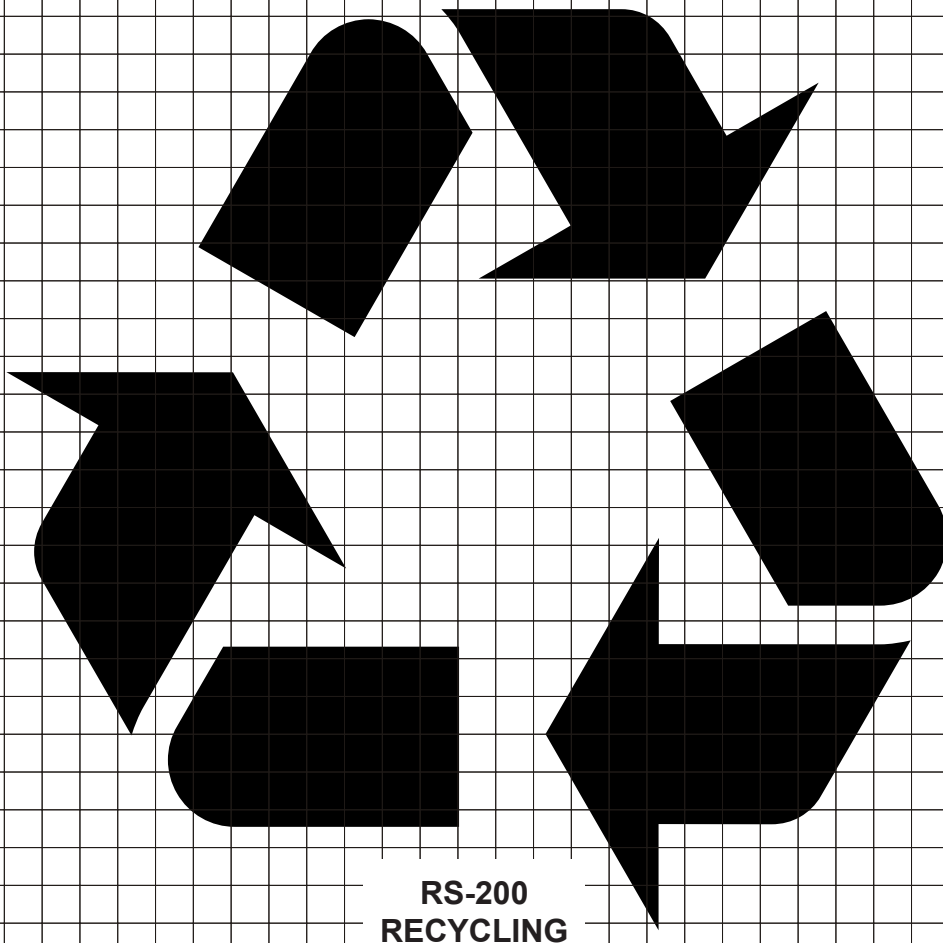

RS-200
RECYCLING

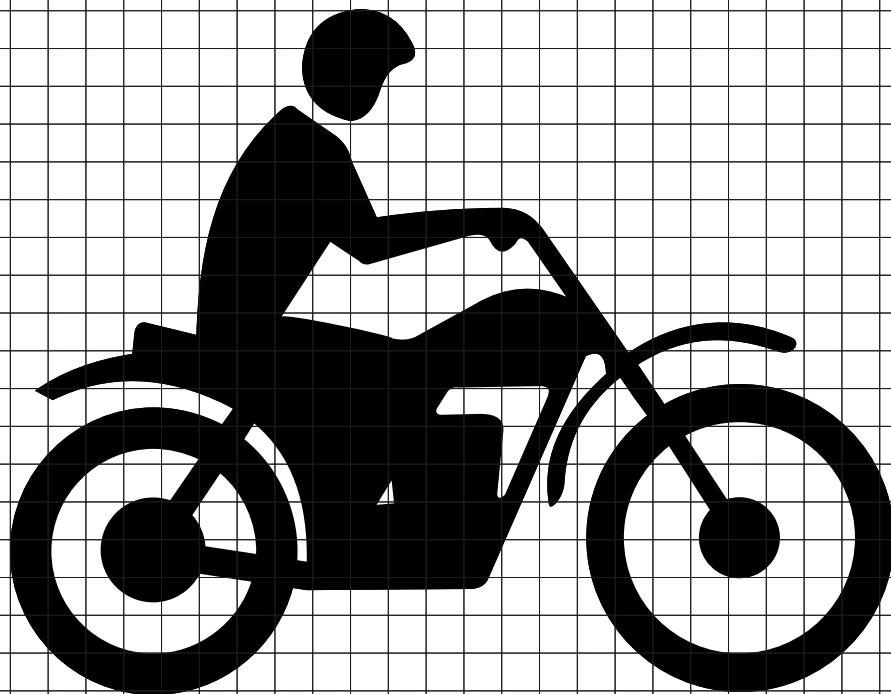

RS-300T
MOTORCYCLIST